

# NS8AT THRU NS8MT

## GLASS PASSIVATED GENERAL PURPOSE PLASTIC RECTIFIER

Reverse Voltage - 50 to 1000 Volts Forward Current - 8.0 Amperes

### TO-220AC

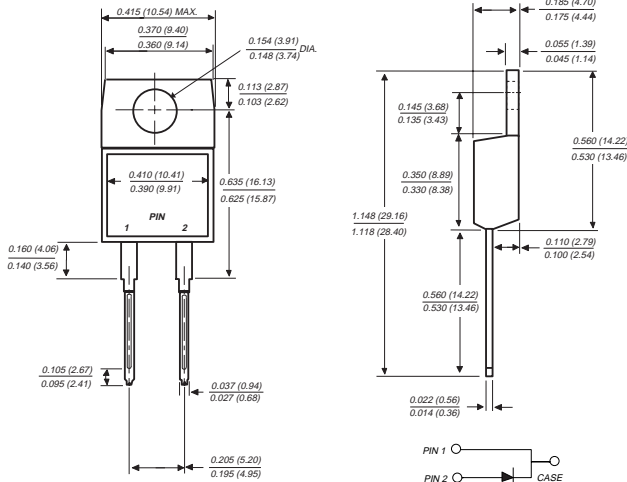

Dimensions in inches and (millimeters)

### FEATURES

- ◆ Plastic package has Underwriters Laboratory Flammability Classification 94V-0
- ◆ High forward current capability
- ◆ High surge current capability
- ◆ Low forward voltage drop
- ◆ Glass passivated chip junction
- ◆ High temperature soldering guaranteed: 260°C/10 seconds, 0.160" (4.06 mm) lead length

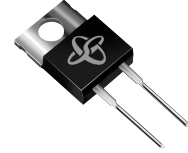

### MECHANICAL DATA

**Case:** JEDEC TO-220AB molded plastic body over passivated chip

**Terminals:** Plated leads solderable per MIL-STD-750, Method 2026

**Polarity:** As marked

**Mounting Torque:** 5 in. - lbs. max.

**Mounting Position:** Any

**Weight:** 0.064 ounce, 1.81 grams

## MAXIMUM RATINGS AND ELECTRICAL CHARACTERISTICS

Ratings at 25°C ambient temperature unless otherwise specified.

	SYMBOLS	NS8 AT	NS8 BT	NS8 DT	NS8 GT	NS8 JT	NS8 KT	NS8 MT	UNITS
Maximum repetitive peak reverse voltage	V <sub>RRM</sub>	50	100	200	400	600	800	1000	Volts
Maximum RMS voltage	V <sub>RMS</sub>	35	70	140	280	420	560	700	Volts
Maximum DC blocking voltage	V <sub>DC</sub>	50	100	200	400	600	800	1000	Volts
Maximum average forward rectified current at T <sub>C</sub> =100°C	I <sub>(AV)</sub>	8.0							Amps
Peak forward surge current 8.3ms single half sine-wave superimposed on rated load (JEDEC Method)	I <sub>FSM</sub>	125.0							Amps
Maximum instantaneous forward voltage at 8.0A	V <sub>F</sub>	1.1							Volts
Maximum DC reverse current at rated DC blocking voltage	I <sub>R</sub>	10.0 100.0							μA
Typical junction capacitance (NOTE 1)	C <sub>J</sub>	55.0							pF
Typical thermal resistance (NOTE 2)	R <sub>θJC</sub>	3.0							°C/W
Operating junction and storage temperature range	T <sub>J</sub> , T <sub>STG</sub>	-55 to +150							°C

### NOTES:

- (1) Measured at 1.0 MHz and applied reversed voltage of 4.0 Volts
- (2) Thermal resistance from junction to case mounted on heatsink

# RATINGS AND CHARACTERISTIC CURVES NS8AT THRU NS8MT

**FIG. 1 - FORWARD CURRENT DERATING CURVE**

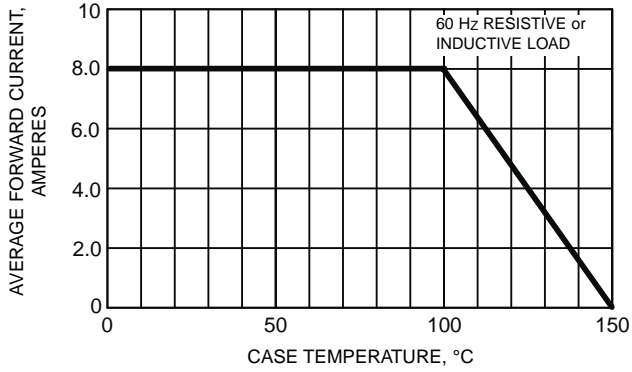

**FIG. 2 - MAXIMUM NON-REPETITIVE PEAK FORWARD SURGE CURRENT**

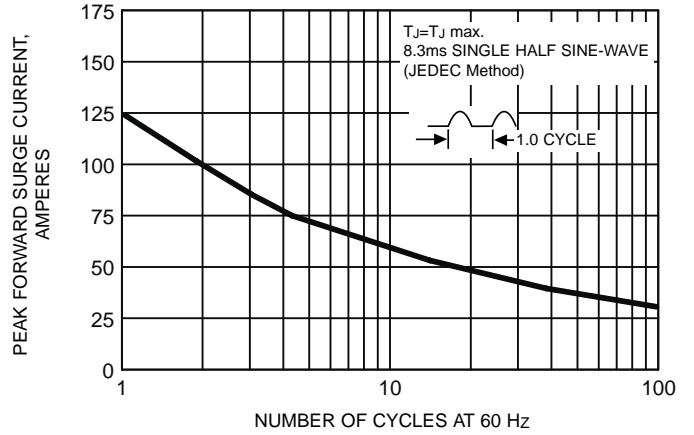

**FIG. 3 - TYPICAL INSTANTANEOUS FORWARD CHARACTERISTICS**

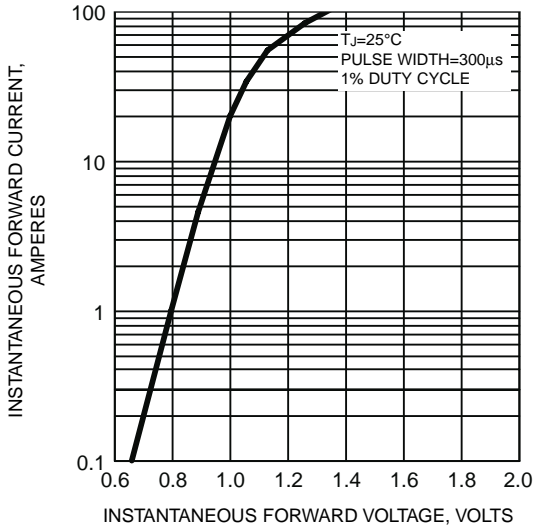

**FIG. 4 - TYPICAL REVERSE CHARACTERISTICS**

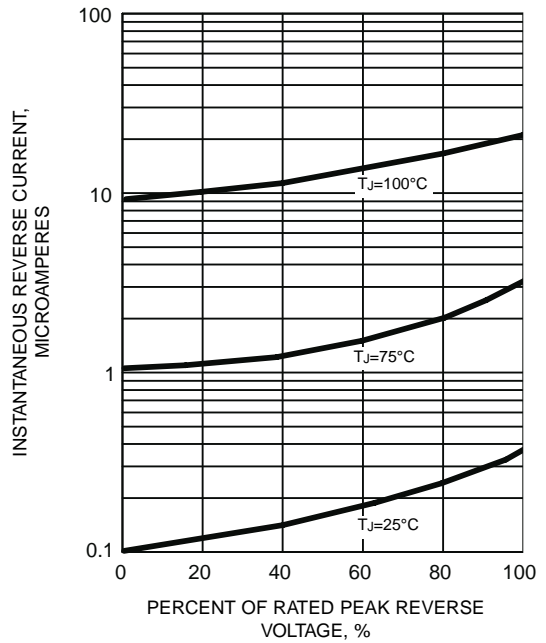

**FIG. 5 - TYPICAL JUNCTION CAPACITANCE**

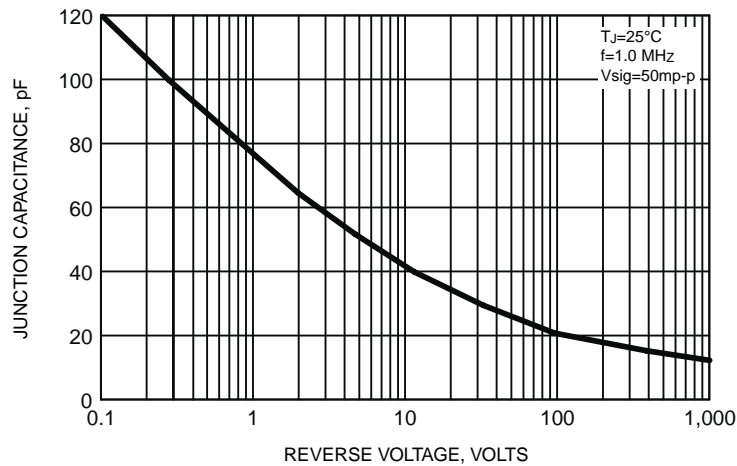

This datasheet has been download from:

[www.datasheetcatalog.com](http://www.datasheetcatalog.com)

Datasheets for electronics components.