

**Stacked Metallized PPS Film Chip Capacitor**

Type: **ECHU(C)**

Stacked metallized PPS film as dielectric with simple mold-less construction

■ **Features**

- Small in size
- Low loss and excellent frequency characteristics
- For reflow soldering
- RoHS directive compliant

■ **Recommended Applications**

- Time-constant
- Filtering
- Oscillation and resonance
- Resonance circuit for LCD backlight inverter unit

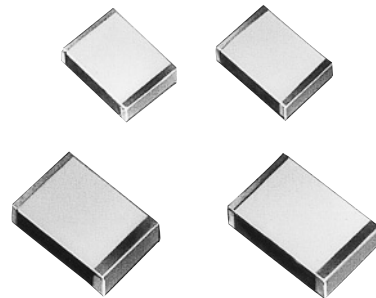

■ **Explanation of Numbers**

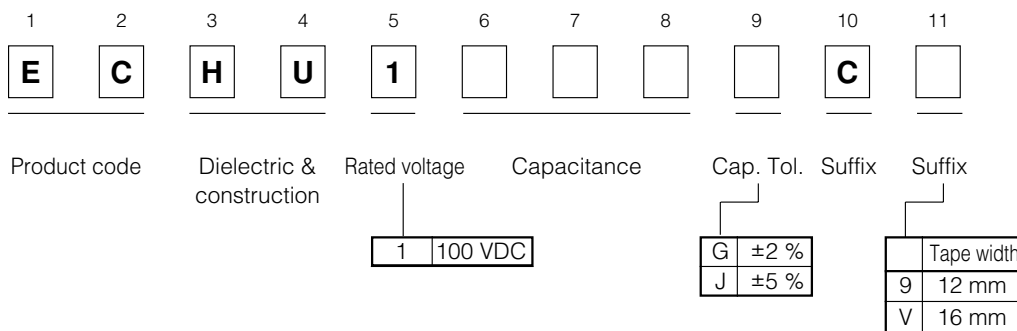

■ **Specifications**

Category temp. range (Including temperature-rise on unit surface)	-55 °C to +105 °C
Rated voltage	100 VDC
Capacitance range	0.010 μF to 0.22 μF(E12)
Capacitance tolerance	±2 %(G), ±5 %(J)
Withstand voltage	Between terminals : Rated volt. (VDC)×150 % 60 s
Dissipation factor (tanδ)	tan δ ≤0.6 % (20 °C, 1 kHz)
Insulation resistance (IR)	IR ≥3000 MΩ(20 °C, 100 VDC, 60 s)
Soldering conditions	Reflow soldering : 260 °C max. and 95 s max. at more than 220 °C (Temp. at cap. Surface)

\* In case of applying voltage in alternating current (50 Hz or 60 Hz sine wave) to a capacitor with DC rated voltage, please refer to the page of "Permissible voltage (R.M.S) in alternating current corresponding to DC rated voltage".

Chip

■ Construction

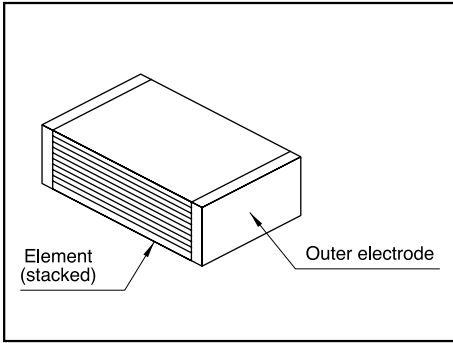

■ Dimensions in mm (not to scale)

size code	L	W	H
E1	4.8	3.3	1.4
E2	4.8	3.3	2.0
E3a	4.8	3.3	2.4
E3	4.8	3.3	2.8
D1	6.0	4.1	1.8
D2	6.0	4.1	2.0
D3	6.0	4.1	2.4
D4	6.0	4.1	2.8
D5	6.0	4.1	3.2
Z	7.1	5.0	*
Y	7.1	6.3	*

\* To be applied only for size Z&Y

\*Refer to the column "Rating,Dimensions&Quantity"

■ Taping Specification for Automatic Mounting

Refer to the page of taping specifications.

■ Rating, Dimensions & Quantity/Reel

● Capacitance tolerance: ±2 % (G), ±5 % (J)

Cap.(μF)	Rated volt. 100 VDC					Q'ty
	Part No.	Dimensions (mm)			Size Code	
		L	W	H		
0.010	ECHU1103□C9	4.8	3.3	1.4	E1	3000
0.012	ECHU1123□C9	4.8	3.3	1.4	E1	
0.015	ECHU1153□C9	4.8	3.3	2.0	E2	
0.018	ECHU1183□C9	4.8	3.3	2.0	E2	
0.022	ECHU1223□C9	4.8	3.3	2.4	E3a	2000
0.027	ECHU1273□C9	4.8	3.3	2.8	E3	
0.033	ECHU1333□C9	6.0	4.1	1.8	D1	3000
0.039	ECHU1393□C9	6.0	4.1	2.0	D2	
0.047	ECHU1473□C9	6.0	4.1	2.4	D3	
0.056	ECHU1563□C9	6.0	4.1	2.8	D4	2000
0.068	ECHU1683□C9	6.0	4.1	3.2	D5	
0.082	ECHU1823□C9	7.1	5.0	2.8	Z	1500
0.10	ECHU1104□C9	7.1	5.0	3.0	Z	
0.12	ECHU1124□C9	7.1	5.0	3.4	Z	
0.15	ECHU1154□CV	7.1	6.3	3.4	Y	1000
0.18	ECHU1184□CV	7.1	6.3	4.0	Y	
0.22	ECHU1224□CV	7.1	6.3	4.8	Y	

↑ Cap. tol. code

■ Recommended for Land Dimensions (mm)

Size code	Land dimensions		
	Reflow soldering		
	A	B	C
E1,E2,E3a,E3	2.6	6.6	3.0
D1,D2,D3,D4,D5	3.8	7.8	3.8
Z	4.5	9.0	4.6
Y	4.5	9.0	5.7

\* It is not warrantable that you can mount the capacitor without trouble under all the mounting condition when "Recommender for Land dimensions" is adopted.

Design, Specifications are subject to change without notice. Ask factory for technical specifications before purchase and/or use. Whenever a doubt about safety arises from this product, please inform us immediately for technical consultation without fail.

**ECHU (C) Type DC100V series (Stacked Metallized Film)**

**Electrical Characteristics <Typical Data >**

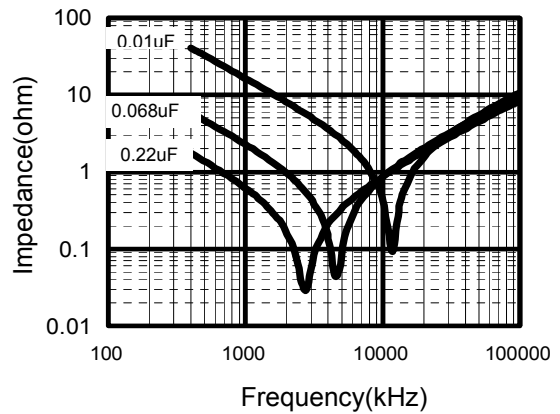
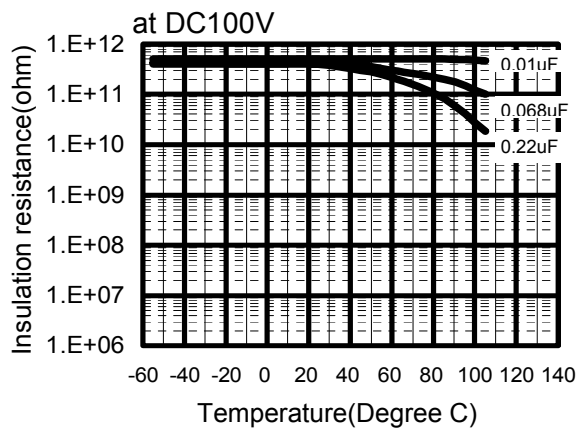
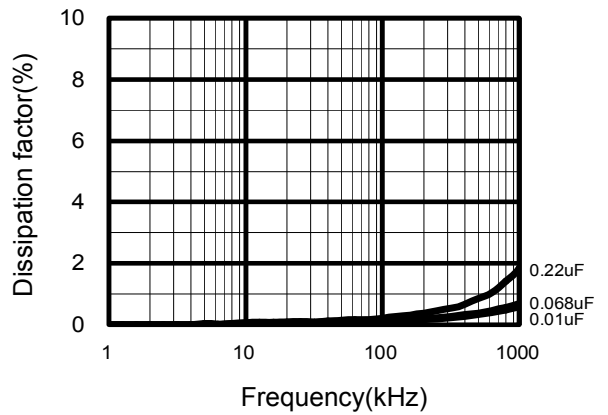
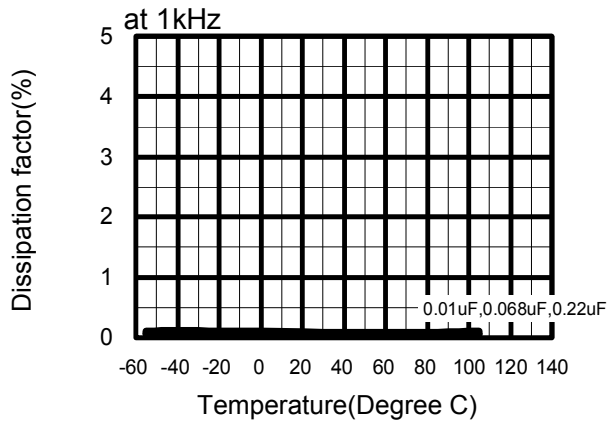
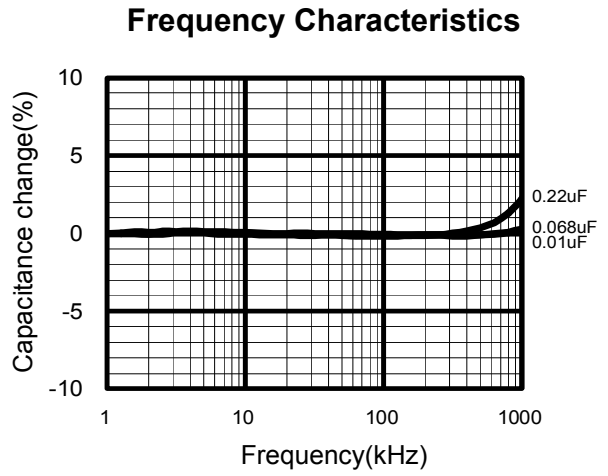
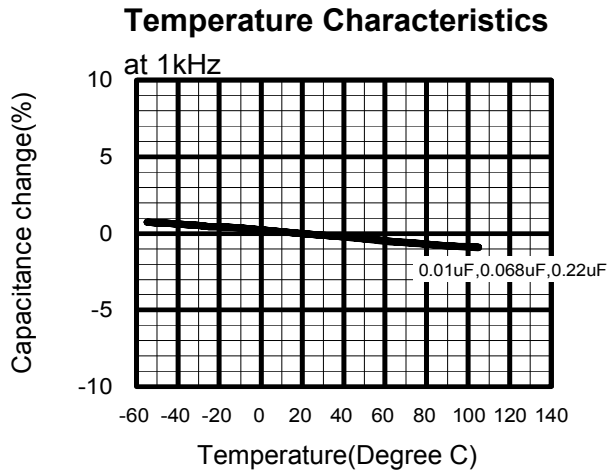

**ECHU (C) Type DC100V series (Stacked Metallized Film)**

**Applicable Specifications**

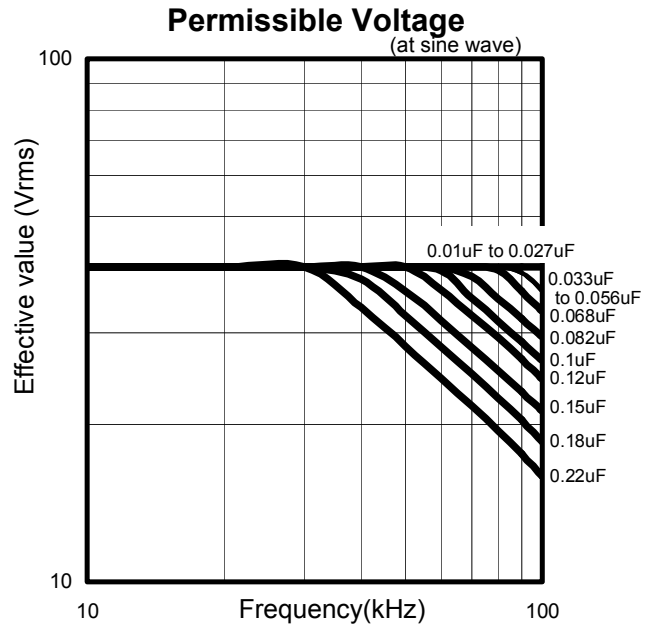
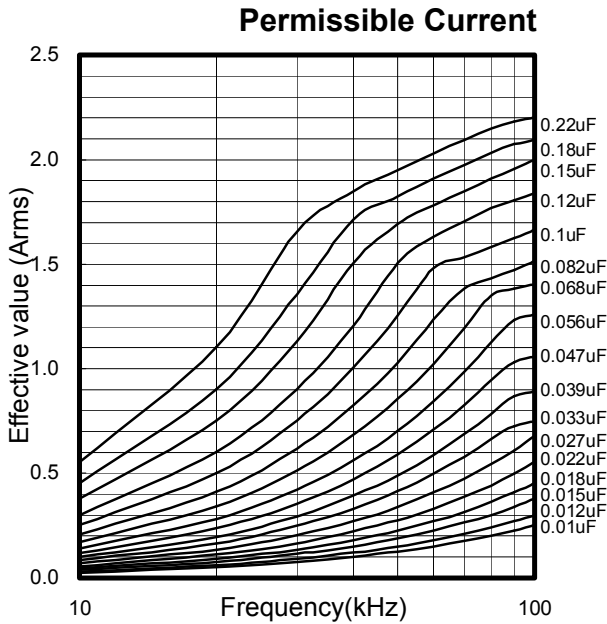

**Pulse Handling Capability (dv/dt)**  
(Max 10000cycles)

Rating Voltage	Capacitance Value(uF)	code	dV/dt (V/us)	Current(0-P) (A)
DC 100V	0.010	103	180	1.80
	0.012	123		2.16
	0.015	153		2.70
	0.018	183		3.24
	0.022	223		3.96
	0.027	273		4.86
	0.033	333	130	4.29
	0.039	393		5.07
	0.047	473		6.11
	0.056	563		7.28
	0.068	683	100	8.84
	0.082	823		8.20
	0.10	104		10.00
	0.12	124		12.00
	0.15	154		15.00
	0.18	184		18.00
0.22	224		22.00	

**Voltage Derating by Temperature**

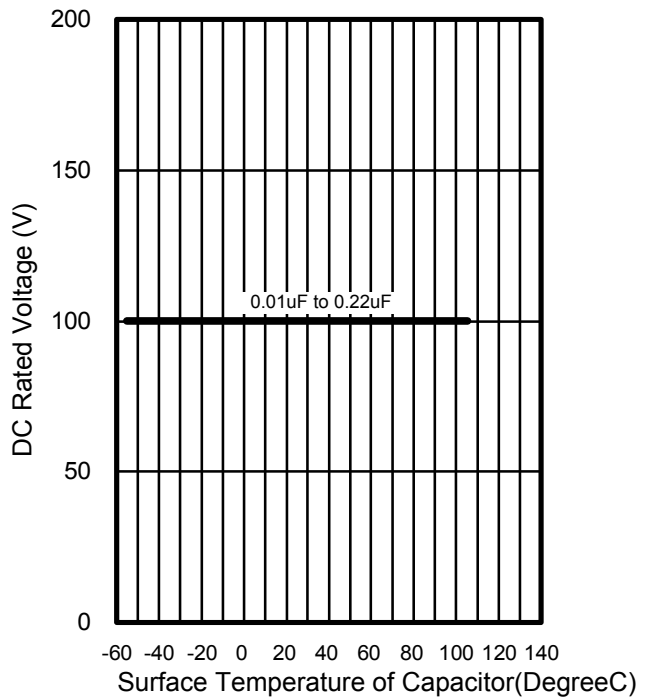

\*Please consult Panasonic if your condition exceeds the above

\*Permissible voltage graph is the case of sine waveform. When you use this product, peak voltage must not exceed DC rated voltage.

\*The current(0-P) value is calculated using nominal capacitance.