

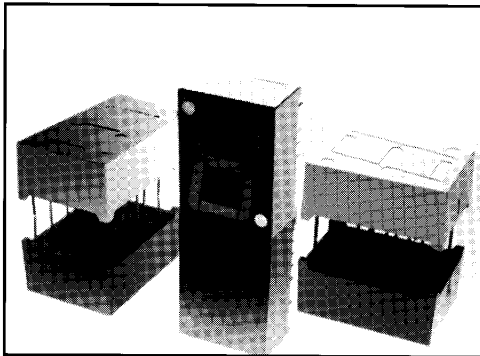

0.800-INCH SEVEN SEGMENT DISPLAYS

HIGH EFFICIENCY RED MAN8900 SERIES



DESCRIPTION

The MAN8900 Series is a family of large digits 0.8-inches in height. This series combines high brightness, large size, good aesthetics and is designed to be used where accurate readable displays need to be viewed over a distance. All models use right hand decimal points.

FEATURES

- High performance nitrogen-doped GaAsP on GaP
- Large, easy to read, digits
- Common anode or common cathode models
- Fast switching — excellent for multiplexing
- Low power consumption
- Bold solid segments that are highly legible
- Solid state reliability — long operation life
- Rugged plastic construction
- Directly compatible with integrated circuits
- High brightness with high contrast
- Categorized for Luminous Intensity (See Note 6)
- Wide angle viewing ... 150°
- Low forward voltage
- Red face and Red segment for good ON or OFF contrast
- These devices have a Red face and Red segments

APPLICATIONS

- For industrial and consumer applications such as:
- Digital readout displays
 - Instrument panels
 - Point of sale equipment
 - Digital clocks
 - TV and radios

MODEL NUMBERS

PART NUMBER	COLOR	DESCRIPTION	PACKAGE DRAWING
MAN8910	High Efficiency Red	Common Anode; Right Hand Decimal	1
MAN8940	High Efficiency Red	Common Cathode; Right Hand Decimal	1

RECOMMENDED FILTERS

For optimum ON and OFF contrast, one of the following filters or equivalents should be used over the display:

Panelgraphic Scarlet 65
Homalite 100-1670



0.800-INCH SEVEN SEGMENT DISPLAYS

ELECTRO-OPTICAL CHARACTERISTICS (25°C Free Air Temperature Unless Otherwise Specified)					
	MIN.	TYP.	MAX.	UNITS	TEST CONDITIONS
Luminous Intensity, digit average (See Note 1)	600	2200		μ cd	$I_f = 10$ mA
Peak emission wavelength		635		nm	
Spectral line half width		40		nm	
Forward voltage Segment			2.5	V	$I_f = 20$ mA
Decimal point			2.5	V	$I_f = 20$ mA
Dynamic resistance Segment		26		Ω	$I_f = 20$ mA
Decimal point		26		Ω	$I_f = 20$ mA
Capacitance Segment		35		pF	V=0
Decimal point		35		pF	V=0
Reverse current Segment			100	μ A	$V_R = 3.0$ V
Decimal point			100	μ A	$V_R = 3.0$ V
Luminous Intensity Ratio I_L (segment-to-segment)			2:1	—	$I_f = 10$ mA

ABSOLUTE MAXIMUM RATINGS	
Power dissipation at 25°C ambient	600 mW
Derate linearly from 50°C	-8.6 mW/°C
Storage and operating temperature	-40°C to +85°C
Continuous forward current	
Total	240 mA
Per segment	30 mA
Decimal point	30 mA
Reverse voltage	
Per segment	6.0 V
Decimal point	6.0 V
Soldering time at 260°C (See Note 4)	5 sec.
Peak forward current per segment (I_{max}) (See Figure 4)	—

TYPICAL THERMAL CHARACTERISTICS	
Thermal resistance junction to free air Φ_{JA}	160°C/W
Wavelength temperature coefficient (case temperature)	1.0Å/°C
Forward voltage temperature coefficient	-2.0 mV/°C

- | NOTES | |
|---|--|
| <ol style="list-style-type: none"> 1. The digit average Luminous Intensity is obtained by summing the Luminous Intensity of each segment and dividing by the total number of segments. Intensity will not vary more than $\pm 33.3\%$ between all segments within a digit. 2. The curve in Figure 3 is normalized to the brightness at 25°C to indicate the relative efficiency over the operating temperature range. 3. Leads of the device immersed to 1/16 inch from the body. Maximum device surface temperature is 140°C. 4. For flux removal, Freon TF, Freon TE, Isoproponal or water may be used up to their boiling points. 5. All displays are categorized for Luminous Intensity. The Intensity category is marked on each part as a suffix letter to the part number. | |

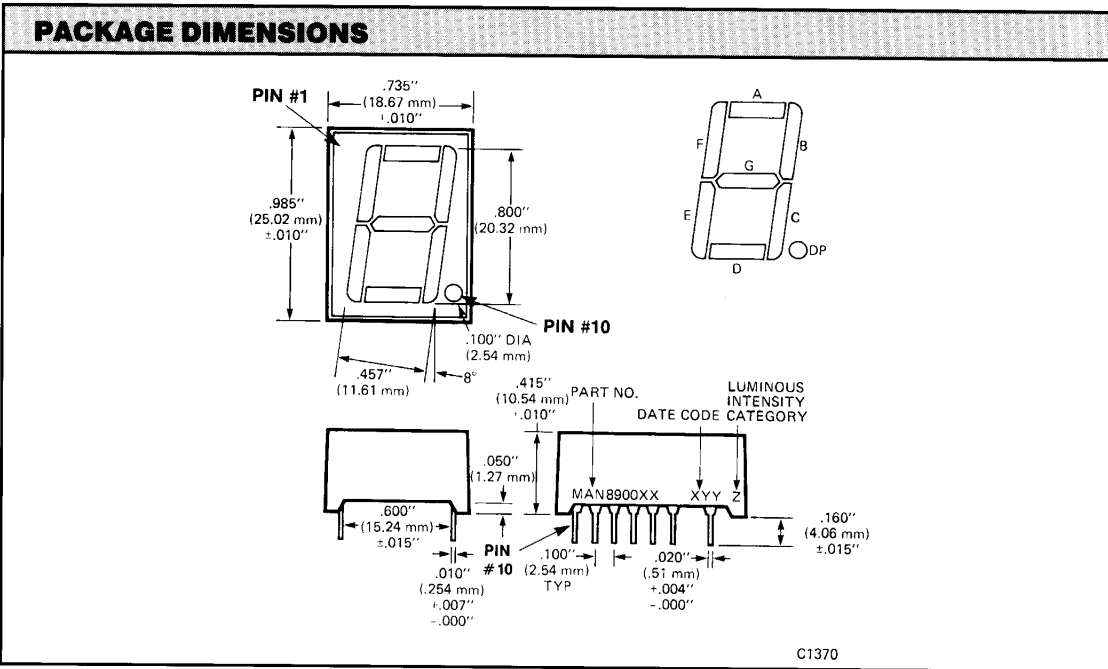

ELECTRICAL CONNECTIONS

ELECTRICAL CONNECTIONS		
	MAN8910	MAN8940
	Digit	Digit
	Common Anode	Common Cathode
PIN #	Package Dimensions	Package Dimensions
1	No Connection	No Connection
2	A Cathode	A Anode
3	F Cathode	F Anode
4	Common Anode	Common Cathode
5	E Cathode	E Anode
6	—	—
7	E Cathode	E Anode
8	—	—
9	D Cathode	Common Cathode
10	DP Cathode	DP Anode
11	D Cathode	D Anode
12	Common Anode	Common Cathode
13	C Cathode	C Anode
14	G Cathode	G Anode
15	B Cathode	B Anode
16	—	—
17	Common Anode	Common Cathode
18	—	—

TYPICAL CHARACTERISTIC CURVES

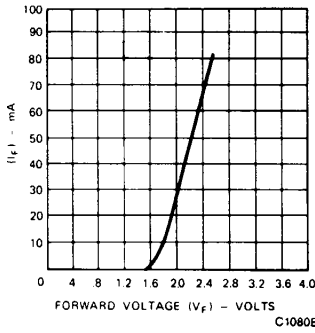

Fig. 1. Forward Current vs. Forward Voltage

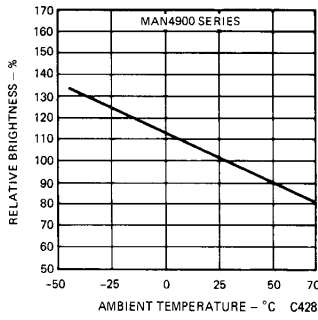

Fig. 2. Luminous Intensity vs. Temperature (See Note 2)

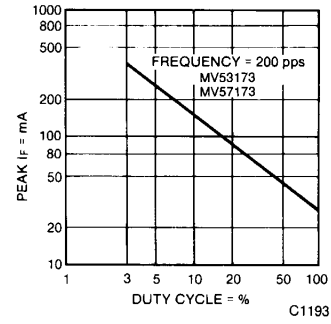

Fig. 3. Max Peak Current vs. Duty Cycle

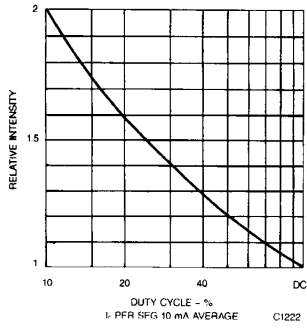

Fig. 4. Luminous Intensity vs. Duty Cycle

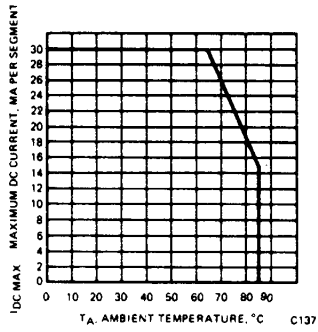

Fig. 5. Maximum DC Current vs. Temperature

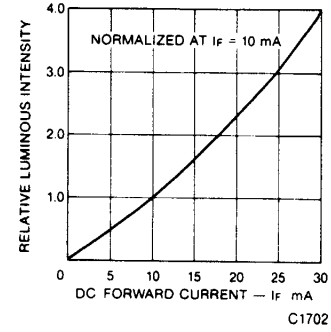

Fig. 6. Relative Luminous Intensity vs. Forward Current

INTERNAL CONNECTIONS

