

High Speed Infrared Emitting Diode, 870 nm, GaAIAs Double Hetero

Description

The TSHA650. series are high efficiency infrared emitting diodes in GaAIAs on GaAIAs technology, molded in a clear, untinted plastic package.

In comparison with the standard GaAs on GaAs technology these high intensity emitters feature about 70 % radiant power improvement.

In contrast to the TSHA550. series lead stand-offs are omitted.

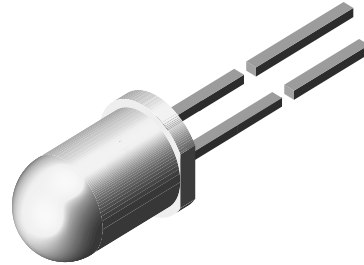

94 8389

Features

- Extra high radiant power
- Suitable for high pulse current operation
- Standard T-1 $\frac{3}{4}$ (\varnothing 5 mm) package
- Leads formed without stand-off
- Angle of half intensity $\phi = \pm 24^\circ$
- Peak wavelength $\lambda_p = 875$ nm
- High reliability
- Good spectral matching to Si photodetectors
- Lead-free component
- Component in accordance to RoHS 2002/95/EC and WEEE 2002/96/EC

Applications

Infrared remote control and free air transmission systems with high power and comfortable radiation angle requirements in combination with PIN photodiodes or phototransistors.

Because of the reduced radiance absorption in glass at the wavelength of 875 nm, this emitter series is also suitable for systems with panes in the transmission range between emitter and detector.

Absolute Maximum Ratings

$T_{amb} = 25^\circ\text{C}$, unless otherwise specified

Parameter	Test condition	Symbol	Value	Unit
Reverse Voltage		V_R	5	V
Forward current		I_F	100	mA
Peak Forward Current	$t_p/T = 0.5$, $t_p = 100 \mu\text{s}$	I_{FM}	200	mA
Surge Forward Current	$t_p = 100 \mu\text{s}$	I_{FSM}	2.5	A
Power Dissipation		P_V	210	mW
Junction Temperature		T_j	100	$^\circ\text{C}$
Operating Temperature Range		T_{amb}	- 55 to + 100	$^\circ\text{C}$
Storage Temperature Range		T_{stg}	- 55 to + 100	$^\circ\text{C}$
Soldering Temperature	$t \leq 5$ sec, 2 mm from case	T_{sd}	260	$^\circ\text{C}$
Thermal Resistance Junction/ Ambient		R_{thJA}	350	K/W

Electrical Characteristics

$T_{amb} = 25\text{ }^{\circ}\text{C}$, unless otherwise specified

Parameter	Test condition	Symbol	Min	Typ.	Max	Unit
Forward Voltage	$I_F = 100\text{ mA}$, $t_p = 20\text{ ms}$	V_F		1.5	1.8	V
Temp. Coefficient of V_F	$I_F = 100\text{ mA}$	TK_{V_F}		-1.6		mV/K
Reverse Current	$V_R = 5\text{ V}$	I_R			100	μA
Junction capacitance	$V_R = 0\text{ V}$, $f = 1\text{ MHz}$, $E = 0$	C_j		20		pF

Optical Characteristics

$T_{amb} = 25\text{ }^{\circ}\text{C}$, unless otherwise specified

Parameter	Test condition	Symbol	Min	Typ.	Max	Unit
Temp. Coefficient of ϕ_e	$I_F = 20\text{ mA}$	$TK\phi_e$		-0.7		%/K
Angle of Half Intensity		ϕ		± 24		deg
Peak Wavelength	$I_F = 100\text{ mA}$	λ_p		875		nm
Spectral Bandwidth	$I_F = 100\text{ mA}$	$\Delta\lambda$		80		nm
Temp. Coefficient of λ_p	$I_F = 100\text{ mA}$	$TK\lambda_p$		0.2		nm/K
Rise Time	$I_F = 100\text{ mA}$	t_r		600		ns
	$I_F = 1.5\text{ A}$	t_r		300		ns
Fall Time	$I_F = 100\text{ mA}$	t_f		600		ns
	$I_F = 1.5\text{ A}$	t_f		300		ns
Virtual Source Diameter		\emptyset		2.2		mm

Type Dedicated Characteristics

$T_{amb} = 25\text{ }^{\circ}\text{C}$, unless otherwise specified

Parameter	Test condition	Part	Symbol	Min	Typ.	Max	Unit
Forward Voltage	$I_F = 1.5\text{ A}$, $t_p = 100\text{ }\mu\text{s}$	TSHA6500	V_F		3.2	4.9	V
		TSHA6501	V_F		3.2	4.9	V
		TSHA6502	V_F		3.2	4.5	V
		TSHA6503	V_F		3.2	4.5	V
Radiant Intensity	$I_F = 100\text{ mA}$, $t_p = 20\text{ ms}$	TSHA6500	I_e	12	20	60	mW/sr
		TSHA6501	I_e	16	25	60	mW/sr
		TSHA6502	I_e	20	30	60	mW/sr
		TSHA6503	I_e	24	35	60	mW/sr
	$I_F = 1.5\text{ A}$, $t_p = 100\text{ }\mu\text{s}$	TSHA6500	I_e	150	240		mW/sr
		TSHA6501	I_e	200	300		mW/sr
		TSHA6502	I_e	250	360		mW/sr
		TSHA6503	I_e	300	420		mW/sr
Radiant Power	$I_F = 100\text{ mA}$, $t_p = 20\text{ ms}$	TSHA6500	ϕ_e		22		mW
		TSHA6501	ϕ_e		23		mW
		TSHA6502	ϕ_e		24		mW
		TSHA6503	ϕ_e		25		mW

Typical Characteristics ($T_{amb} = 25\text{ }^{\circ}\text{C}$ unless otherwise specified)

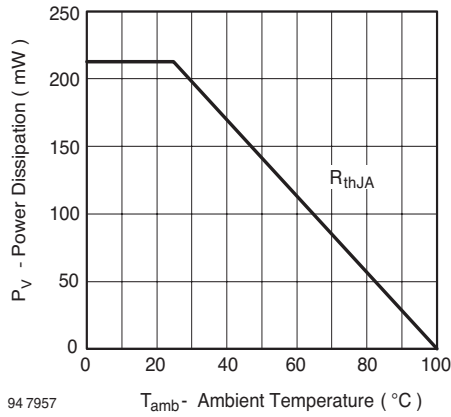

Figure 1. Power Dissipation vs. Ambient Temperature

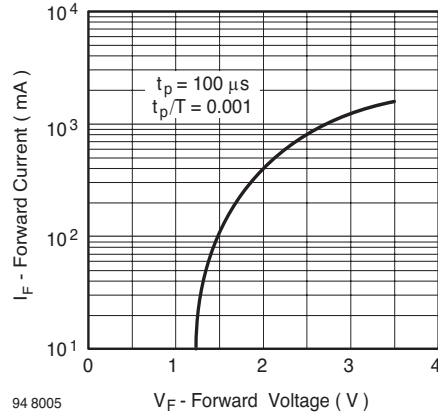

Figure 4. Forward Current vs. Forward Voltage

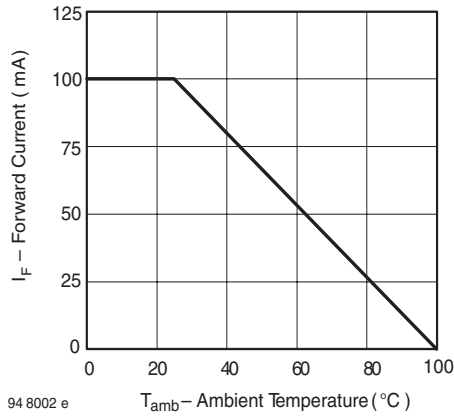

Figure 2. Forward Current vs. Ambient Temperature

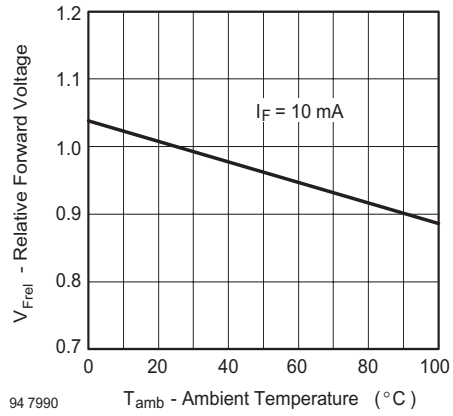

Figure 5. Relative Forward Voltage vs. Ambient Temperature

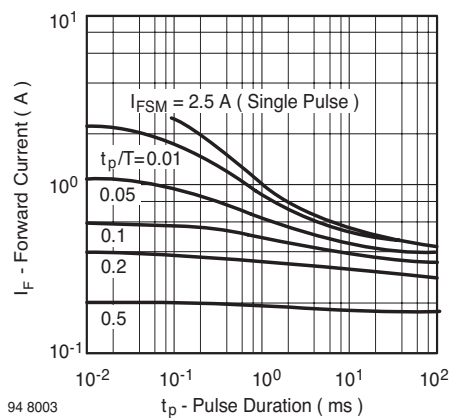

Figure 3. Pulse Forward Current vs. Pulse Duration

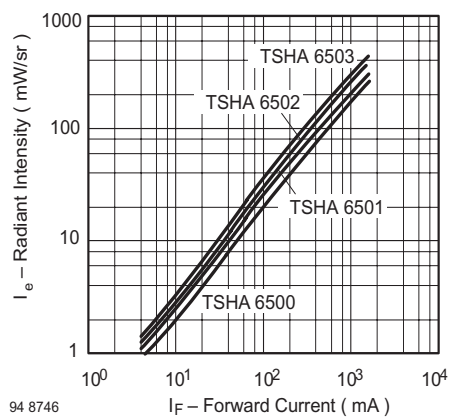

Figure 6. Radiant Intensity vs. Forward Current

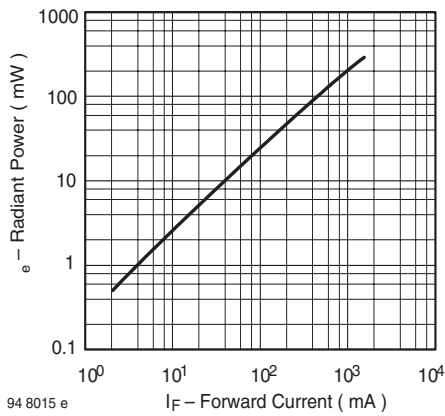

Figure 7. Radiant Power vs. Forward Current

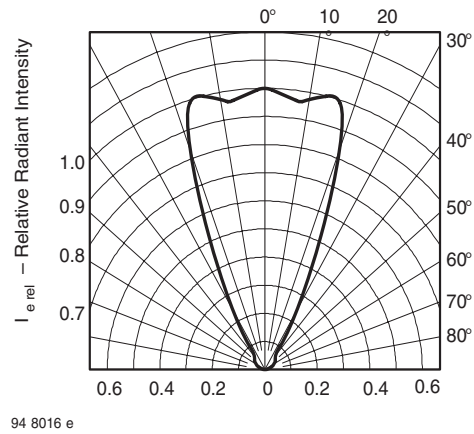

Figure 10. Relative Radiant Intensity vs. Angular Displacement

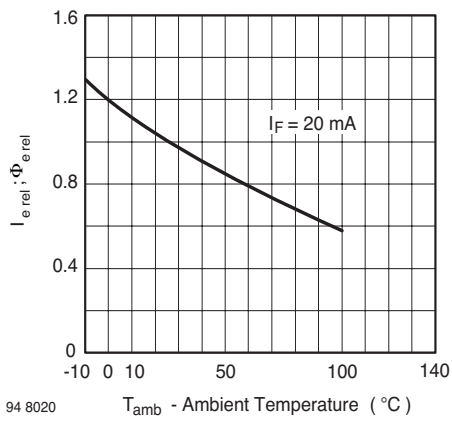

Figure 8. Rel. Radiant Intensity/Power vs. Ambient Temperature

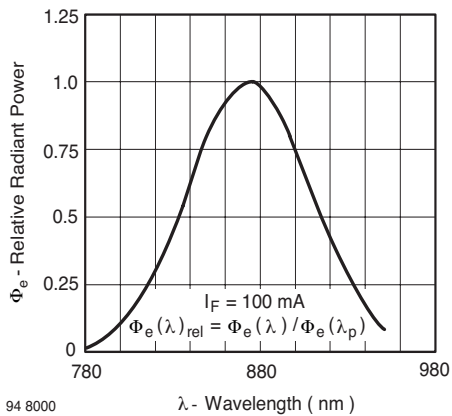
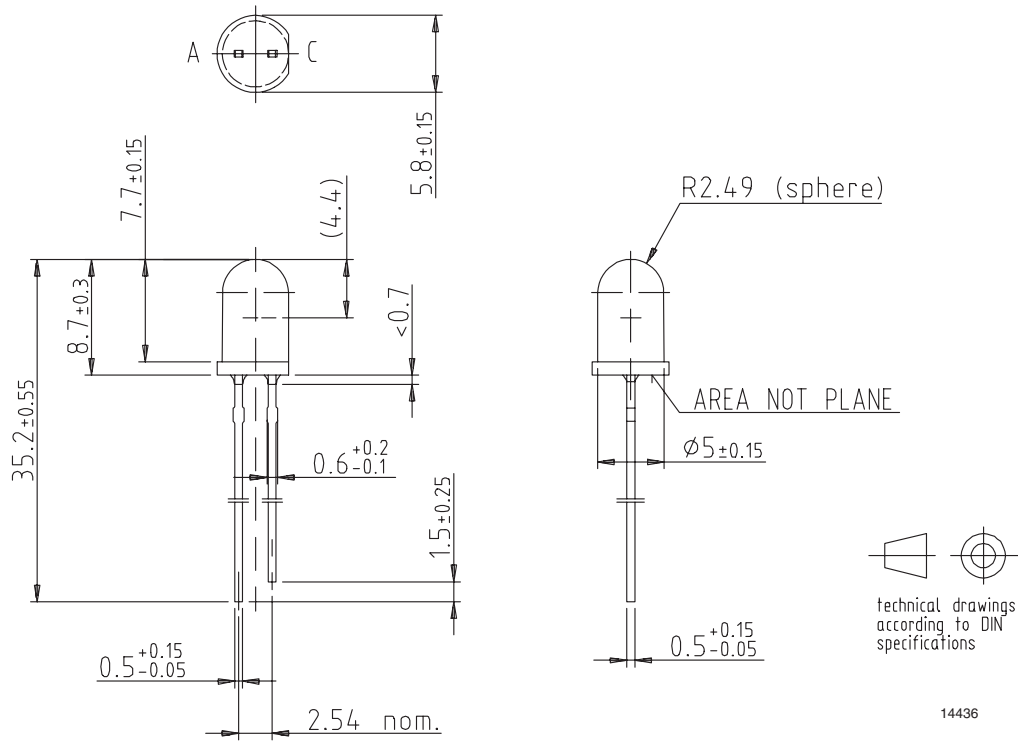

Figure 9. Relative Radiant Power vs. Wavelength

Package Dimensions in mm



Ozone Depleting Substances Policy Statement

It is the policy of Vishay Semiconductor GmbH to

1. Meet all present and future national and international statutory requirements.
2. Regularly and continuously improve the performance of our products, processes, distribution and operating systems with respect to their impact on the health and safety of our employees and the public, as well as their impact on the environment.

It is particular concern to control or eliminate releases of those substances into the atmosphere which are known as ozone depleting substances (ODSs).

The Montreal Protocol (1987) and its London Amendments (1990) intend to severely restrict the use of ODSs and forbid their use within the next ten years. Various national and international initiatives are pressing for an earlier ban on these substances.

Vishay Semiconductor GmbH has been able to use its policy of continuous improvements to eliminate the use of ODSs listed in the following documents.

1. Annex A, B and list of transitional substances of the Montreal Protocol and the London Amendments respectively
2. Class I and II ozone depleting substances in the Clean Air Act Amendments of 1990 by the Environmental Protection Agency (EPA) in the USA
3. Council Decision 88/540/EEC and 91/690/EEC Annex A, B and C (transitional substances) respectively.

Vishay Semiconductor GmbH can certify that our semiconductors are not manufactured with ozone depleting substances and do not contain such substances.

We reserve the right to make changes to improve technical design
and may do so without further notice.

Parameters can vary in different applications. All operating parameters must be validated for each customer application by the customer. Should the buyer use Vishay Semiconductors products for any unintended or unauthorized application, the buyer shall indemnify Vishay Semiconductors against all claims, costs, damages, and expenses, arising out of, directly or indirectly, any claim of personal damage, injury or death associated with such unintended or unauthorized use.

Vishay Semiconductor GmbH, P.O.B. 3535, D-74025 Heilbronn, Germany
Telephone: 49 (0)7131 67 2831, Fax number: 49 (0)7131 67 2423



Notice

Specifications of the products displayed herein are subject to change without notice. Vishay Intertechnology, Inc., or anyone on its behalf, assumes no responsibility or liability for any errors or inaccuracies.

Information contained herein is intended to provide a product description only. No license, express or implied, by estoppel or otherwise, to any intellectual property rights is granted by this document. Except as provided in Vishay's terms and conditions of sale for such products, Vishay assumes no liability whatsoever, and disclaims any express or implied warranty, relating to sale and/or use of Vishay products including liability or warranties relating to fitness for a particular purpose, merchantability, or infringement of any patent, copyright, or other intellectual property right.

The products shown herein are not designed for use in medical, life-saving, or life-sustaining applications. Customers using or selling these products for use in such applications do so at their own risk and agree to fully indemnify Vishay for any damages resulting from such improper use or sale.