



**NON-BASE LEAD  
OPTICALLY COUPLED ISOLATOR  
PHOTOTRANSISTOR OUTPUT**

**APPROVALS**

- UL recognised, File No. E91231

**'X' SPECIFICATION APPROVALS**

- VDE 0884 approval pending
- EN60950 approval pending

**DESCRIPTION**

The CNX62A optically coupled isolator consists of an infrared light emitting diode and a NPN silicon photo transistor in a standard 6 pin dual in line plastic package with the base pin unconnected.

**FEATURES**

- Options :-  
10mm lead spread - add G after part no.  
Surface mount - add SM after part no.  
Tape&reel - add SMT&R after part no.
- High Current Transfer Ratio (40% min)
- Low Saturation Voltage suitable for TTL integrated circuits
- High  $BV_{CEO}$  (50V min)
- High Isolation Voltage ( $5.3kV_{RMS}$ ,  $7.5kV_{PK}$ )
- Base pin unconnected for improved noise immunity in high EMI environment

**APPLICATIONS**

- DC motor controllers
- Industrial systems controllers
- Signal transmission between systems of different potentials and impedances

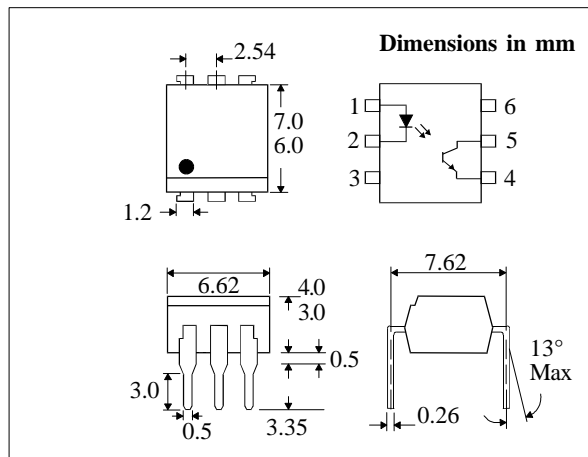
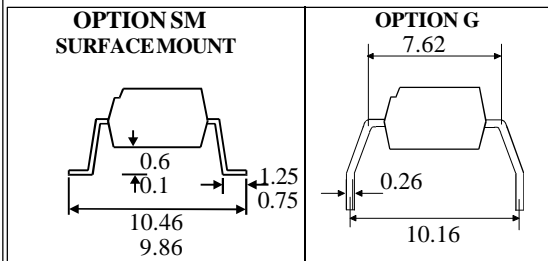

**ABSOLUTE MAXIMUM RATINGS  
(25°C unless otherwise specified)**

Storage Temperature	-55°C to + 150°C
Operating Temperature	-55°C to + 100°C
Lead Soldering Temperature (1/16 inch (1.6mm) from case for 10 secs)	260°C

**INPUT DIODE**

Forward Current	60mA
Reverse Voltage	6V
Power Dissipation	105mW

**OUTPUT TRANSISTOR**

Collector-emitter Voltage $BV_{CEO}$	50V
Emitter-collector Voltage $BV_{ECO}$	6V
Power Dissipation	160mW

**POWER DISSIPATION**

Total Power Dissipation	200mW
(derate linearly 2.67mW/°C above 25°C)	

**ISOCOM COMPONENTS LTD**  
Unit 25B, Park View Road West,  
Park View Industrial Estate, Brenda Road  
Hartlepool, Cleveland, TS25 1YD  
Tel: (01429) 863609 Fax :(01429) 863581

**ISOCOM INC**  
1024 S. Greenville Ave, Suite 240,  
Allen, TX 75002 USA  
Tel: (214)495-0755 Fax: (214)495-0901  
e-mail info@isocom.com  
http://www.isocom.com

**ELECTRICAL CHARACTERISTICS (  $T_A = 25^\circ\text{C}$  Unless otherwise noted )**

PARAMETER		MIN	TYP	MAX	UNITS	TEST CONDITION
Input	Forward Voltage ( $V_F$ )		1.2	1.5	V	$I_F = 10\text{mA}$
	Reverse Voltage ( $V_R$ )	6			V	$I_R = 10\mu\text{A}$
	Reverse Current ( $I_R$ )			10	$\mu\text{A}$	$V_R = 6\text{V}$
Output	Collector-emitter Breakdown ( $BV_{CEO}$ ) (Note 2)	50			V	$I_C = 1\text{mA}$
	Emitter-collector Breakdown ( $BV_{ECO}$ )	6			V	$I_E = 100\mu\text{A}$
	Collector-emitter Dark Current ( $I_{CEO}$ )			50	nA	$V_{CE} = 10\text{V}$
Coupled	Current Transfer Ratio ( $I_C / I_F$ ) (Note 2)	0.4	1.5			$10\text{mA } I_F, 0.4\text{V } V_{CE}$ $10\text{mA } I_F, 5\text{V } V_{CE}$
	Collector-emitter Saturation Voltage $V_{CE(SAT)}$			0.4	V	$10\text{mA } I_F, 4\text{mA } I_C$
	Input to Output Isolation Voltage $V_{ISO}$	5300 7500			$V_{RMS}$ $V_{PK}$	See note 1 See note 1
	Input-output Isolation Resistance $R_{ISO}$	$5 \times 10^{10}$			$\Omega$	$V_{IO} = 500\text{V}$ (note 1)
	Turn-on Time $t_{on}$		3		$\mu\text{s}$	$V_{CC} = 5\text{V}, I_C = 2\text{mA},$ $R_L = 100\Omega$
	Turn-off Time $t_{off}$		3		$\mu\text{s}$	
	Turn-on Time $t_{on}$		12		$\mu\text{s}$	$V_{CC} = 5\text{V}, I_C = 2\text{mA},$ $R_L = 1\text{k}\Omega$
Turn-off Time $t_{off}$		12		$\mu\text{s}$		

Note 1 Measured with input leads shorted together and output leads shorted together.

Note 2 Special Selections are available on request. Please consult the factory.

**Collector Power Dissipation vs. Ambient Temperature**

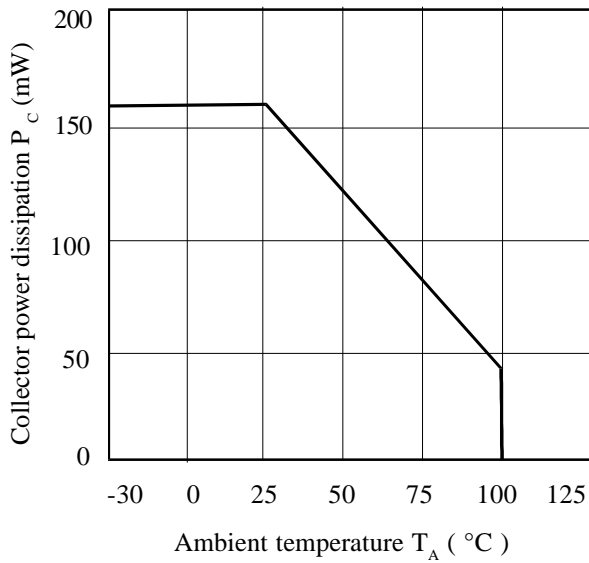

**Collector Current vs. Collector-emitter Voltage**

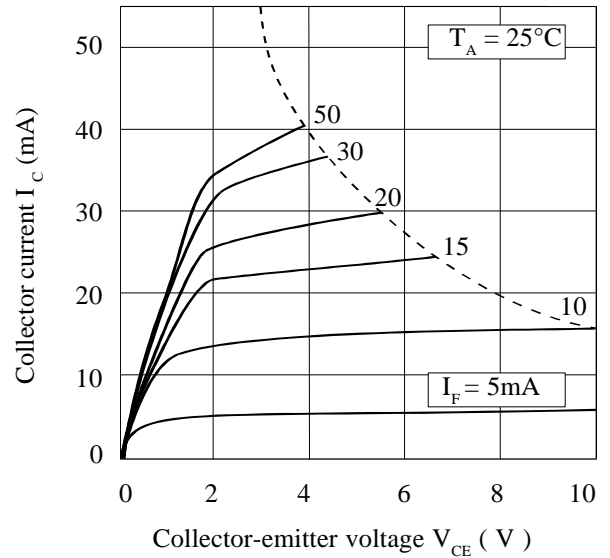

**Forward Current vs. Ambient Temperature**

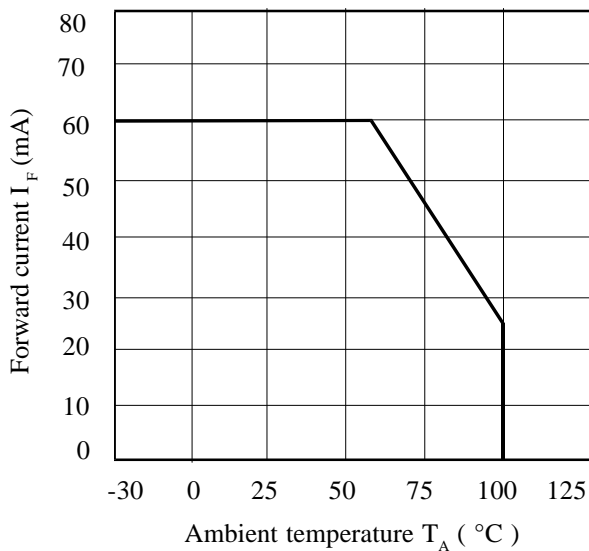

**Collector-emitter Saturation Voltage vs. Ambient Temperature**

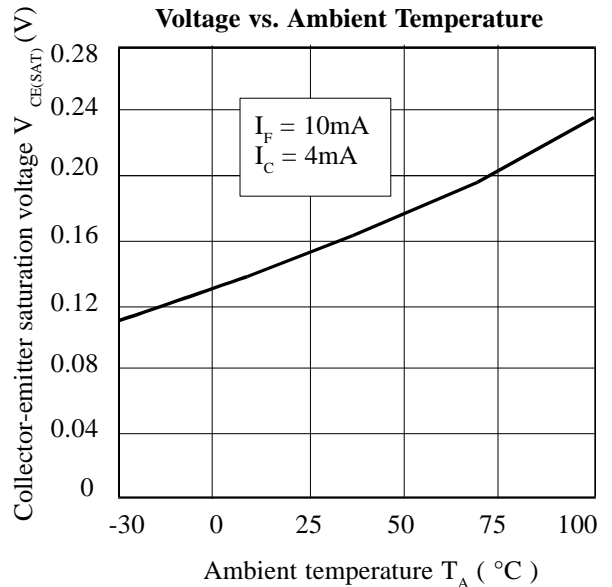

**Relative Current Transfer Ratio vs. Ambient Temperature**

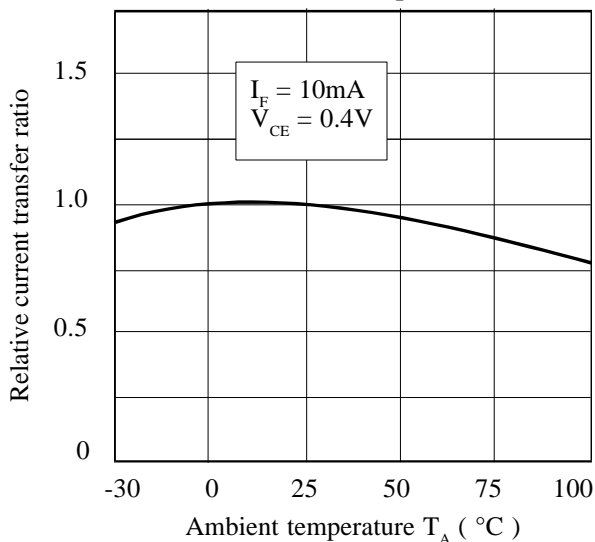

**Relative Current Transfer Ratio vs. Forward Current**

