

- **FEATURES**
- **High Current Transfer Ratio**  
CNY17F-1, 40-80%  
CNY17F-2, 63-125%  
CNY17F-3, 100-200%  
CNY17F-4, 160-320%
- **Breakdown Voltage, 5300 V<sub>RMS</sub>**
- **High Collector-Emitter Voltage**
- **V<sub>CEO</sub>=70 V**
- **No Base Terminal Connection for Improved Common Mode Interface Immunity**
- **Field-Effect Stable by TRIOS—Transparent IO Shield**
- **Long Term Stability**
- **Industry Standard Dual-in-Line Package**
- **Underwriters Lab File #E52744**
- **VDE #0884, Available with Option 1**

### Maximum Ratings T<sub>A</sub>=25°C

#### Emitter

Reverse Voltage	6.0 V
DC Forward Current	60 mA
Surge Forward Current (t ≤ 10 μs)	2.5 A
Total Power Dissipation	100 mW

#### Detector

Collector-Emitter Breakdown Voltage	70 V
Collector Current	50 mA
Collector Current (t ≤ 1.0 ms)	100 mA
Total Power Dissipation	150 mW

#### Package

Isolation Test Voltage (between emitter and detector referred to standard climate 23/50 DIN 50014)	5300 V <sub>RMS</sub>
Creepage	≥ 7.0 mm
Clearance	≥ 7.0 mm
Isolation Thickness between Emitter and Detector	≥ 0.4 mm
Comparative Tracking Index per DIN IEC 112/VDE 0303, part 1	175
Isolation Resistance (V <sub>IO</sub> =500 V)	≥ 10 <sup>11</sup> Ω
Storage Temperature Range	-55 to +150°C
Ambient Temperature Range	-55 to +100°C
Junction Temperature	100°C
Soldering Temperature (max. 10 s, dip soldering; distance to seating plane ≥ 1.5 mm)	260°C

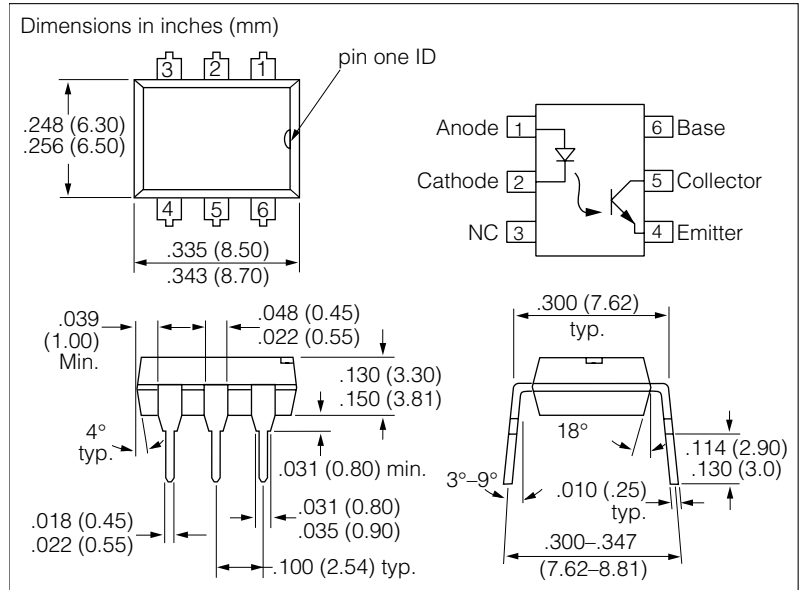

### DESCRIPTION

The CNY17F is an optocoupler consisting of a Gallium Arsenide infrared emitting diode optically coupled to a silicon planar phototransistor detector in a plastic plug-in DIP-6 package.

The coupling device is suitable for signal transmission between two electrically separated circuits. The potential difference between the circuits to be coupled is not allowed to exceed the maximum permissible reference voltages.

In contrast to the CNY17 Series, the base terminal of the F type is not connected, resulting in a substantially improved common-mode interference immunity.

### Characteristics T<sub>A</sub>=25°C

Parameter	Symbol	Value	Unit	Condition
<b>Emitter</b>				
Forward Voltage	V <sub>F</sub>	1.25 (≤1.65)	V	I <sub>F</sub> =60 mA
Breakdown Voltage	V <sub>BR</sub>	≥6.0		I <sub>R</sub> =10 μA
Reverse Current	I <sub>R</sub>	0.01 (≤10)	μA	V <sub>R</sub> =6.0 V
Capacitance	C <sub>O</sub>	25	pF	V <sub>R</sub> =0 V, f=1.0 MHz
Thermal Resistance	R <sub>thJA</sub>	750	K/W	—
<b>Detector</b>				
Capacitance	C <sub>CE</sub>	5.2	pF	V <sub>CE</sub> =5.0 V, f=1.0 MHz
	C <sub>BC</sub>	6.5		
	C <sub>EB</sub>	7.5		
Thermal Resistance	R <sub>thJA</sub>	500	K/W	—
<b>Package</b>				
Saturation Voltage, Collector-Emitter	V <sub>CEsat</sub>	0.25 (≤0.4)	V	I <sub>F</sub> =10 mA I <sub>C</sub> =2.5 mA
Coupling Capacitance	C <sub>C</sub>	0.6	pF	—

**Current Transfer Ratio  $I_C/I_F$  at  $V_{CE}=5.0$  V,  $25^\circ\text{C}$  and Collector-Emitter Leakage Current by dash number**

	-1	-2	-3	-4	Unit
$I_C/I_F$ at $V_{CE}=5.0$ V ( $I_F=10$ mA)	40-80	63-125	100-200	160-320	%
$I_C/I_F$ at $V_{CE}=5.0$ V ( $I_F=1.0$ mA)	30 (>13)	45 (>22)	70 (>34)	90 (>56)	
Collector-Emitter Leakage Current ( $V_{CE}=10$ V) ( $I_{CEO}$ )	2.0 ( $\leq 50$ )	2.0 ( $\leq 50$ )	5.0 ( $\leq 100$ )		nA

**Figure 1. Linear operation (without saturation)**

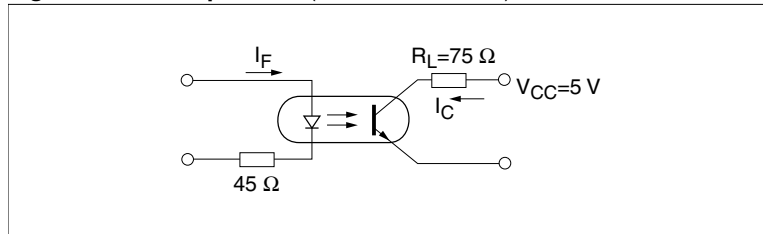

$I_F=10$  mA,  $V_{CC}=5.0$  V,  $T_A=25^\circ\text{C}$

Load Resistance	$R_L$	75	W
Turn-On Time	$t_{ON}$	3.0	$\mu\text{s}$
Rise Time	$t_r$	2.0	
Turn-Off Time	$t_{OFF}$	2.3	
Fall Time	$t_f$	2.0	
Cut-Off Frequency	$f_{CO}$	250	kHz

**Figure 2. Switching operation (with saturation)**

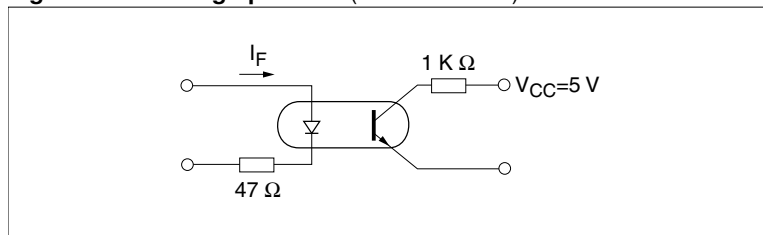

		-1 ( $I_F=20$ mA)	-2 and -3 ( $I_F=10$ mA)	-4 ( $I_F=5.0$ mA)	
Turn-On Time	$t_{ON}$	3.0	4.2	6.0	$\mu\text{s}$
Rise Time	$t_r$	2.0	3.0	4.6	
Turn-Off Time	$t_{OFF}$	18	23	25	
Fall Time	$t_f$	11	14	15	

**Figure 3. Current transfer ratio versus diode current ( $T_A=-25^\circ\text{C}$ ,  $V_{CE}=5.0$  V)  $I_C/I_F=f(I_F)$**

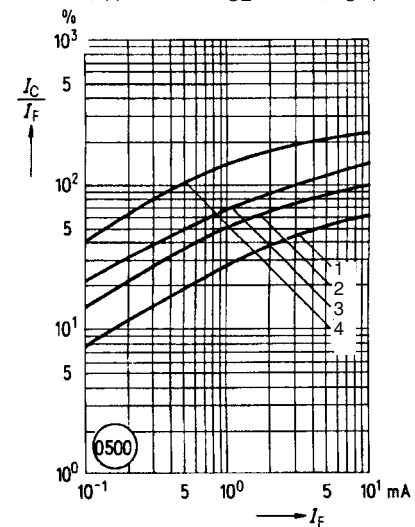

**Figure 4. Current transfer ratio versus diode current ( $T_A=0^\circ\text{C}$ ,  $V_{CE}=5.0$  V)  $I_C/I_F=f(I_F)$**

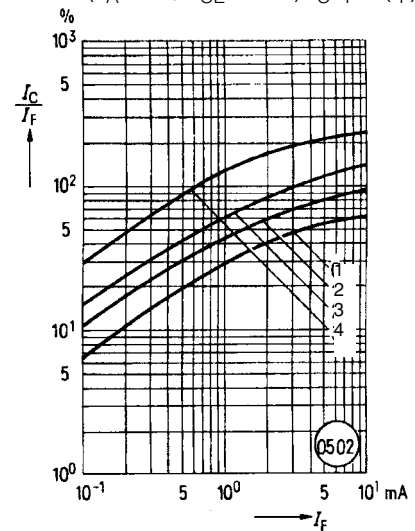

**Figure 5. Current transfer ratio versus diode current ( $T_A=25^\circ\text{C}$ ,  $V_{CE}=5.0$  V)  $I_C/I_F=f(I_F)$**

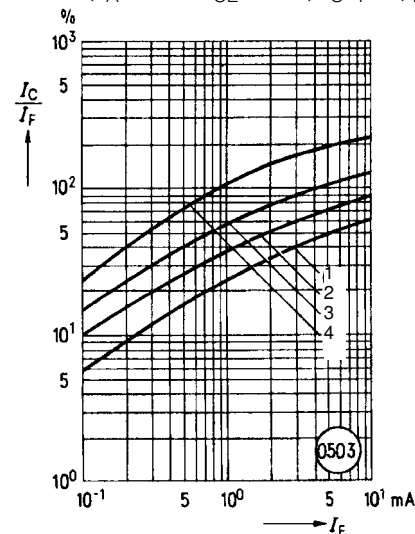

**Figure 6. Current transfer ratio versus diode current** ( $T_A=50^\circ\text{C}$ )  $V_{CE}=5.0\text{ V}$

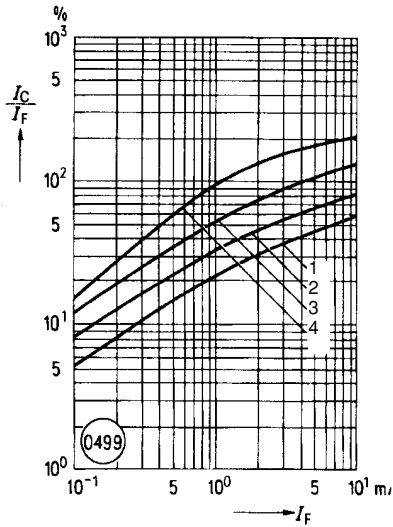

**Figure 9. Output characteristics** CNY17F-2, -3 ( $T_A=25^\circ\text{C}$ )  $I_C=f(V_{CE})$

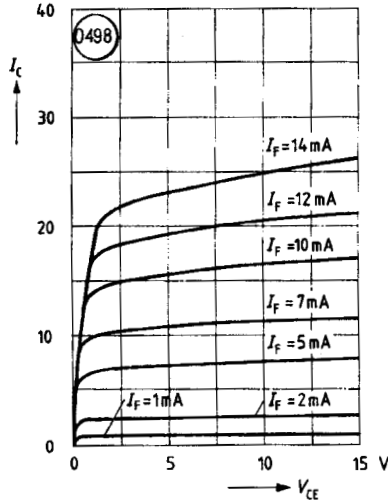

**Figure 12. Saturation voltage current and modulation** CNY17F-1

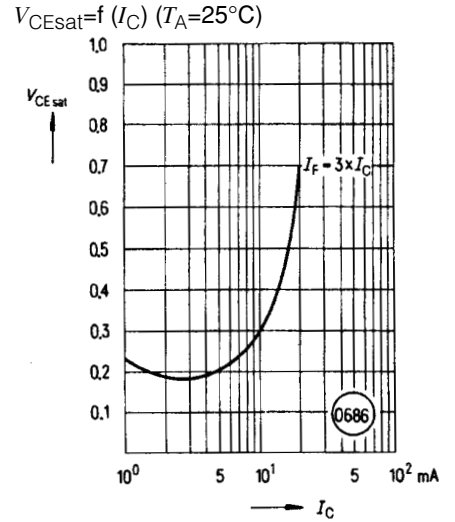

**Figure 7. Current transfer ratio versus diode current** ( $T_A=75^\circ\text{C}$ )  $V_{CE}=5.0\text{ V}$

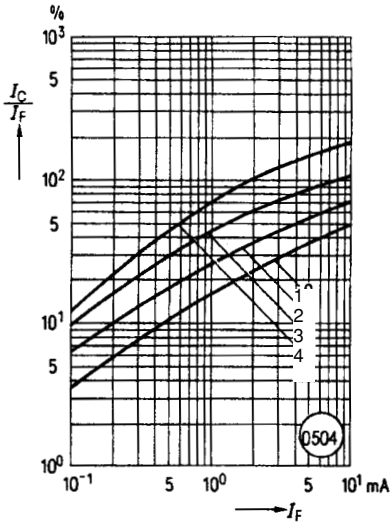

**Figure 10. Forward voltage**  $V_F=f(I_F)$

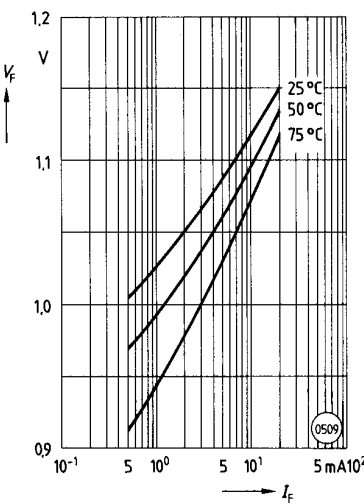

**Figure 13. Saturation voltage versus collector current and modulation depth** CNY17F-2  $V_{CEsat}=f(I_C)$  ( $T_A=25^\circ\text{C}$ )

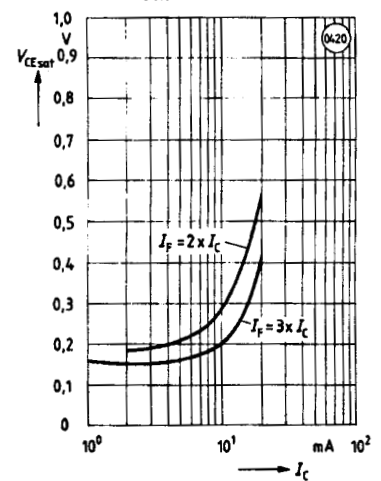

**Figure 8. Current transfer ratio versus temperature** ( $I_F=10\text{ mA}$ ,  $V_{CE}=5.0\text{ V}$ )

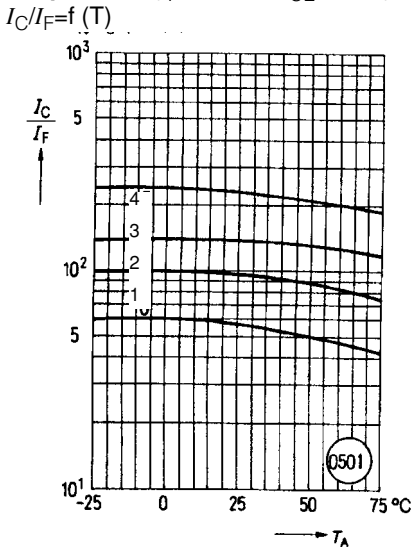

**Figure 11. Collector emitter off-state current**  $I_{CEO}=f(V,T)$  ( $T_A=75^\circ\text{C}$ ,  $I_F=0$ )

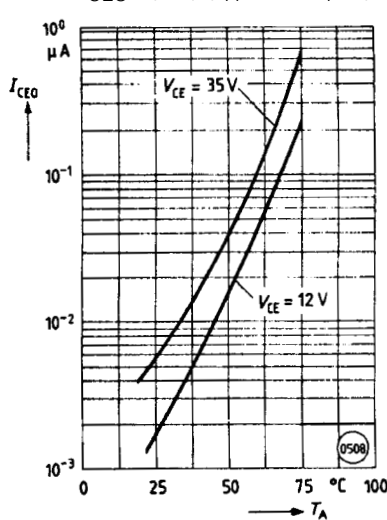

**Figure 14. Saturation voltage versus collector current and modulation depth** CNY17F-3  $V_{CEsat}=f(I_C)$  ( $T_A=25^\circ\text{C}$ )

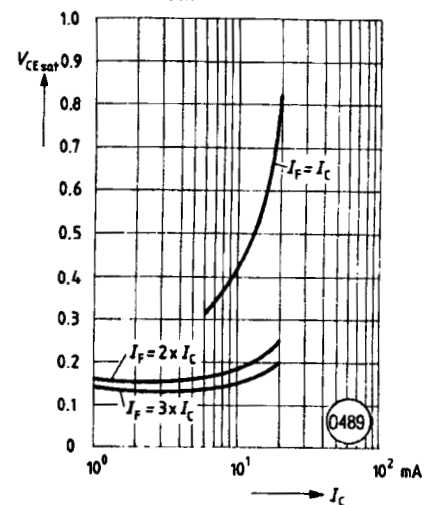

**Figure 15. Saturation voltage versus collector current and modulation depth CNY17F-4**  $V_{CEsat}=f(I_C)$  ( $T_A=25^\circ\text{C}$ )

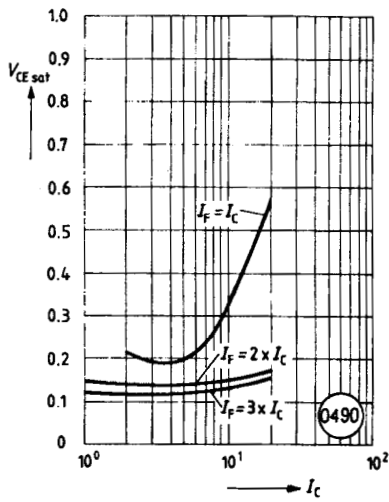

**Figure 17. Permissible power dissipation transistor and diode**  $P_{tot}=f(T_A)$

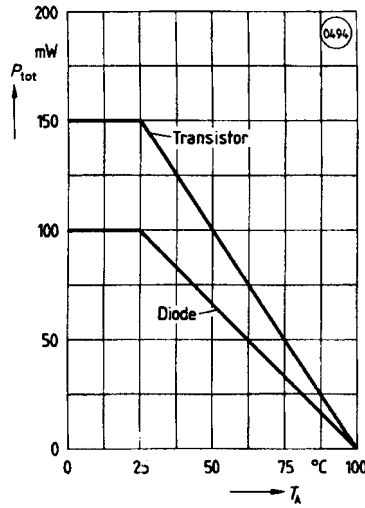

**Figure 19. Transistor capacitance**  $C=f(V_O)$  ( $T_A=25^\circ\text{C}$ ,  $f=1.0\text{ MHz}$ )

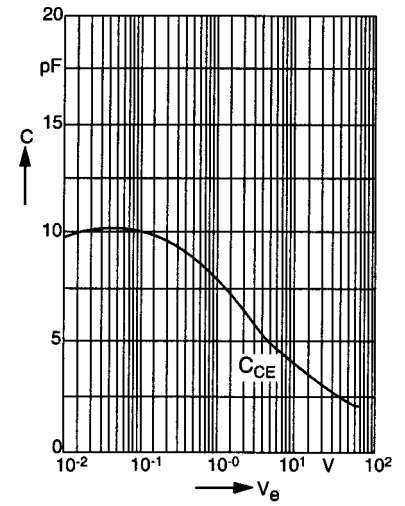

**Figure 16. Permissible pulse load**  $D=\text{parameter}$ ,  $T_A=25^\circ\text{C}$ ,  $I_F=f(t_D)$

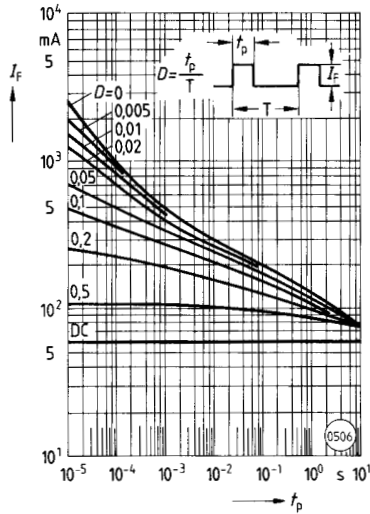

**Figure 18. Permissible forward current diode**  $I_F=f(T_A)$

