

Through-Hole or Surface Mount

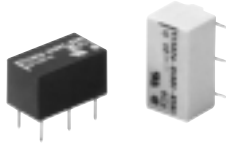

V23026 series

Miniature, Sealed PC Board Relay

File E48393

File LR45064-5

CECC approved in accordance with CECC 16501-002/VDE400.74/04.90 (Through-hole version)

Features

- Surface and through-hole mounting types.
- 1 Form C contact arrangement.
- Latching or non-latching versions available.
- Switches loads from dry circuit to 1 amp.
- Washable – meets IEC protection class IP67.
- Low coil power requirement for IC compatibility.
- Terminals arranged on 0.1" grid.
- Designed for compact, high density mounting, 106.6mm² surface area.
- Getter protected contact area.
- Ideal for data and communication systems.

Contact Data @ 25°C

Arrangements: 1 Form C (SPDT).

Material & Style: Palladium-Nickel with Gold-Rhodium overlay, bifurcated.

Expected Mechanical Life: 1 billion operations.

Expected Electrical Life: 50 million ops. at 100mA, 6VDC, res., 10 ops./sec.;
 3 million ops. at 1A, 24VDC, res., 6 ops./min.;
 500,000 ops. at 500mA, 100VDC, res., 6 ops./min.;
 250,000 ops. at 400mA, 125VAC, res., 6 ops./min.

Contact Ratings:

Maximum Switched Voltage: 150VDC, 125VAC.

Maximum Switched Current: 1A.

Maximum Carrying Current: 1A.

Maximum Switched Power: 30W (DC), 60VA (AC).

Note: Max. switched power is voltage dependent. See Figure 1.

Minimum Switched Capability: 100µV.

Initial Contact Resistance: 50 milliohms max. @ 10mA, 6VDC.

Figure 1 – Limiting Curve for Contact Loads

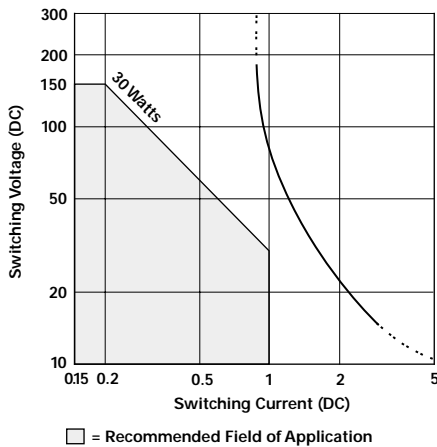

Initial Dielectric Strength

Between Open Contacts: 500V rms.

Note: FCC version meets 1,500V surge per FCC Part 68. Consult factory regarding availability (10/160µs).

Between Contacts and Coil: 1,500V rms.

Initial Insulation Resistance

Between Mutually Insulated Conductors: 10⁹ ohms @ 500VDC.

Coil Data @ 20°C

Voltage: 1.5 to 24VDC.

Thermal Resistance at Continuous Thermal Load: 130°K per Watt.

Maximum Coil Temperature: 85°C.

Duty Cycle: Continuous.

Coil Data @ 20°C

Nominal Voltage (VDC)	Maximum Operating Voltage (VDC)	Nominal Power (mW)	Resistance (Ohms) ± 10%	Coil Number Order Designation (Step 4 in Ordering Information chart)
Non-Latching — Through-Hole versions (A1)				
1.5	4.5	63	36	7
3	8.8	66	137	6
5	14.5	67	370	1
9	25.5	69	1,165	5
12	35	64	2,250	2
15	42	72	3,100	3
24	50	128	4,500	4
Non-Latching — Surface-Mount versions (D1)				
1.5	4	80	28	7
3	8	80	113	6
5	13.3	80	313	1
9	24	80	1,013	5
12	32	80	1,800	2
15	40	80	2,813	3
24	50	128	4,500	4
Bistable, Dual Coils — Through-Hole and Surface-Mount versions (B1,E1) (values are the same for each coil)⁽¹⁾				
1.5	4.25	70	32	7
3	8.55	69	130	6
5	14.75	64	390	1
9	14.75	68	1,200	5
12	29	96	1,500	2
15	29	150	1,500	3
Bistable, Single Coil — Through-Hole and Surface-Mount versions (C1,F1)				
1.5	6	37	61	5
3	13	30	300	6
5	20	34	740	1
9	35	38	2,160	7
12	50	32	4,500	2
15	50	50	4,500	3
24	50	128	4,500	4

(1) The specified voltages apply with only one coil energized.

Operate Data @ 20°C

Must Operate Voltage: 75% of nominal voltage or less.

Must Release Voltage: 10% of nominal voltage or less.

Max. Continuous Thermal Load : 500mW.

Operate Time (Excluding Bounce)t: 1 ms, typ.

Operate Bounce Time†: 1 ms, typ.

Release Time (Excluding Bounce)t: 0.4 ms, typ.

Set Time (Latching)t: 1 ms, typ.

Reset Time (Latching)t: 0.9 ms, typ.

Maximum Switching Rate: 200 operations/second.

† At or from Nominal Coil Voltage

Environmental Data

Temperature Range: -40°C to +70°C.

Vibration, Operational: 40g, 10-200 Hz.

Shock, Operational: 50g at 11 ms 1/2 sinusoidal impulse.

Surface Mount Version Only:

Vapor Phase: 215°C, 40 sec.

Infrared: 215°C, 40 sec.

Double Wave: 260°C, 10 sec.

Mechanical Data

Termination: Through-hole or surface mount printed circuit terminals.

Enclosure Type: Immersion cleanable, plastic sealed case.

Weight: 0.063 oz. (1.8g) approximately.

Ordering Information

Typical Part Number ► **V23026**

A1

00

2

B201

1. Basic Series:

V23026 = Miniature, printed circuit board relay.

2. Termination:

	Non-Latching	Dual Coil Latching	Single Coil Latching
Through-Hole	A1	B1	C1
Surface Mount	D1	E1	F1

Consult factory regarding availability of models meeting FCC Part 68/1500V surge requirement.

3. Function Type:

00 = Single Coil Non-Latching, Through-Hole terminals 02 = Single Coil Non-Latching, Surface-Mount terminals
 05 = Single Coil Latching 10 = Dual Coil Latching

4. Coil Voltage:

7 = 1.5VDC⁽¹⁾ 6 = 3VDC 1 = 5VDC 5 = 9VDC⁽¹⁾ 2 = 12VDC 3 = 15VDC 4 = 24VDC⁽²⁾

(1) For single coil latching versions only (C1, F1), 5 = 1.5VDC and 7 = 9VDC (2) 24V coil not available on dual coil version

5. Contact Type:

B201 = Bifurcated, 1 Form C (SPDT).

*Consult factory for tape and reel packaging.

Stock Items – Recommended part numbers are for new designs.

V23026A1001B201 V23026D1021B201
 V23026A1002B201 V23026D1022B201
 V23026A1004B201 V23026D1024B201

Outline Dimensions

Through-Hole

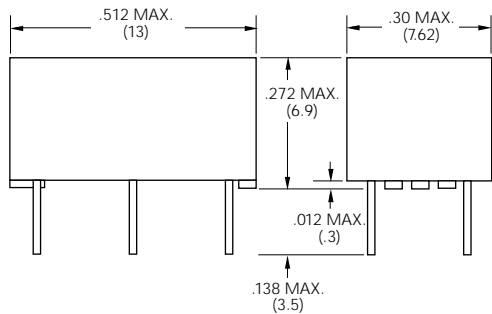

Surface Mount

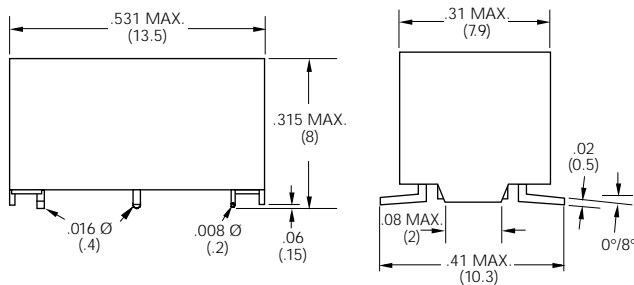

Wiring Diagrams (Bottom Views)

Single Coil Non-Latching & Single Coil Latching

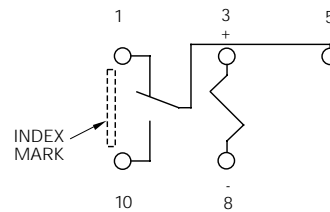

For non-latching versions, coil polarity must be observed.
 For single coil latching versions, polarity shown results in "set" condition.
 Reverse polarity results in "reset" condition.
 Diagram indicates de-energized position for non-latching and "reset" position for single coil latching.

Dual Coil Latching

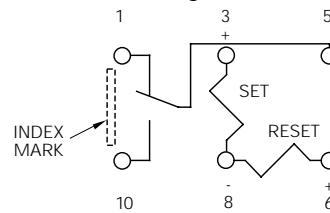
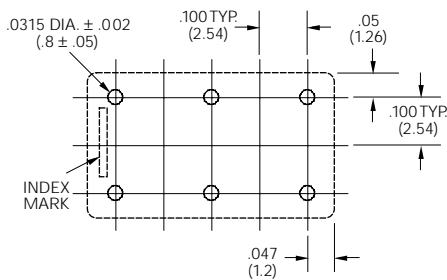

Diagram indicates relay in the "reset" position, with "reset" coil most recently energized as shown. Energizing "set" coil as shown will transfer the contacts.

PC Board Layouts (Bottom Views)

Through-Hole



Surface Mount

