

FEATURES

Complete, Low Cost Stereo DAC System in a Single Die Package

Variable Rate Oversampling Interpolation Filter
Multibit $\Sigma\Delta$ Modulator with Triangular PDF Dither
Discrete and Continuous Time Analog Reconstruction Filters

Extremely Low Out-of-Band Energy

64 Step (1 dB/Step) Analog Attenuator with Mute
Buffered Outputs with 2 k Ω Output Load Drive
Rejects Sample Clock Jitter

94 dB Dynamic Range, -88 dB THD+N Performance
Option for Analog De-emphasis Processing with
External Passive Components

$\pm 0.1^\circ$ Maximum Phase Linearity Deviation
Continuously Variable Sample Rate Support

Digital Phase Locked Loop Based Asynchronous Master
Clock

On-Chip Master Clock Oscillator, Only External Crystal
Is Required

Power-Down Mode

Flexible Serial Data Port (I²S-Justified, Left-Justified,
Right-Justified and DSP Serial Port Modes)

SPI* Compatible Serial Control Port

Single +5 V Supply

28-Pin SOIC and SSOP Packages

APPLICATIONS

Digital Cable TV and Direct Broadcast Satellite Set-Top
Decoder Boxes

Digital Video Disc, Video CD and CD-I Players

High Definition Televisions, Digital Audio Broadcast
Receivers

CD, CD-R, DAT, DCC, ATAPI CD-ROM and MD Players

Digital Audio Workstations, Computer Multimedia
Products

PRODUCT OVERVIEW

The AD1859 is a complete 16-/18-bit single-chip stereo digital audio playback subsystem. It comprises a variable rate digital interpolation filter, a revolutionary multibit sigma-delta ($\Sigma\Delta$) modulator with dither, a jitter-tolerant DAC, switched capacitor and continuous time analog filters, and analog output drive circuitry. Other features include an on-chip stereo attenuator and mute, programmed through an SPI-compatible serial control port.

The key differentiating feature of the AD1859 is its asynchronous master clock capability. Previous $\Sigma\Delta$ audio DACs required a high frequency master clock at 256 or 384 times the intended audio sample rate. The generation and management of this high frequency synchronous clock is burdensome to the board level designer. The analog performance of conventional single bit $\Sigma\Delta$ DACs is also dependent on the spectral purity of the sample and master clocks. The AD1859 has a digital Phase Locked Loop (PLL) which allows the master clock to be asynchronous, and which also strongly rejects jitter on the sample clock (left/right clock). The digital PLL allows the AD1859 to be clocked with a single frequency (27 MHz for example) while the sample frequency (as determined from the left/right clock) can vary over a wide range. The digital PLL will lock to the new sample rate in approximately 100 ms. Jitter components 15 Hz above and below the sample frequency are rejected by 6 dB per octave. This level of jitter rejection is unprecedented in audio DACs.

The AD1859 supports continuously variable sample rates with essentially linear phase response, and with an option for external analog de-emphasis processing. The clock circuit includes an on-chip oscillator, so that the user need only provide an external crystal. The oscillator may be overdriven, if desired, with an external clock source.

(continued on page 7)

FUNCTIONAL BLOCK DIAGRAM

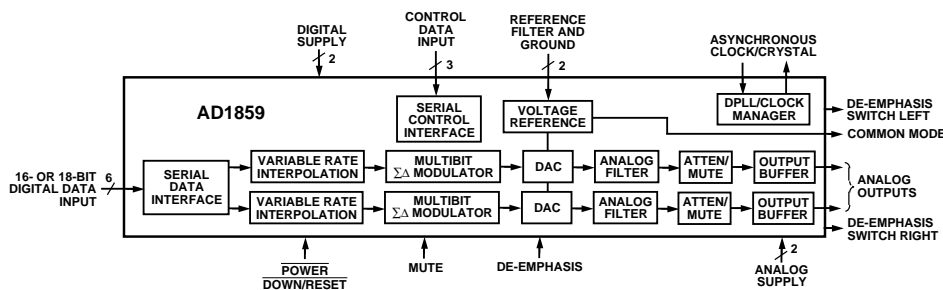

*SPI is a registered trademark of Motorola, Inc.

REV. A

Information furnished by Analog Devices is believed to be accurate and reliable. However, no responsibility is assumed by Analog Devices for its use, nor for any infringements of patents or other rights of third parties which may result from its use. No license is granted by implication or otherwise under any patent or patent rights of Analog Devices.

© Analog Devices, Inc., 1996

One Technology Way, P.O. Box 9106, Norwood, MA 02062-9106, U.S.A.
Tel: 617/329-4700 Fax: 617/326-8703

AD1859–SPECIFICATIONS

TEST CONDITIONS UNLESS OTHERWISE NOTED

Supply Voltages (AV _{DD} , DV _{DD})	+5.0	V
Ambient Temperature	25	°C
Input Clock (F _{MCLK})	27.1656	MHz
Input Signal	1001.2938	Hz
	-0.5	dB Full Scale
Input Sample Rate	44.1	kHz
Measurement Bandwidth	10 Hz to 20 kHz	
Input Data Word Width	18	Bits
Load Capacitance	100	pF
Input Voltage HI (V _{IH})	2.4	V
Input Voltage LO (V _{IL})	0.8	V

NOTES

I²S-Justified Mode (Ref. Figure 3).

Device Under Test (DUT) is bypassed, decoupled and dc-coupled as shown in Figure 17 (no de-emphasis circuit).

Performance of the right and left channels are identical (exclusive of “Interchannel Gain Mismatch” and “Interchannel Phase Deviation” specifications).

Attenuation setting is 0 dB.

Values in bold typeface are tested; all others are guaranteed, not tested.

ANALOG PERFORMANCE

	Min	Typ	Max	Units
Resolution		18		Bits
Dynamic Range (20 to 20 kHz, -60 dB Input)				
(No A-Weight Filter)	85.7	91		dB
(With A-Weight Filter)	88	94		dB
Total Harmonic Distortion + Noise		-88	-84	dB
		0.004	0.0063	%
Analog Outputs				
Single-Ended Output Range (±Full Scale)	2.8	3.0	3.2	V p-p
Output Impedance at Each Output Pin		17	24	Ω
Output Capacitance at Each Output Pin			20	pF
External Load Impedance (THD +N ≤ -84 dB)	750	2K		Ω
Out-of-Band Energy (0.5 × F _S to 100 kHz)			-72.5	dB
CMOUT	2.05	2.25	2.45	V
DC Accuracy				
Gain Error		±1	±5	%
Interchannel Gain Mismatch		0.01	0.225	dB
Gain Drift		140	270	ppm/°C
Interchannel Crosstalk (EIAJ Method)	101			dB
Interchannel Phase Deviation		±0.1		Degrees
Attenuator Step Size	0.6	1.0	1.4	dB
Attenuator Range Span	-61.5	-62.5	-63.5	dB
Mute Attenuation	-70	-74.2		dB
De-Emphasis Switch (EMPL, EMPR) DC Resistance	3	10	50	Ω

DIGITAL INPUTS

	Min	Typ	Max	Units
Input Voltage HI (V _{IH})	2.4			V
Input Voltage LO (V _{IL})			0.8	V
Input Leakage (I _{IH} @ V _{IH} = 2.4 V)		1	6	μA
Input Leakage (I _{IL} @ V _{IL} = 0.8 V)		1	6	μA
Input Capacitance			20	pF

DIGITAL TIMING (Guaranteed over -40°C to $+105^{\circ}\text{C}$, $\text{AV}_{\text{DD}} = \text{DV}_{\text{DD}} = +5.0\text{ V} \pm 10\%$)

		Min	Typ	Max	Units
t_{DBH}	BCLK HI Pulse Width	25			ns
t_{DBL}	BCLK LO Pulse Width	25			ns
t_{DBP}	BCLK Period	50			ns
t_{DLS}	$\overline{\text{LRCLK}}$ Setup	5			ns
t_{DLH}	$\overline{\text{LRCLK}}$ Hold (DSP Serial Port Style Mode Only)	0			ns
t_{DDS}	SDATA Setup	0			ns
t_{DDH}	SDATA Hold	5			ns
t_{CCH}	CCLK HI Pulse Width	15			ns
t_{CCL}	CCLK LO Pulse Width	15			ns
t_{CCP}	CCLK Period	30			ns
t_{CSU}	CDATA Setup	0			ns
t_{CHD}	CDATA Hold	5			ns
t_{CLD}	CLATCH Delay	15			ns
t_{CLL}	CLATCH LO Pulse Width	5			ns
t_{CLH}	CLATCH HI Pulse Width	10			ns
t_{PDRP}	$\overline{\text{PD/RST}}$ LO Pulse Width	4 MCLK Periods ($\approx 150\text{ ns}$ @ 27 MHz)			
t_{MCP}	MCLK Period	30	37	60	ns
F_{MC}	MCLK Frequency ($1/t_{\text{MCP}}$)	17	27	33	MHz
t_{MCH}	MCLK HI Pulse Width	15			ns
t_{MCL}	MCLK LO Pulse Width	15			ns

POWER

	Min	Typ	Max	Units
Supplies				
Voltage, Analog and Digital	4.5	5	5.5	V
Analog Current	29.5	36	mA	
Analog Current—Power Down		0.5	15	μA
Digital Current	23.5	30	mA	
Digital Current—Power Down		6	9.5	mA
Dissipation				
Operation—Both Supplies		265	330	mW
Operation—Analog Supply		147.5	180	mW
Operation—Digital Supply		117.5	150	mW
Power Down—Both Supplies		30	48	mW
Power Supply Rejection Ratio				
1 kHz 300 mV p-p Signal at Analog Supply Pins		55		dB
20 kHz 300 mV p-p Signal at Analog Supply Pins		52		dB

TEMPERATURE RANGE

	Min	Typ	Max	Units
Specifications Guaranteed		25		$^{\circ}\text{C}$
Functionality Guaranteed	-40		+105	$^{\circ}\text{C}$
Storage	-55		+125	$^{\circ}\text{C}$

PACKAGE CHARACTERISTICS

	Typ	Units
SOIC θ_{JA} (Thermal Resistance [Junction-to-Ambient])	120.67	$^{\circ}\text{C}/\text{W}$
SOIC θ_{JC} (Thermal Resistance [Junction-to-Case])	13.29	$^{\circ}\text{C}/\text{W}$
SSOP θ_{JA} (Thermal Resistance [Junction-to-Ambient])	190.87	$^{\circ}\text{C}/\text{W}$
SSOP θ_{JC} (Thermal Resistance [Junction-to-Case])	15.52	$^{\circ}\text{C}/\text{W}$

AD1859

ABSOLUTE MAXIMUM RATINGS*

	Min	Typ	Max	Units
DV _{DD} to DGND	-0.3		6	V
AV _{DD} to AGND	-0.3		6	V
Digital Inputs	DGND - 0.3		DV _{DD} + 0.3	V
Analog Inputs	AGND - 0.3		AV _{DD} + 0.3	V
AGND to DGND	-0.3		0.3	V
Reference Voltage	Indefinite Short Circuit to Ground			°C
Soldering			+300	sec
			10	

*Stresses greater than those listed under “Absolute Maximum Ratings” may cause permanent damage to the device. This is a stress rating only and functional operation of the device at these or any other conditions above those indicated in the operational section of this specification is not implied. Exposure to absolute maximum rating conditions for extended periods may affect device reliability.

DIGITAL FILTER CHARACTERISTICS

	Min	Typ	Max	Units
Passband Ripple			±0.045	dB
Stopband ¹ Attenuation	62			dB
48 kHz F _S				
Passband	0		21.312	kHz
Stopband	26.688		6117	kHz
44.1 kHz F _S				
Passband	0		19.580	kHz
Stopband	24.520		5620	kHz
32 kHz F _S				
Passband	0		14.208	kHz
Stopband	17.792		4078	kHz
Other F _S				
Passband	0		0.444	F _S
Stopband	0.556		127.444	F _S
Group Delay			40/F _S	sec
Group Delay Variation			0	µs

ANALOG FILTER CHARACTERISTICS

	Min	Typ	Max	Units
Passband Ripple			-0.075	dB
Stopband Attenuation (at 64 × F _S)	58			dB

NOTE

¹Stopband nominally repeats itself at multiples of 128 × F_S, where F_S is the input word rate. Thus the digital filter will attenuate to 62 dB across the frequency spectrum except for a range ±0.55 × F_S wide at multiples of 128 × F_S.

ORDERING GUIDE

Model	Temperature Range	Package Description	Package Option
AD1859JR	-40°C to +105°C	28-Lead SOIC	R-28
AD1859JRS	-40°C to +105°C	28-Lead SSOP	RS-28

PIN CONNECTIONS

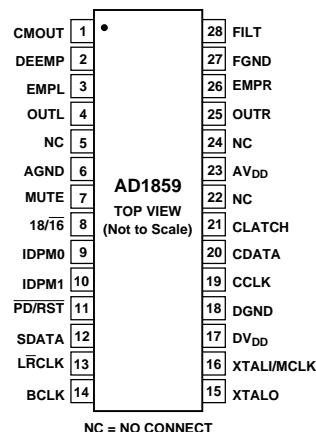

CAUTION

ESD (electrostatic discharge) sensitive device. Electrostatic charges as high as 4000 V readily accumulate on the human body and test equipment and can discharge without detection. Although the AD1859 features proprietary ESD protection circuitry, permanent damage may occur on devices subjected to high energy electrostatic discharges. Therefore, proper ESD precautions are recommended to avoid performance degradation or loss of functionality.



DEFINITIONS**Dynamic Range**

The ratio of a full-scale output signal to the integrated output noise in the passband (0 to 20 kHz), expressed in decibels (dB). Dynamic range is measured with a -60 dB input signal and is equal to $(S/[THD+N]) + 60$ dB. Note that spurious harmonics are below the noise with a -60 dB input, so the noise level establishes the dynamic range. This measurement technique is consistent with the recommendations of the Audio Engineering Society (AES17-1991) and the Electronics Industries Association of Japan (EIAJ CP-307).

Total Harmonic Distortion + Noise (THD+N)

The ratio of the root-mean-square (rms) value of a full-scale fundamental input signal to the rms sum of all other spectral components in the passband, expressed in decibels (dB) and percentage.

Passband

The region of the frequency spectrum unaffected by the attenuation of the digital interpolation filter.

Passband Ripple

The peak-to-peak variation in amplitude response from equal-amplitude input signal frequencies within the passband, expressed in decibels.

Stopband

The region of the frequency spectrum attenuated by the digital interpolation filter to the degree specified by "stopband attenuation."

Gain Error

With a near full-scale input, the ratio of actual output to expected output, expressed as a percentage.

Interchannel Gain Mismatch

With identical near full-scale inputs, the ratio of outputs of the two stereo channels, expressed in decibels.

Gain Drift

Change in response to a near full-scale input with a change in temperature, expressed as parts-per-million (ppm) per °C.

Crosstalk (EIAJ method)

Ratio of response on one channel with a zero input to a full-scale 1 kHz sine-wave input on the other channel, expressed in decibels.

Interchannel Phase Deviation

Difference in output sampling times between stereo channels, expressed as a phase difference in degrees between 1 kHz inputs.

Power Supply Rejection

With zero input, signal present at the output when a 300 mV p-p signal is applied to power supply pins, expressed in decibels of full scale.

Group Delay

Intuitively, the time interval required for an input pulse to appear at the converter's output, expressed in seconds (s). More precisely, the derivative of radian phase with respect to radian frequency at a given frequency.

Group Delay Variation

The difference in group delays at different input frequencies. Specified as the difference between the largest and the smallest group delays in the passband, expressed in microseconds (μ s).

PIN DESCRIPTIONS**Digital Audio Serial Input Interface**

Pin Name	Number	I/O	Description
SDATA	12	I	Serial input, MSB first, containing two channels of 16 or 18 bits of twos complement data per channel.
BCLK	14	I	Bit clock input for input data. Need not run continuously; may be gated or used in a burst fashion.
L \overline RCLK	13	I	Left/right clock input for input data. Must run continuously.
IDPM0	9	I	Input serial data port mode control zero. With IDPM1, defines one of four serial input modes.
IDPM1	10	I	Input serial data port mode control one. With IDPM0, defines one of four serial input modes.
18/16	8	I	18-bit or 16-bit input data mode control. Connect this signal HI for 18-bit input mode, LO for 16-bit input mode.

Serial Control Port Interface

Pin Name	Number	I/O	Description
CDATA	20	I	Serial control input, MSB first, containing 8 bits of unsigned data per channel. Used for specifying channel specific attenuation and mute.
CCLK	19	I	Control clock input for control data. Control input data must be valid on the rising edge of CCLK. CCLK may be continuous or gated.
CLATCH	21	I	Latch input for control data. This input is rising edge sensitive.

PIN DESCRIPTIONS

Analog Signals

Pin Name	Number	I/O	Description
FILT	28	O	Voltage reference filter capacitor connection. Bypass and decouple the voltage reference with parallel 10 μ F and 0.1 μ F capacitors to the FGND pin.
FGND	27	I	Voltage reference filter ground. Use exclusively for bypassing and decoupling of the FILT pin (voltage reference).
CMOUT	1	O	Voltage reference common-mode output. Should be decoupled with 10 μ F capacitor to the AGND pin or plane. This output is available externally for dc-coupling and level-shifting. CMOUT should not have any signal dependent load, or where it will sink or source current.
OUTL	4	O	Left channel line level analog output.
OUTR	25	O	Right channel line level analog output.
EMPL	3	O	De-emphasis switch connection for the left channel. Can be left unconnected if de-emphasis is not required in the target application.
EMPR	26	O	De-emphasis switch connection for the right channel. Can be left unconnected if de-emphasis is not required in the target application.

Control and Clock Signals

Pin Name	Number	I/O	Description
$\overline{\text{PD/RST}}$	11	I	Power down/reset. The AD1859 is placed in a low power consumption "sleep" mode when this pin is held LO. The AD1859 is reset on the rising edge of this signal. The serial control port registers are reset to their default values. Connect HI for normal operation.
DEEMP	2	I	De-emphasis. An external analog de-emphasis circuit network is enabled when this input signal is HI. This circuit is typically used to impose a 50/15 μ s (or perhaps the CCITT J.17) response characteristic on the output audio spectrum.
MUTE	7	I	Mute. Assert HI to mute both stereo analog outputs of the AD1859. Deassert LO for normal operation.
XTALI/ MCLK	16	I	Crystal input or master clock input. Connect to one side of a quartz crystal to this input, or connect to an external clock source to overdrive the on-chip oscillator.
XTALO	15	O	Crystal output. Connect to other side of a quartz crystal. Do not connect if using the XTALI/MCLK pin with an external clock source.

Power Supply Connections and Miscellaneous

Pin Name	Number	I/O	Description
AV _{DD}	23	I	Analog Power Supply. Connect to analog +5 V supply.
AGND	6	I	Analog Ground.
DV _{DD}	17	I	Digital Power Supply. Connect to digital +5 V supply.
DGND	18	I	Digital Ground.
NC	5, 22, 24		No Connect. Reserved. Do not connect.

(continued from page 1)

The AD1859 has a simple but very flexible serial data input port that allows for glueless interconnection to a variety of ADCs, DSP chips, AES/EBU receivers and sample rate converters. The serial data input port can be configured in left-justified, I²S-justified, right-justified and DSP serial port compatible modes. The AD1859 accepts 16- or 18-bit serial audio data in MSB-first, twos-complement format. A power-down mode is offered to minimize power consumption when the device is inactive. The AD1859 operates from a single +5 V power supply. It is fabricated on a single monolithic integrated circuit using a 0.6 μ m CMOS double polysilicon, double metal process, and is housed in 28-pin SOIC and SSOP packages for operation over the temperature range -40°C to $+105^{\circ}\text{C}$.

THEORY OF OPERATION

The AD1859 offers the advantages of sigma-delta conversion architectures (no component trims, low cost CMOS process technology, superb low level linearity performance) with the advantages of conventional multibit R-2R resistive ladder audio DACs (no requirement for any high frequency synchronous master clocks [e.g., 256 or $384 \times F_s$] continuously variable sample rate support, jitter tolerance, low output noise, etc.).

The use of a multibit sigma-delta modulator means that the AD1859 generates dramatically lower amounts of out-of-band noise energy, which greatly reduces the requirement on post DAC filtering. The required post-filtering is integrated on the AD1859. The AD1859's multibit sigma-delta modulator is also highly immune to digital substrate noise.

The digital phase locked loop feature gives the AD1859 an unprecedented jitter rejection feature. The bandwidth of the first order loop filter is 15 Hz; jitter components on the input left/right clock are attenuated by 6 dB per octave above and below 15 Hz. Jitter on the crystal time base or MCLK input is rejected as well (by virtue of the on-chip switched capacitor filter), but this clock should be low jitter because it is used by the DAC to convert the audio from the discrete time (sampled) domain to the continuous time (analog) domain. The AD1859 includes an on-chip oscillator, so that the user need only provide an inexpensive quartz crystal or ceramic resonator as an external time base.

Serial Audio Data Interface

The serial audio data interface uses the bit clock (BCLK) simply to clock the data into the AD1859. The bit clock may, therefore, be asynchronous to the L/R clock. The left/right clock (LRCLK) is both a framing signal, and the sample frequency input to the digital phase locked loop. The left/right clock (LRCLK) is the signal that the AD1859 actually uses to determine the input sample rate, and it is the jitter on LRCLK that is rejected by the digital phase locked loop. The SDATA input carries the serial stereo digital audio in MSB first, twos-complement format.

Digital Interpolation Filter

The purpose of the interpolator is to "oversample" the input data, i.e., to increase the sample rate so that the attenuation requirements on the analog reconstruction filter are relaxed. The AD1859 interpolator increases the input data sample rate by a variable factor depending on the sample frequency of the incoming digital audio. The interpolation is performed using a multi-stage FIR digital filter structure. The first stage is a droop equalizer; the second and third stages are half-band filters; and

the fourth stage is a second-order comb filter. The FIR filter implementation is multiplier-free, i.e., the multiplies are performed using shift-and-add operations.

Multibit Sigma-Delta Modulator

The AD1859 employs a four-bit sigma-delta modulator. Whereas a traditional single bit sigma-delta modulator has two levels of quantization, the AD1859's has 17 levels of quantization. Traditional single bit sigma-delta modulators sample the input signal at 64 times the input sample rate; the AD1859 samples the input signal at nominally 128 times the input sample rate. The additional quantization levels combined with the higher oversampling ratio means that the AD1859 DAC output spectrum contains dramatically lower levels of out-of-band noise energy, which is a major stumbling block with more traditional single bit sigma-delta architectures. This means that the post-DAC analog reconstruction filter has reduced transition band steepness and attenuation requirements, which equates directly to lower phase distortion. Since the analog filtering generally establishes the noise and distortion characteristic of the DAC, the reduced requirements translate into better audio performance.

Multibit sigma-delta modulators bring an additional benefit: they are essentially free of stability (and therefore potential loop oscillation) problems. They are able to use a wider range of the voltage reference, which can increase the overall dynamic range of the converter.

The conventional problem which limits the performance of multibit sigma delta converters is the nonlinearity of the passive circuit elements used to sum the quantization levels. Analog Devices has developed (and been granted patents on) a revolutionary architecture which overcomes the component linearity problem that otherwise limits the performance of multibit sigma delta audio converters. This new architecture provides the AD1859 with the same excellent differential nonlinearity and linearity drift (over temperature and time) specifications as single bit sigma-delta DACs.

The AD1859's multibit modulator has another important advantage; it has a high immunity to substrate digital noise. Substrate noise can be a significant problem in mixed-signal designs, where it can produce intermodulation products that fold down into the audio band. The AD1859 is approximately eight times less sensitive to digital substrate noise (voltage reference noise injection) than equivalent single bit sigma-delta modulator based DACs.

Dither Generator

The AD1859 includes an on-chip dither generator, which is intended to further reduce the quantization noise introduced by the multibit DAC. The dither has a triangular Probability Distribution Function (PDF) characteristic, which is generally considered to create the most favorable noise shaping of the residual quantization noise. The AD1859 is among the first low cost, IC audio DACs to include dithering.

Analog Filtering

The AD1859 includes a second-order switched capacitor discrete time low-pass filter followed by a first-order analog continuous time low-pass filter. These filters eliminate the need for any additional off-chip external reconstruction filtering. This on-chip switched capacitor analog filtering is essential to reduce the deleterious effects of any remaining master clock jitter.

AD1859

Option for Analog De-emphasis Processing

The AD1859 includes three pins for implementing an external analog 50/15 μ s (or possibly the CCITT J. 17) de-emphasis frequency response characteristic. A control pin DEEMP (Pin 2) enables de-emphasis when it is asserted HI. Two analog outputs, EMPL (Pin 3) and EMPR (Pin 26) are used to switch the required analog components into the output stage of the AD1859. An analog implementation of de-emphasis is superior to a digital implementation in several ways. It is generally lower noise, since digital de-emphasis is usually created using recursive IIR filters, which inject limit cycle noise. Also the digital de-emphasis is being applied in front of the primary analog noise generation source, the DAC modulator, and its high frequency noise contributions are not attenuated. An analog de-emphasis circuit is downstream from the relatively “noisy” DAC modulator and thus provides a more effective noise reduction role (which was the original intent of the emphasis/de-emphasis scheme). A final key advantage of analog de-emphasis is that it is sample rate invariant, so that users can fully exploit the sample rate range of the AD1859 and simultaneously use de-emphasis. Digital implementations generally only support fixed, standard sample rates.

Digital Phase Locked Loop

The digital PLL is adaptive, and locks to the applied sample rate (on the LRCLK Pin 13) in 100 ms to 200 ms. The digital PLL is initially in “fast” mode, with a wide lock capture bandwidth.

The phase detector automatically switches the loop filter into “slow” mode as phase lock is gradually obtained. The loop bandwidth is 15 Hz in slow mode. Since the loop filter is first order, the digital PLL will reject jitter on the left/right clock above 15 Hz, with an attenuation of 6 dB per octave. The jitter rejection frequency response is shown in Figure 1.

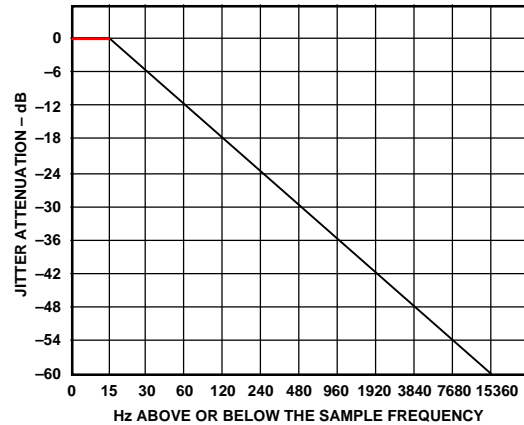

Figure 1. Digital PLL Jitter Rejection

OPERATING FEATURES

Serial Data Input Port

The AD1859 uses the frequency of the left/right input clock to determine the input sample rate. LRCLK must run continuously and transition twice per stereo sample period (except in the left-justified DSP serial port style mode, when it transitions four times per stereo sample period). The bit clock (BCLK) is edge sensitive and may be used in a gated or burst mode (i.e., a stream of pulses during data transmission followed by periods of inactivity). The bit clock is only used to write the audio data into the serial input port. It is important that the left/right clock is “clean” with monotonic rising and falling edge transitions and no excessive overshoot or undershoot which could cause false clock triggering of the AD1859.

The AD1859’s flexible serial data input port accepts data in two’s-complement, MSB-first format. The left channel data field always precedes the right channel data field. The input data consists of either 16 or 18 bits, as established by the 18/16 input control (Pin 8). All digital inputs are specified to TTL logic levels. The input data port is configured by control pins.

Serial Input Port Modes

The AD1859 uses two multiplexed input pins to control the mode configuration of the input data port. IDPM0 and IDPM1 program the input data port mode as follows:

IDPM1	IDPM0	Serial Input Port Mode
LO	LO	Right-Justified (See Figure 2)
LO	HI	I ² S-Justified (See Figure 3)
HI	LO	Left-Justified (See Figure 4)
HI	HI	Left-Justified DSP Serial Port Style (See Figure 5)

Figure 2 shows the right-justified mode. LRCLK is HI for the left channel, and LO for the right channel. Data is valid on the rising edge of BCLK. The MSB is delayed 14-bit clock periods (in 18-bit input mode) or 16-bit clock periods (in 16-bit input mode) from an LRCLK transition, so that when there are 64 BCLK periods per LRCLK period, the LSB of the data will be right-justified to the next LRCLK transition.

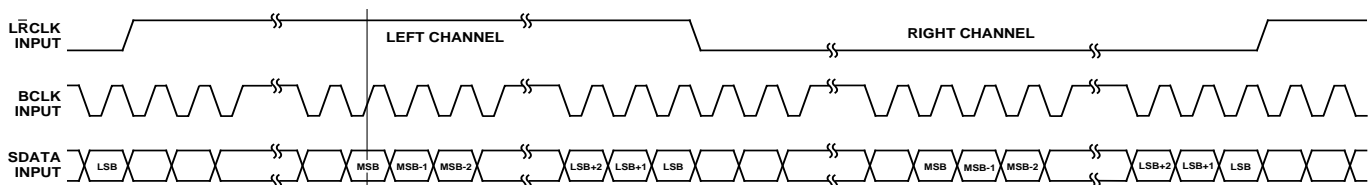

Figure 2. Right-Justified Mode

Figure 3 shows the I^2S -justified mode. \overline{LRCLK} is LO for the left channel, and HI for the right channel. Data is valid on the rising edge of BCLK. The MSB is left-justified to an \overline{LRCLK} transition but with a single BCLK period delay. The I^2S -justified mode can be used in either the 16-bit or the 18-bit input mode.

Figure 4 shows the left-justified mode. \overline{LRCLK} is HI for the left channel, and LO for the right channel. Data is valid on the rising edge of BCLK. The MSB is left-justified to an \overline{LRCLK} transition, with no MSB delay. The left-justified mode can be used in either the 16-bit or the 18-bit input mode.

Figure 5 shows the left-justified DSP serial port style mode. \overline{LRCLK} must pulse HI for at least one bit clock period before the MSB of the left channel is valid, and \overline{LRCLK} must pulse HI again for at least one bit clock period before the MSB of the right channel is valid. Data is valid on the falling edge of BCLK. The left-justified DSP serial port style mode can be used in either the 16-bit or the 18-bit input mode. Note that in this mode, it is the responsibility of the DSP to ensure that the left data is transmitted with the first \overline{LRCLK} pulse, and that the right data is transmitted with the second \overline{LRCLK} pulse, and that synchronism is maintained from that point forward.

Note that in 16-bit input mode, the AD1859 is capable of a $32 \times F_S$ BCLK frequency "packed mode" where the MSB is left-justified to an \overline{LRCLK} transition, and the LSB is right-justified to an \overline{LRCLK} transition. \overline{LRCLK} is HI for the left channel, and LO for the right channel. Data is valid on the rising edge of BCLK. Packed mode can be used when the AD1859 is programmed in either right-justified or left-justified mode. Packed mode is shown in Figure 6.

Serial Control Port

The AD1859 serial control port is SPI compatible. SPI (Serial Peripheral Interface) is a serial port protocol popularized by Motorola's family of microcomputer and microcontroller products. The write-only serial control port gives the user access to channel specific mute and attenuation. The AD1859 serial control port consists of three signals, control clock CCLK (Pin 19), control data CDATA (Pin 20), and control latch CLATCH (Pin 21). The control data input (CDATA) must be valid on the control clock (CCLK) rising edge, and the control clock (CCLK) must only make a LO to HI transition when there is valid data. The control latch (CLATCH) must make a LO to HI transition after the LSB has been clocked into the AD1859, while the control clock (CCLK) is inactive. The timing relation between these signals is shown in Figure 7.

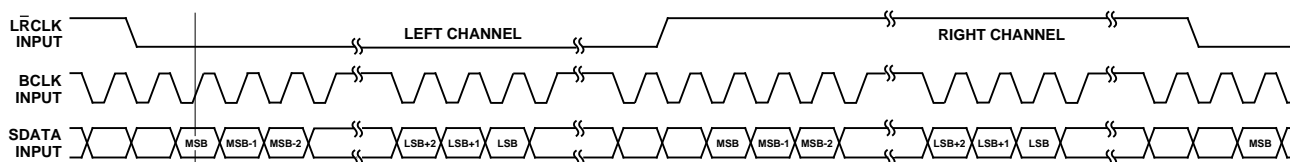

Figure 3. I^2S -Justified Mode

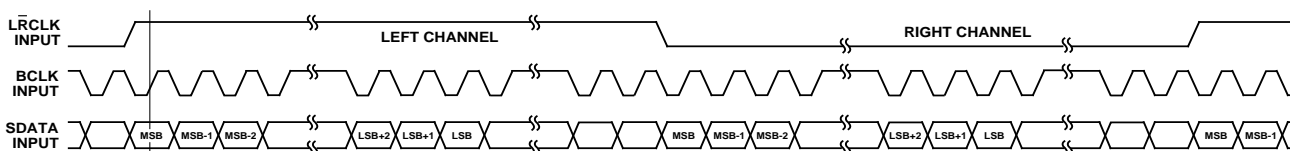

Figure 4. Left-Justified Mode

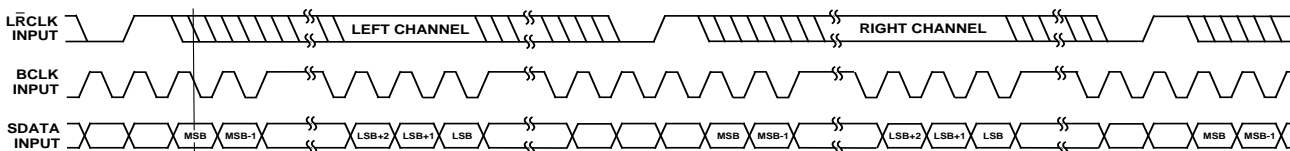

Figure 5. Left-Justified DSP Serial Port Style Mode

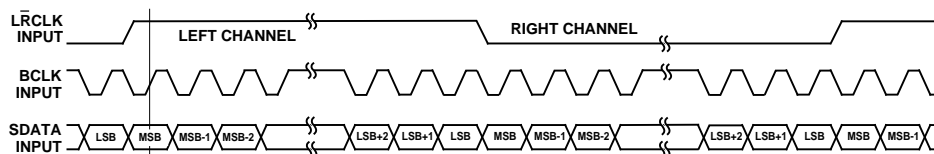

Figure 6. $32 \times F_S$ Packed Mode

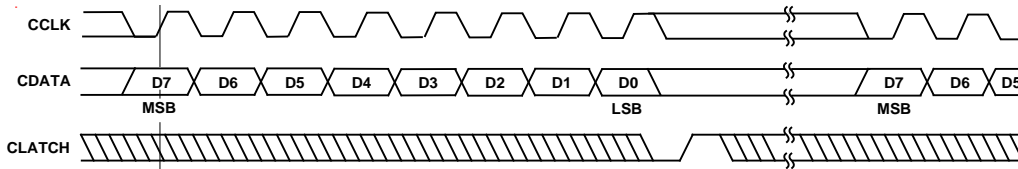

Figure 7. Serial Control Port Timing

MSB		DATA6	DATA5	DATA4	DATA3	DATA2	DATA1	DATA0	LSB	
DATA7	LEFT/RIGHT	Mute	Atten5	Atten4	Atten3	Atten2	Atten1	Atten0		
Right Channel = HI Left Channel = LO		Mute = HI Normal = LO	<p>00 0000 = 0.0dB 00 0001 = -1.0dB 00 0010 = -2.0dB 00 0011 = -3.0dB 00 0100 = -4.0dB 00 0101 = -5.0dB 00 0110 = -6.0dB 00 0111 = -7.0dB 00 1000 = -8.0dB * * * 11 1101 = -61.0dB 11 1110 = -62.0dB 11 1111 = -63.0dB</p>							

Figure 8. Serial Control Bit Definitions

The serial control port is byte oriented. The data is MSB first, and is unsigned. There is a control register for the left channel and a control register for the right channel, as distinguished by the MSB (DATA7). The bits are assigned as shown in Figure 8.

The left channel control register and the right channel control register have identical power up and reset default settings. DATA6, the Mute control bit, reset default state is LO, which is the normal (nonmuted) setting. DATA5:0, the Atten5 through Atten0 control bits, have a reset default value of 00 0000, which is an attenuation of 0.0 dB (i.e., full scale, no attenuation). The intent with these reset defaults is to enable AD1859 applications without requiring the use of the serial control port. For those users that do not use the serial control port, it is still possible to mute the AD1859 output by using the external MUTE (Pin 7) signal. It is recommended that the output be muted for approximately 1000 input sample periods during power-up or following any radical sample rate change (>5%) to allow the digital phase locked loop to settle.

Note that the serial control port timing is asynchronous to the serial data input port timing. Changes made to the attenuator level will be updated on the next edge of the LRCLK after the CLATCH write pulse. The AD1859 has been designed to resolve the potential for metastability between the LRCLK edge and the CLATCH write pulse rising edge. The attenuator setting is guaranteed to be valid even if the LRCLK edge and the CLATCH rising edge occur essentially simultaneously.

On-Chip Oscillator and Master Clock

The asynchronous master clock of the AD1859 can be supplied by either an external clock source applied to XTALI/MCLK or by connecting a crystal across the XTALI/MCLK and XTALO pins, and using the on-chip oscillator. If a crystal is used, it should be fundamental-mode and parallel-tuned. Figure 9 shows example connections.

The range of audio sample rates (as determined from the LRCLK input) supported by the AD1859 is a function of the master clock rate (i.e., the crystal frequency or external clock source frequency) applied. The highest sample rate supported can be computed as follows:

$$\text{Highest Sample Rate} = \text{Master Clock Frequency} \div 512$$

The lowest sample rate supported can be computed as follows:

$$\text{Lowest Sample Rate} = \text{Master Clock Frequency} \div 1024$$

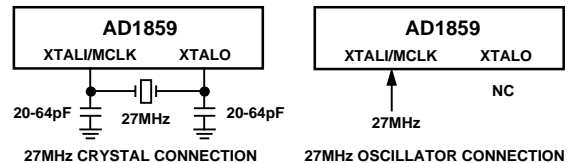

Figure 9. Crystal and Oscillator Connections

Figure 10 illustrates these relations. As can be seen in Figure 10, a 27 MHz MCLK or crystal frequency supports audio sample rates from approximately 28 kHz to 52 kHz.

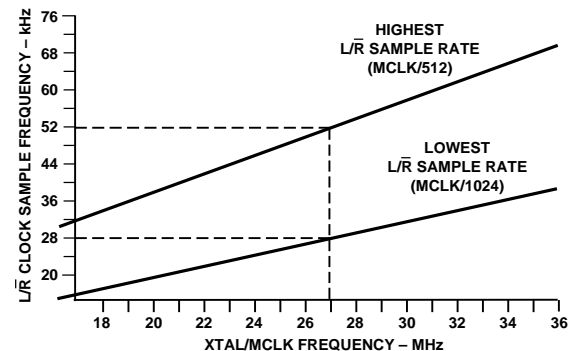

Figure 10. MCLK Frequency vs. L/R Clock Frequency

Mute and Attenuation

The AD1859 offers two methods of muting the analog output. By asserting the MUTE (Pin 7) signal HI, both the left channel and the right channel are muted. As an alternative, the user can assert the mute bit in the serial control registers HI for individual mute of either the left channel or the right channel. The

AD1859 has been designed to minimize pops and clicks when muting and unmuting the device. The AD1859 includes a zero crossing detector which attempts to implement attenuation changes on waveform zero crossings only. If a zero crossing is not found within 1024 input sample periods (approximately 23 ms at 44.1 kHz), the attenuation change is made regardless.

Output Drive, Buffering and Loading

The AD1859 analog output stage is able to drive a 2 k Ω load. If lower impedance loads must be driven, an external buffer stage such as the Analog Devices SSM2142 should be used. The analog output is generally ac coupled with a 10 μ F capacitor, even if the optional de-emphasis circuit is not used, as shown in Figure 17. It is possible to dc couple the AD1859 output into an op amp stage using the CMOUT signal as a bias point.

On-Chip Voltage Reference

The AD1859 includes an on-chip voltage reference that establishes the output voltage range. The nominal value of this reference is +2.25 V which corresponds to a line output voltage swing of 3 V p-p. The line output signal is centered around a voltage established by the CMOUT (common mode) output (Pin 1). The reference must be bypassed both on the FILT input (Pin 28) with 10 μ F and 0.1 μ F capacitors, and on the CMOUT output (Pin 1) with a 10 μ F and 0.1 μ F capacitors, as shown in Figures 17 and 18. The FILT pin must use the FGND ground, and the CMOUT pin must use the AGND ground. The on-chip voltage reference may be overdriven with an external reference source by applying this voltage to the FILT pin. CMOUT and FILT must still be bypassed as shown in Figures 17 and 18. An external reference can be useful to calibrate multiple AD1859 DACs to the same gain. Reference bypass capacitors larger than those suggested can be used to improve the signal-to-noise performance of the AD1859.

Power Down and Reset

The $\overline{\text{PD/RST}}$ input (Pin 11) is used to control the power consumed by the AD1859. When $\overline{\text{PD/RST}}$ is held LO, the AD1859 is placed in a low dissipation power-down state. When $\overline{\text{PD/RST}}$ is brought HI, the AD1859 becomes ready for normal operation. The master clock (XTALI/MCLK, Pin 16) must be running for a successful reset or power-down operation to occur. The $\overline{\text{PD/RST}}$ signal must be LO for a minimum of four master clock periods (approximately 150 ns with a 27 MHz XTALI/MCLK frequency).

When the $\overline{\text{PD/RST}}$ input (Pin 11) is asserted brought HI, the AD1859 is reset. All registers in the AD1859 digital engine (serial data port, interpolation filter and modulator) are zeroed, and the amplifiers in the analog section are shorted during the reset operation. The two registers in the serial control port are initialized to their default values. The user should wait 100 ms after bringing $\overline{\text{PD/RST}}$ HI before using the serial data input port and the serial control input port in order for the digital phase locked loop to re-acquire lock. The AD1859 has been designed to minimize pops and clicks when entering and exiting the power-down state.

Control Signals

The IDPM0, IDPM1, 18/1 $\overline{6}$, and DEEMP control inputs are normally connected HI or LO to establish the operating state of the AD1859. They can be changed dynamically (and asynchronously to the LRCLK and the master clock) as long as they are stable before the first serial data input bit (i.e., the MSB) is presented to the AD1859.

APPLICATIONS ISSUES

Interface to MPEG Audio Decoders

Figure 11 shows the suggested interface to the Analog Devices ADSP-21xx family of DSP chips, for which several MPEG audio decode algorithms are available. The ADSP-21xx supports 16 bits of data using a left-justified DSP serial port style format.

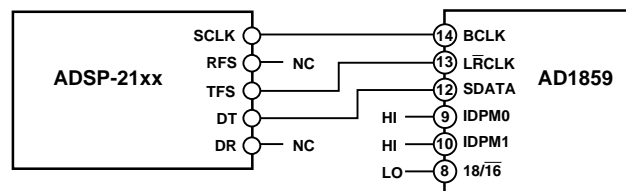

Figure 11. Interface to ADSP-21xx

Figure 12 shows the suggested interface to the Texas Instruments TMS320AV110 MPEG audio decoder IC. The TMS320AV110 supports 18 bits of data using a right-justified output format.

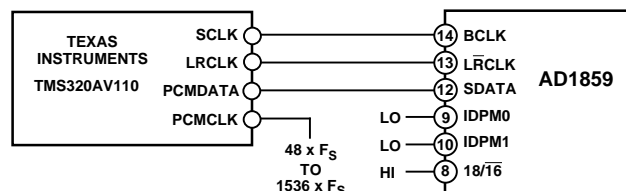

Figure 12. Interface to TMS320AV110

Figure 13 shows the suggested interface to the LSI Logic L64111 MPEG audio decoder IC. The L64111 supports 16 bits of data using a left-justified output format.

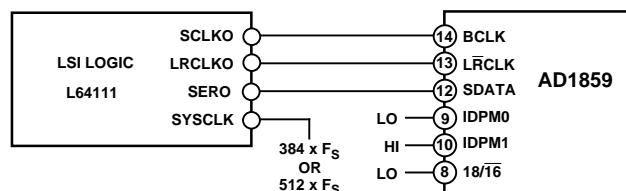

Figure 13. Interface to L64111

Figure 14 shows the suggested interface to the Philips SAA2500 MPEG audio decoder IC. The SAA2500 supports 18 bits of data using an I²S compatible output format.

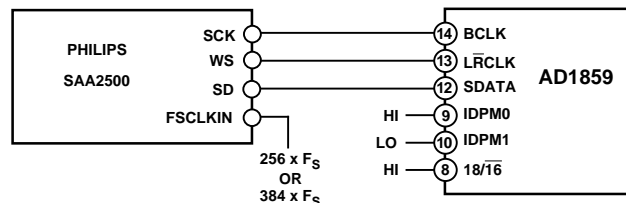

Figure 14. Interface to SAA2500

AD1859

Figure 15 shows the suggested interface to the Zoran ZR38000 DSP chip, which can act as an MPEG audio or AC-3 audio decoder. The ZR38000 supports 16 bits of data using a left-justified output format.

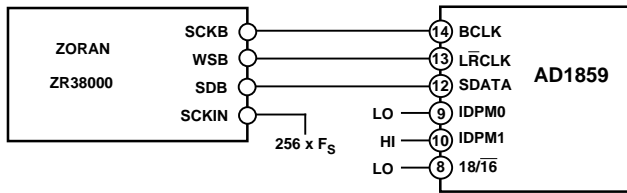

Figure 15. Interface to ZR38000

Figure 16 shows the suggested interface to the C-Cube Microsystems CL480 MPEG system decoder IC. The CL480 supports 16 bits of data using a right-justified output format.

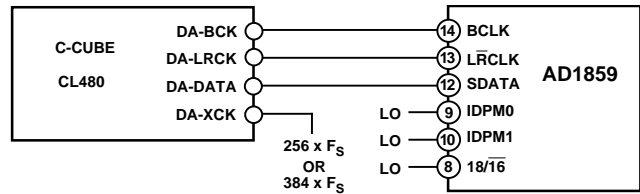

Figure 16. Interface to CL480

Layout and Decoupling Considerations

The recommended decoupling, bypass circuits for the AD1859 are shown in Figure 17. Figure 17 illustrates a connection diagram for systems which do not require de-emphasis support. The recommended circuit connection for system including de-emphasis is shown in Figure 18.

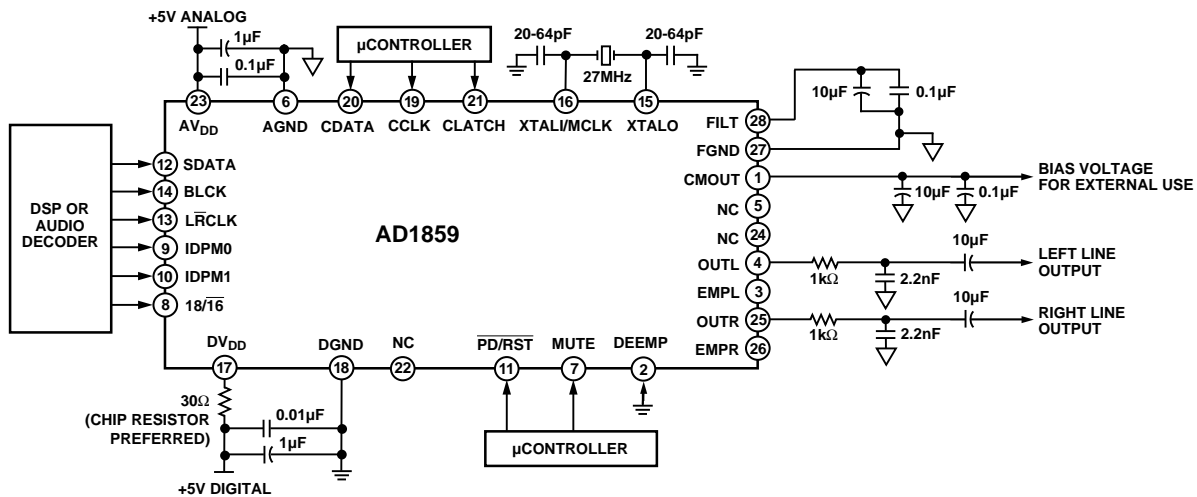

Figure 17. Recommended Circuit Connection (Without De-emphasis)

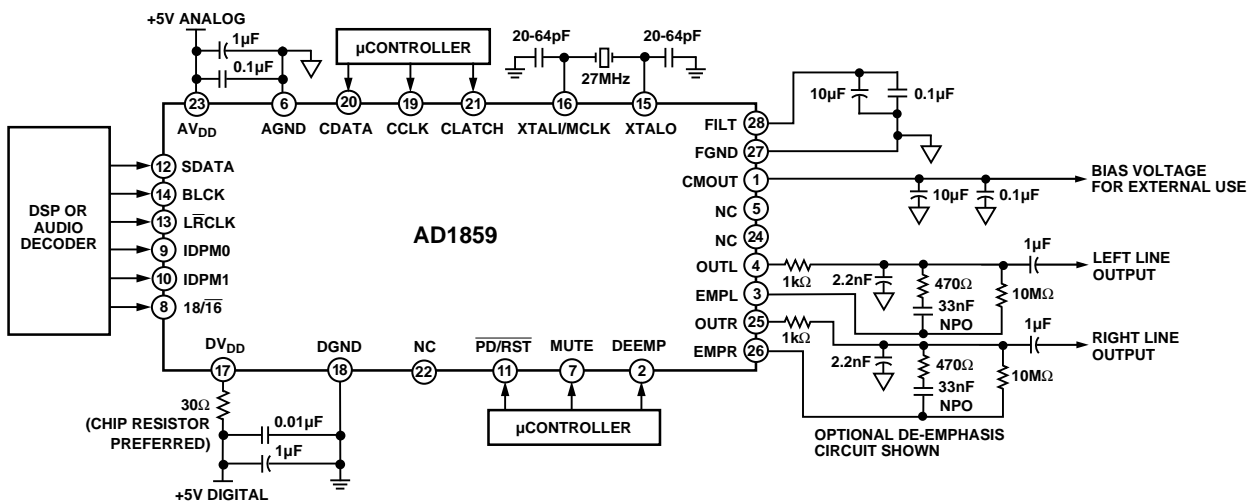

Figure 18. Recommended Circuit Connection (With De-emphasis)

PCB and Ground Plane Recommendations

The AD1859 ideally should be located above a split ground plane, with the digital pins over the digital ground plane, and the analog pins over the analog ground plane. The split should occur between Pins 6 and 7 and between Pins 22 and 23 as shown in Figure 19. The ground planes should be tied together at one spot underneath the center of the package with an approximately 3 mm trace. This ground plane strategy minimizes RF transmission and reception as well as maximizes the AD1859's analog audio performance.

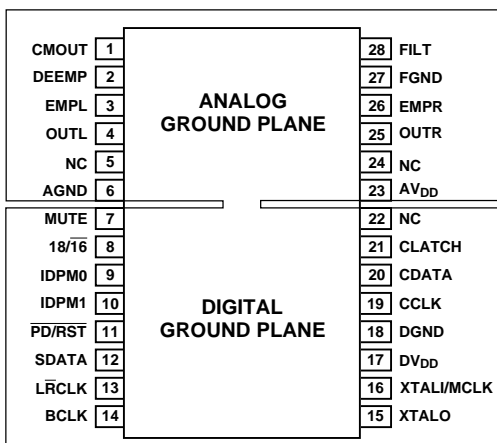

Figure 19. Recommended Ground Plane

TIMING DIAGRAMS

The serial data port timing is shown in Figures 20 and 21. The minimum bit clock HI pulse width is t_{DBH} , and the minimum bit clock LO pulse width is t_{DBL} . The minimum bit clock period is t_{DBP} . The left/right clock minimum setup time is t_{DLS} , and the left/right clock minimum hold time is t_{DLH} . The serial data minimum setup time is t_{DDS} , and the minimum serial data hold time is t_{DDH} .

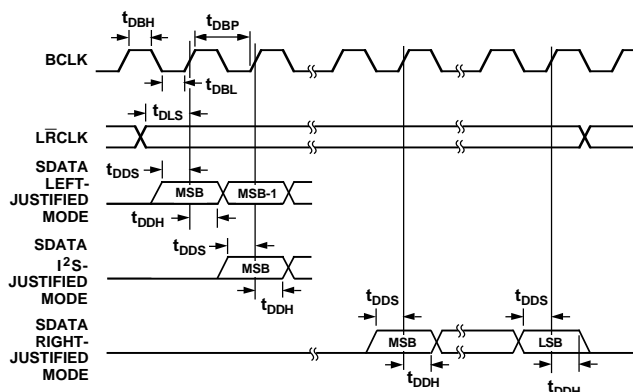

Figure 20. Serial Data Port Timing

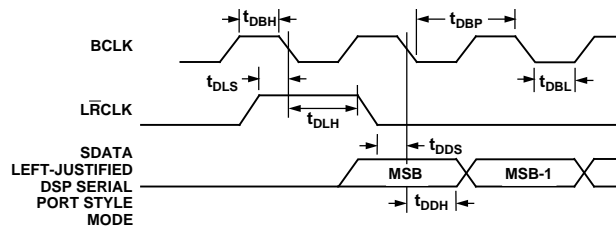

Figure 21. Serial Data Input Port Timing DSP Serial Port Style

The serial control port timing is shown in Figure 22. The minimum control clock HI pulse width is t_{CCH} , and the minimum control clock LO pulse width is t_{CCL} . The minimum control clock period is t_{CCP} . The control data minimum setup time is t_{CSU} , and the minimum control data hold time is t_{CHD} . The minimum control latch delay is t_{CLD} , the minimum control latch LO pulse width is t_{CLL} , and the minimum control latch HI pulse width is t_{CLH} .

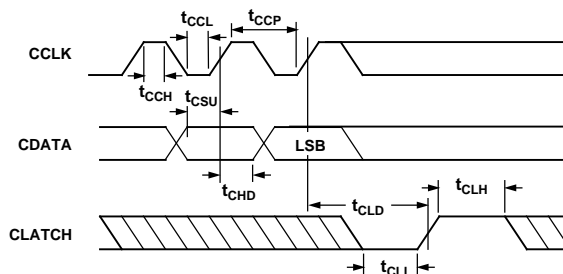

Figure 22. Serial Control Port Timing

The master clock (or crystal input) and power down/reset timing is shown in Figure 23. The minimum MCLK period is t_{MCP} , which determines the maximum MCLK frequency at F_{MC} . The minimum MCLK HI and LO pulse widths are t_{MCH} and t_{MCL} , respectively. The minimum reset LO pulse width is t_{PDRP} (four XTALI/MCLK periods) to accomplish a successful AD1859 reset operation.

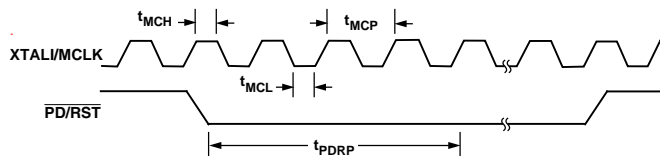

Figure 23. MCLK and Power Down/Reset Timing

AD1859

TYPICAL PERFORMANCE

Figures 24 through 27 illustrate the typical analog performance of the AD1859 as measured by an Audio Precision System One. Signal-to-Noise (dynamic range) and THD+N performance is shown under a range of conditions. Note that there is a small variance between the AD1859 analog performance specifications and some of the performance plots. This is because the Audio Precision System One measures THD and noise over a

20 Hz to 24 kHz bandwidth, while the analog performance is specified over a 20 Hz to 20 kHz bandwidth (i.e., the AD1859 performs slightly better than the plots indicate). Figure 28 shows the power supply rejection performance of the AD1859. The channel separation performance of the AD1859 is shown in Figure 29. The AD1859's low level linearity is shown in Figure 30. The digital filter transfer function is shown in Figure 31.

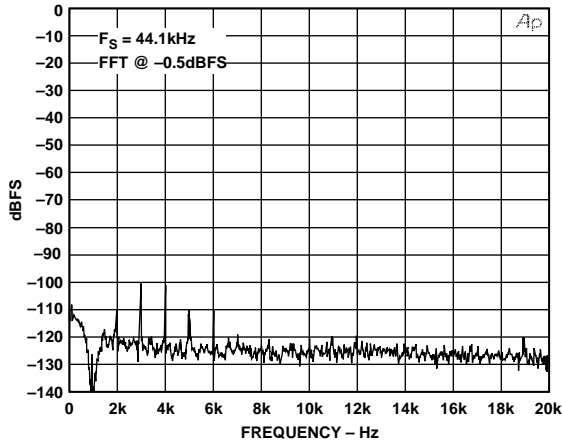

Figure 24. 1 kHz Tone at -0.5 dBFS (16K-Point FFT)

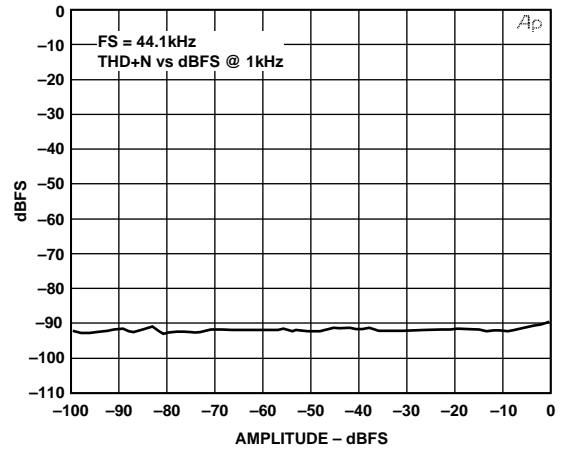

Figure 27. THD+N vs. Amplitude at 1 kHz

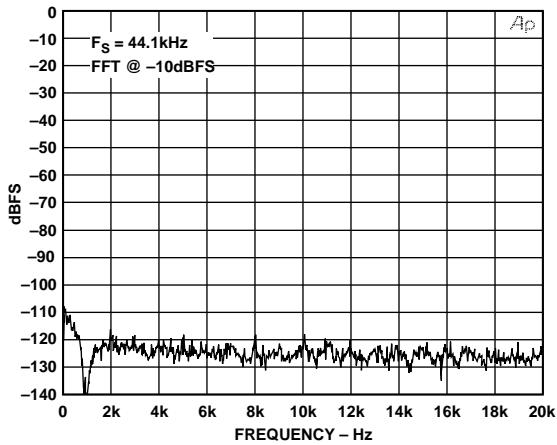

Figure 25. 1 kHz Tone at -10 dBFS (16K-Point FFT)

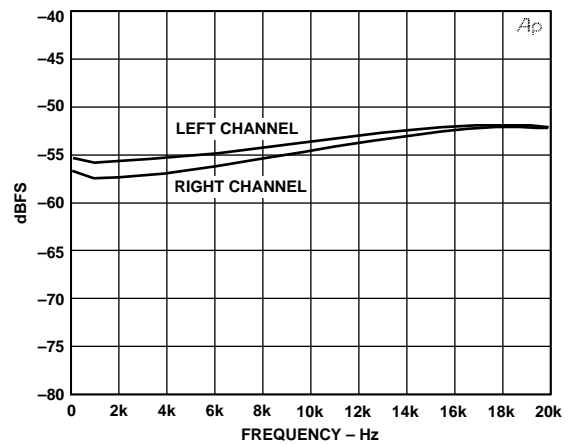

Figure 28. Power Supply Rejection to 300 mV p-p on AV_{DD}

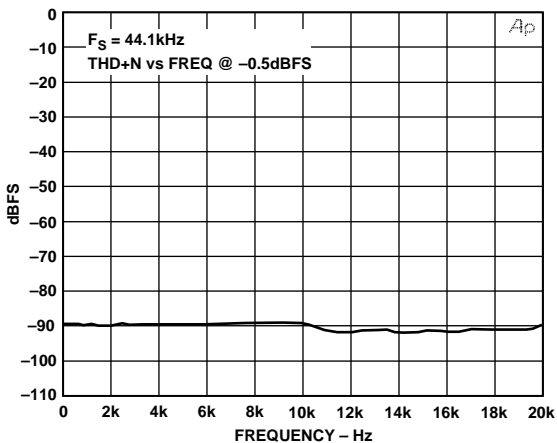

Figure 26. THD+N vs. Frequency at -0.5 dBFS

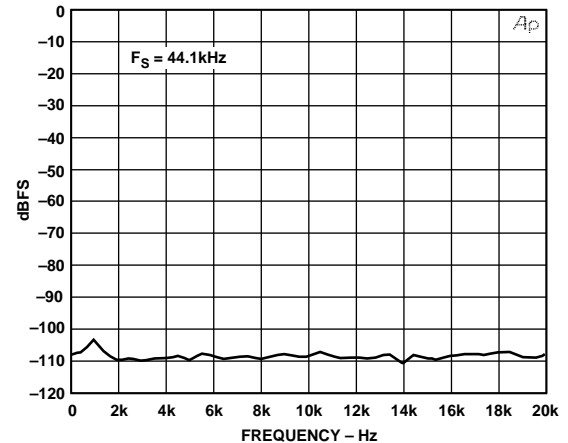

Figure 29. Channel Separation vs. Frequency at -0.5 dBFS

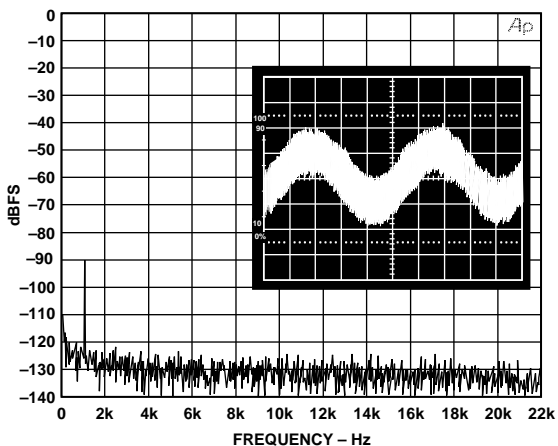

Figure 30. 1 kHz Tone at -90 dBFS (16K-Point FFT) Including Time Domain Plot Bandlimited to 22 kHz

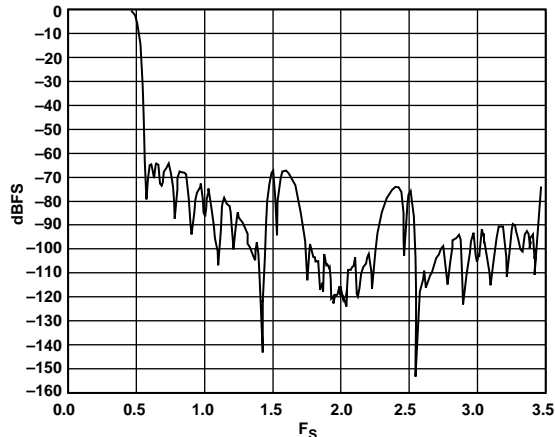

Figure 31. Digital Filter Signal Transfer Function to $3.5 \times F_s$

Application Circuits

Figure 32 illustrates a 600 ohm line driver using the Analog Devices SSM2017 and SSM2142 components. Figure 33 illustrates a “Numerically Controlled Oscillator” (NCO) that can be implemented in programmable logic or a system ASIC to provide the synchronous bit and left/right clocks from 27 MHz for MPEG audio decoders. Note that the bit clock and left/right clock outputs are highly jittered, but this jitter should be

perfectly acceptable. MPEG audio decoders are insensitive to this clock jitter (using these signals to clock audio data from their output serial port, and perhaps to decrement their audio/video synchronization timer), while the AD1859 will reject the left/right clock jitter by virtue of its on-chip digital phase locked loop. Contact Analog Devices Computer Products Division Customer Support at (617) 461-3881 or cpd_support@analog.com for more information on this NCO circuit.

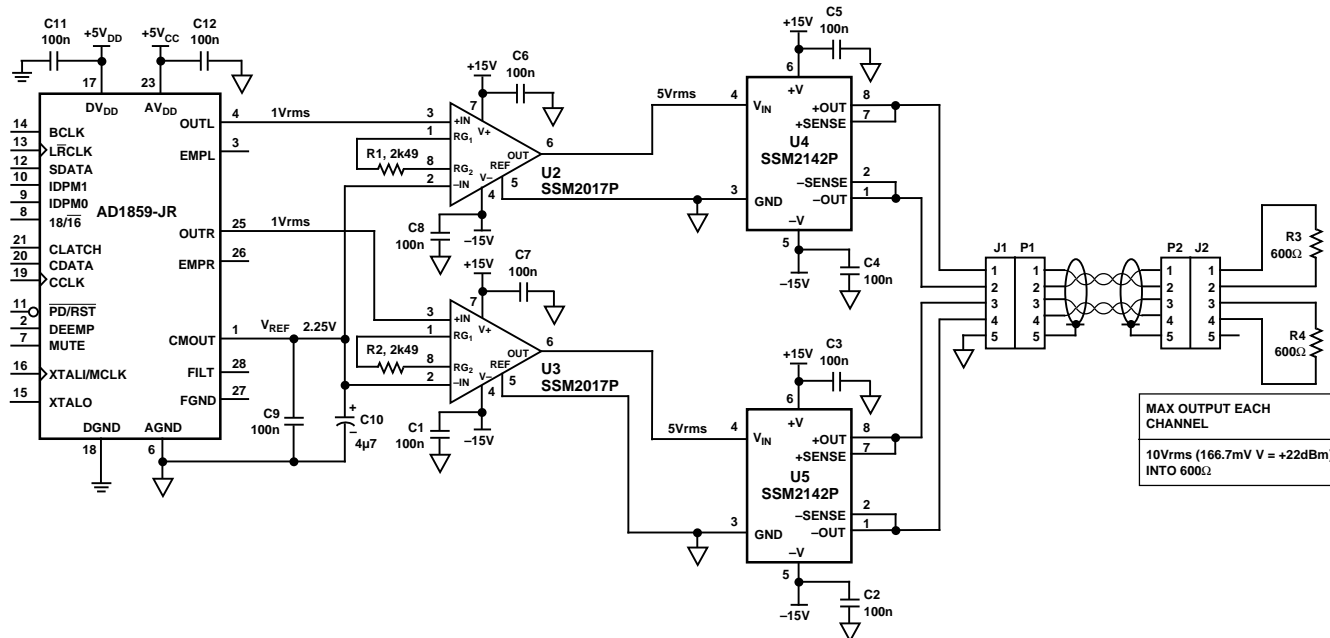

Figure 32. 600 Ohm Balanced Line Driver

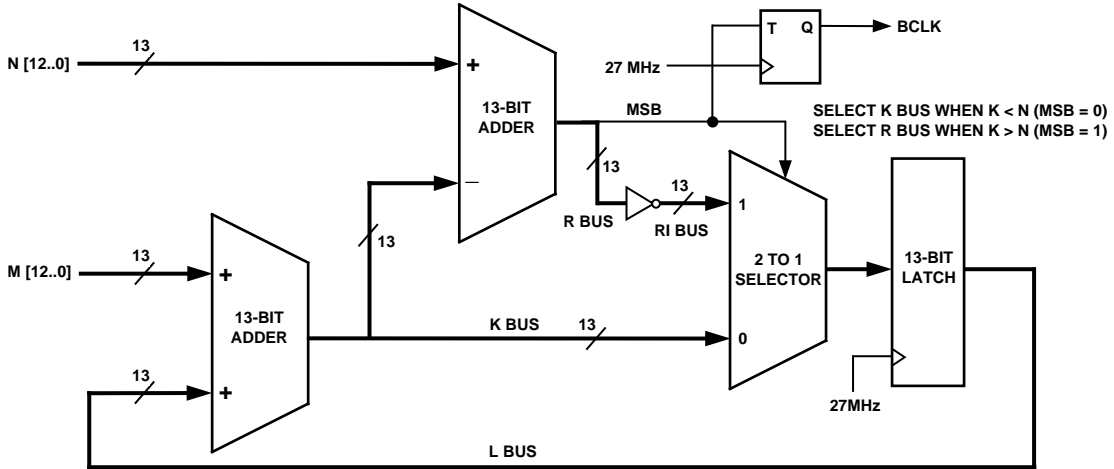
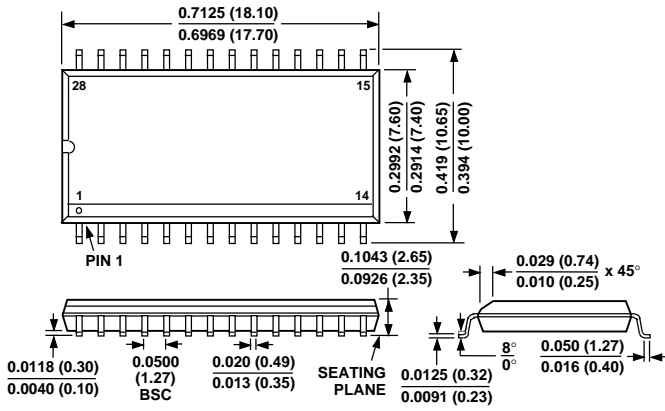

Figure 33. Numerically Controlled Oscillator Circuit

OUTLINE DIMENSIONS

Dimensions shown in inches and (mm).

28-Lead Wide-Body SO (R-28)



28-Lead Shrink Small Outline Package (SSOP) (RS-28)

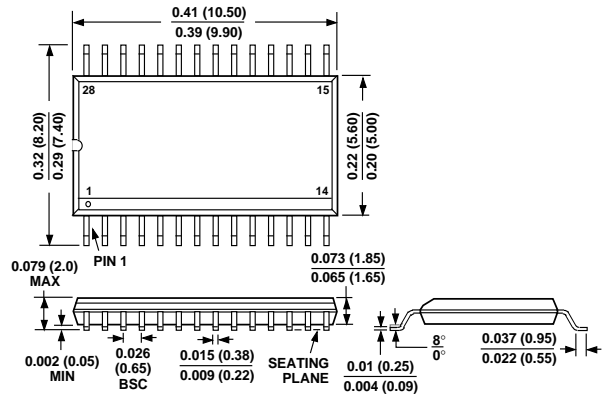

Copyright © Each Manufacturing Company.

All Datasheets cannot be modified without permission.

This datasheet has been download from :

www.AllDataSheet.com

100% Free DataSheet Search Site.

Free Download.

No Register.

Fast Search System.

www.AllDataSheet.com