

# Am29861 - 64

High Performance Bus Transceivers

## DISTINCTIVE CHARACTERISTICS

- High-speed symmetrical bidirectional transceivers
  - Noninverting  $t_{PD} = 5.0ns$  typ
  - Inverting  $t_{PD} = 4.5ns$  typ
- 200mV minimum input hysteresis on input data ports
- Three-state outputs glitch-free during power-up and down. Outputs have Schottky clamp to ground
- 48mA commercial  $I_{OL}$ , 32mA military  $I_{OL}$
- Low input/output capacitance
- $I_{OH}$  specified 2.0V and 2.4V

## GENERAL DESCRIPTION

The Am29860 Series bus transceivers provide high performance bus interface buffering for wide data/address paths or buses carrying parity. The Am29863/64 9-bit transceivers have NOR-ed output enables for maximum control flexibility. All transceiver data inputs have 200mV minimum input hysteresis to provide improved noise rejection.

All of the Am29800 high performance interface family are designed for high capacitance load drive capability while providing low capacitance bus loading at both inputs and outputs. All inputs are Schottky diode inputs, and all outputs are designed for low capacitance bus loading in the high impedance state.

## BLOCK DIAGRAM

### Am29861/Am29862 10-BIT TRANSCEIVERS

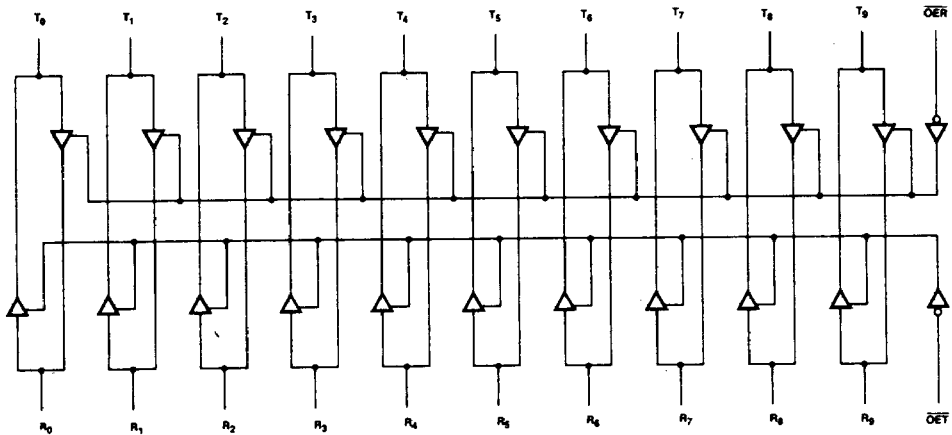

BD001060

### CONNECTION DIAGRAM Top View

#### Am29861/Am29862 10-BIT TRANSCEIVERS

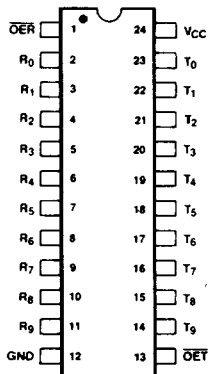

CD001150

### LOGIC SYMBOL

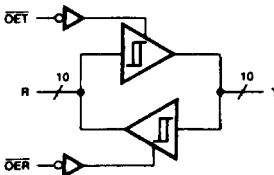

Am29861 (NONINVERTING)

LS000370

### ORDERING INFORMATION

AMD products are available in several packages and operating ranges. The order number is formed by a combination of the following: Device number, speed option (if applicable), package type, operating range and screening option (if desired).

Am29861 - 64

D

C

B

Screening Option  
Blank - Standard processing  
B - Burn-in

Temperature (See Operating Range)  
C - Commercial (0°C to +70°C)  
M - Military (-55°C to +125°C)

Package

D - 24-pin SLIM DIP (D-24-SLIM)  
L - 28-pin Leadless Chip Carrier (L-28-1)  
X - Dice

Device type

High Performance Bus Transceiver

#### Valid Combinations

Am29861	DC, DCB, DM,
Am29862	DMB
Am29863	LC, LCB, LM,
Am29864	LMB
	XC, XM

#### Valid Combinations

Consult the AMD sales office in your area to determine if a device is currently available in the combination you wish.

### CONNECTION DIAGRAM Top View

#### Am29863/Am29864 9-BIT TRANSCEIVERS

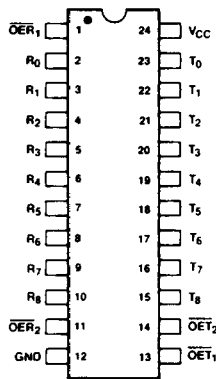

GD001140

### LOGIC SYMBOL

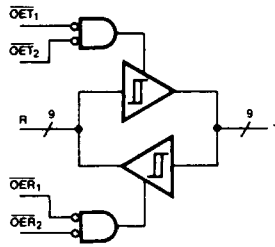

Am29863 (NONINVERTING)

LS000380

## PIN DESCRIPTION

Pin No.	Name	I/O	Description
<b>Am29861/Am29862</b>			
1	$\overline{OET}$	I	When LOW in conjunction with $\overline{OER}$ HIGH activates the RECEIVE mode.
13	$\overline{OER}$	I	When LOW in conjunction with $\overline{OET}$ HIGH activates the TRANSMIT mode.
	$R_i$	I/O	10-bit RECEIVE input/output.
	$T_i$	I/O	10-bit TRANSMIT input/output.
<b>Am29863/Am29864</b>			
	$\overline{OET}_i$	I	When both are LOW in conjunction with any $\overline{OET}_i$ HIGH indicates the RECEIVE mode.
	$\overline{OET}_i$	I	When both are LOW in conjunction with any $\overline{OER}_i$ HIGH indicates the TRANSMIT mode.
	$R_i$	I/O	9-bit RECEIVE input/output.
	$T_i$	I/O	9-bit TRANSMIT input/output.

## FUNCTION TABLES

**Am29861/Am2983 (Noninverting)**

Inputs				Outputs		Function
$\overline{OET}$	$\overline{OER}$	$R_i$	$T_i$	$R_i$	$T_i$	
L	H	L	N/A	N/A	L	Transmitting
L	H	H	N/A	N/A	H	Transmitting
H	L	N/A	L	L	N/A	Receiving
H	L	N/A	H	H	N/A	Receiving
H	H	X	X	Z	Z	Hi-Z

**Am29862/Am29864 (Inverting)**

Inputs				Outputs		Function
$\overline{OET}$	$\overline{OER}$	$R_i$	$\overline{T}_i$	$R_i$	$\overline{T}_i$	
L	H	L	N/A	N/A	H	Transmitting
L	H	H	N/A	N/A	L	Transmitting
H	L	N/A	L	H	N/A	Receiving
H	L	N/A	H	L	N/A	Receiving
H	H	X	X	Z	Z	Hi-Z

H = HIGH  
L = LOW  
Z = High Impedance

X = Don't Care  
N/A = Not Applicable

### Am29863/Am29864 9-BIT TRANSCEIVERS

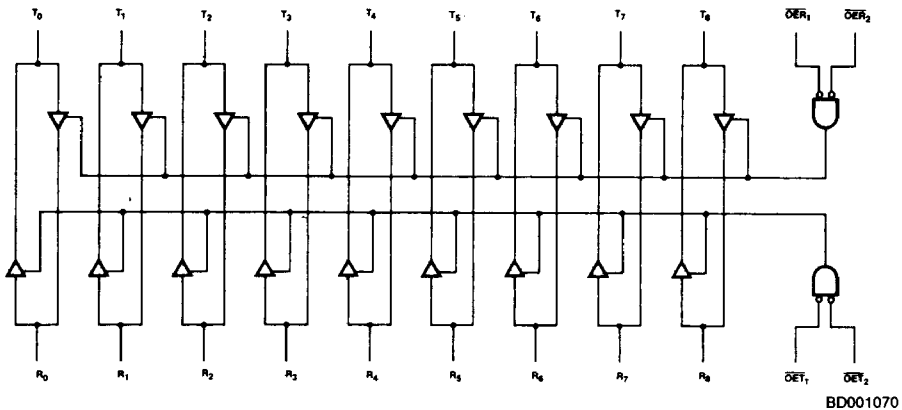

### ABSOLUTE MAXIMUM RATINGS

Storage Temperature ..... -65°C to +150°C  
 Ambient Temperature with  
 Power Applied ..... -55°C to +125°C  
 Supply Voltage to Ground Potential  
 Continuous ..... -0.5V to +7.0V  
 DC Voltage Applied to Output  
 for High Output State ..... -1.5V to  $V_{CCmax}$   
 DC Input voltage ..... -0.5V to +5.5V  
 DC Output Current, Into Outputs ..... 100mA  
 DC Input Current ..... -30mA to +5.0mA

*Stresses above those listed under ABSOLUTE MAXIMUM RATINGS may cause permanent device failure. Functionality at or above these limits is not implied. Exposure to absolute maximum ratings for extended periods may affect device reliability.*

### OPERATING RANGES

Commercial (C) Devices  
 Temperature ..... 0°C to +70°C  
 Supply Voltage ..... +4.75V to +5.25V  
 Military (M) Devices  
 Temperature ..... -55°C to +125°C  
 Supply Voltage ..... +4.5V to +5.5V  
*Operating ranges define those limits over which the functionality of the device is guaranteed.*

### DC CHARACTERISTICS over operating range unless otherwise specified

Parameter	Description	Test Conditions	Min	Typ	Max	Units	
VOH	Output HIGH Voltage	$V_{CC} = \text{MIN}$ $V_{IN} = V_{IH}$ or $V_{IL}$	$I_{OH} = -15\text{mA}$	2.4			V
			$I_{OH} = -24\text{mA}$	2.0			
VOL	Output LOW Voltage	$V_{CC} = \text{MIN}$ $V_{IN} = V_{IH}$ or $V_{IL}$	MIL, $I_{OL} = 32\text{mA}$			0.5	V
			COM'L, $I_{OL} = 48\text{mA}$			0.5	
V <sub>IH</sub>	Input HIGH Level	Guaranteed input logical HIGH voltage for all inputs	2.0			V	
V <sub>IL</sub>	Input LOW Level	Guaranteed input logical LOW voltage for all inputs			0.8	V	
V <sub>I</sub>	Input Clamp Voltage	$V_{CC} = \text{MIN}$ , $I_{IN} = -18\text{mA}$			-1.2	V	
V <sub>HYST</sub>	Input Hysteresis	Tested output is connected to AC load test circuit	200			mV	
I <sub>IL</sub>	Input LOW Current	$V_{CC} = \text{MAX}$ , $V_{IN} = 0.4\text{V}$			-1.0	mA	
I <sub>IH</sub>	Input HIGH Current	$V_{CC} = \text{MAX}$ , $V_{IN} = 2.7\text{V}$			50	μA	
I <sub>I</sub>	Input HIGH Current	$V_{CC} = \text{MAX}$ , $V_{IN} = 5.5\text{V}$			1.0	mA	
I <sub>OZH</sub>	Output Off-State Output Current (HI-Z)	$V_{CC} = \text{MAX}$ , $V_O = 2.4\text{V}$			50	μA	
I <sub>OZL</sub>	Output Off-State Output Current (HI-Z)	$V_{CC} = \text{MAX}$ , $V_O = 0.4\text{V}$			-1.0	mA	
I <sub>SC</sub>	Output Short Circuit Current	$V_{CC} = \text{MAX}$	-75		-250	mA	
I <sub>CC</sub>	Supply Current	$V_{CC} = \text{MAX}$ Outputs Open	Over Temperature Range			160	mA
			+70°C			150	
			+125°C			140	

8

## SWITCHING TEST CIRCUIT

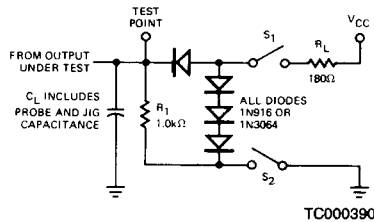

Note: Pulse Generator for All Pulses: Rate  $\leq$  10MHz;  $Z_0 = 50\Omega$ ;  $t_r \leq 2.5\text{ns}$ ;  $t_f \leq 2.5\text{ns}$ .

SWITCHING CHARACTERISTICS ( $T_A = +25^\circ\text{C}$ ,  $V_{CC} = 5.0\text{V}$ )

Parameters	Description	Test Conditions	Min	Typ	Max	Units
$t_{PLH}$	Propagation Delay from $R_i$ to $T_i$ or $T_i$ to $R_i$ Am29861/Am29863 (Noninverting)	$C_L = 50\text{pF}$		4.8	6.0	ns
$t_{PHL}$				5.2	6.2	ns
$t_{PLH}$		$C_L = 300\text{pF}$		8	11	ns
$t_{PHL}$				11	14	ns
$t_{PLH}$	Propagation Delay from $R_i$ to $\bar{T}_i$ or $\bar{T}_i$ to $R_i$ Am29862/Am29864 (Inverting)	$C_L = 50\text{pF}$		4.0	5.2	ns
$t_{PHL}$				4.9	5.9	ns
$t_{PLH}$		$C_L = 300\text{pF}$		7.3	10	ns
$t_{PHL}$				10.5	12.9	ns
$t_{ZH}$	Output Enable Time $\overline{\text{OET}}$ to $T_i$ and $\text{OER}$ to $R_i$	$C_L = 50\text{pF}$		6.5	12	ns
$t_{ZL}$				9.5	12	ns
$t_{ZH}$		$C_L = 300\text{pF}$		11	17	ns
$t_{ZL}$				17	21	ns
$t_{HZ}$	Output Disable Time $\text{OET}$ to $T_i$ and $\overline{\text{OER}}$ to $R_i$	$C_L = 5\text{pF}$		3.5	8.0	ns
$t_{LZ}$				3.5	8.0	ns
$t_{HZ}$		$C_L = 50\text{pF}$		11.2	16	ns
$t_{LZ}$				4.5	9.0	ns

## SWITCHING CHARACTERISTICS over operating range unless otherwise specified

Parameters	Description	Test Conditions	COMMERCIAL		MILITARY		Units
			Min	Max	Min	Max	
$t_{PLH}$	Propagation Delay from $R_i$ to $T_i$ or $T_i$ to $R_i$ Am29861/Am29863 (Noninverting)	$C_L = 50\text{pF}$		8		10	ns
$t_{PHL}$				8		10	ns
$t_{PLH}$		$C_L = 300\text{pF}$		15		17	ns
$t_{PHL}$				15		17	ns
$t_{PLH}$	Propagation Delay from $R_i$ to $\bar{T}_i$ or $\bar{T}_i$ to $R_i$ Am29862/Am29864 (Inverting)	$C_L = 50\text{pF}$		7.0		9.0	ns
$t_{PHL}$				7.5		9.5	ns
$t_{PLH}$		$C_L = 300\text{pF}$		14		16	ns
$t_{PHL}$				14		16	ns
$t_{ZH}$	Output Enable Time $\overline{\text{OET}}$ to $T_i$ or $\text{OER}$ to $R_i$	$C_L = 50\text{pF}$		15		17	ns
$t_{ZL}$				15		17	ns
$t_{ZH}$		$C_L = 300\text{pF}$		20		22	ns
$t_{ZL}$				23		25	ns
$t_{HZ}$	Output Disable Time $\text{OET}$ to $T_i$ or $\overline{\text{OER}}$ to $R_i$	$C_L = 5\text{pF}$		9		10	ns
$t_{LZ}$				9		10	ns
$t_{HZ}$		$C_L = 50\text{pF}$		17		19	ns
$t_{LZ}$				12		12	ns

## SWITCHING WAVEFORMS

## PROPAGATION DELAY

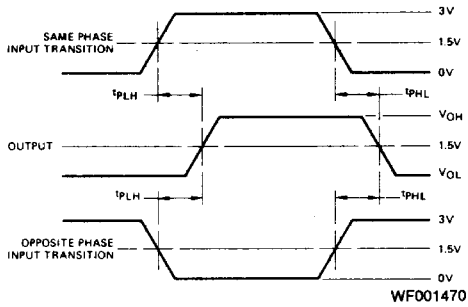

## ENABLE AND DISABLE TIMES

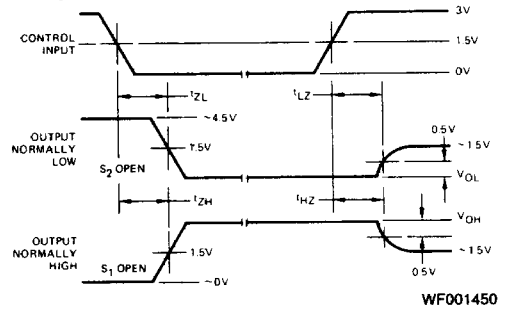

- Notes: 1. Diagram shown for Input Control Enable-LOW and Input Control Disable-HIGH.  
 2.  $S_1$  and  $S_2$  of Load Circuit are closed except where shown.