

ICM7215 6-Digit 4-Function LED Stopwatch Circuit

FEATURES

- Four functions: start/stop/reset, split, taylor, time out
- Six digit display: ranges up to 59 minutes 59.99 seconds
- High LED drive current: 13mA peak per segment at 16.7% duty cycle with 4.0 volt supply
- Requires only three low cost SPST switches without loss of accuracy: start/stop, reset, display unlock
- Chip enable pin turns off both segment and digit outputs; can be used for multiple circuits driving one display
- Low battery indicator
- Digit blanking on seconds and minutes
- Wide operating range: 2.0 to 5.0 volts
- 1KHz multiplex rate prevents flickering display
- Can be used easily in four different single function stopwatches or two two-function stopwatches: start/stop/reset with time-out, split with taylor. The component count for a three- or four-function stopwatch will be slightly greater.
- Retrofit to ICM7205 for split and/or taylor applications

GENERAL DESCRIPTION

The ICM7215 is a fully integrated six digit LED stopwatch circuit fabricated with Intersil's low threshold metal gate CMOS process. The circuit interfaces directly with a six digit/seven segment common cathode LED display. The low battery indicator can be connected to the decimal point anode or to a separate LED. The only components required for a complete stopwatch are the display, three SPST switches, a 3.2768MHz crystal, a trimming capacitor, three AA batteries and an on-off switch. For a two function stopwatch, or to add a display off feature, one additional slide switch is required. The circuit divides the oscillator frequency by 2^{15} to obtain 100Hz, which is fed to the fractional seconds, seconds and minutes counters, while an intermediate frequency is used to obtain the 1/6 duty cycle 1.07KHz multiplex waveforms. The blanking logic provides leading zero blanking for seconds and minutes independently of the clock. The ICM7215 is packaged in a 24-lead plastic DIP.

BLOCK DIAGRAM

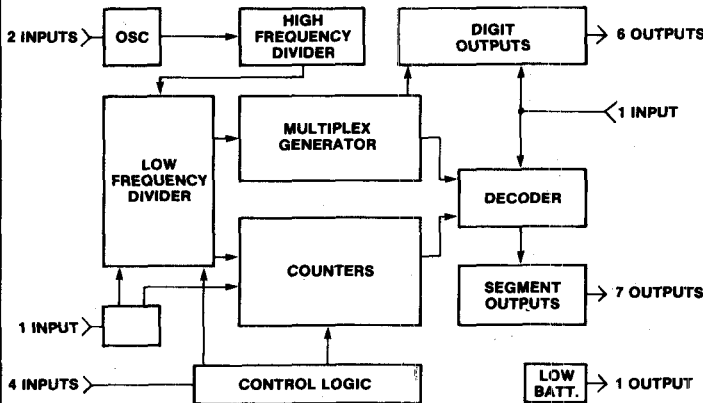

PIN CONFIGURATION (OUTLINE DRAWING PG)

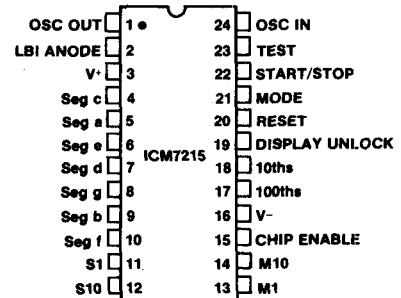

ORDERING INFORMATION

Order devices by following part number ICM7215 1 PG
Order dice by following part number ICM7215/D

ABSOLUTE MAXIMUM RATINGS

Supply Voltage	5.5 V
Power Dissipation (Note 1)	0.75 W
Operating Temperature	-20°C to +70°C
Storage Temperature	-55°C to +125°C
Input and Output Voltage	equal to but never exceeding the supply voltage

Stresses above those listed under Absolute Maximum Ratings may cause permanent damage to the device. These are stress ratings only, and functional operation of the device at these or any other conditions above those indicated in the operational sections of the specifications is not implied. Exposure to absolute maximum rating conditions for extended periods may affect device reliability.

OPERATING CHARACTERISTICS:

TEST CONDITIONS: $T_A = +25^\circ\text{C}$, stopwatch circuit, $V^+ = 4.0\text{V}$ unless otherwise specified.

PARAMETER	SYM	CONDITIONS	MIN	TYP	MAX	UNITS
Supply Voltage	V^+	$-20^\circ\text{C} \leq T_A \leq +70^\circ\text{C}$	2.0		5.0	V
Supply Current	I^+	Display off		0.6	1.5	mA
Segment Current	I_{SEG}	5 segments lit				
Peak		1.8 Volts across display	9.0	13.2		
Average				2.2		
Switch Actuation Current	I_{SW}	All inputs except chip enable		20	50	μA
Switch Actuation Current		Chip enable		50	200	
Digit Leakage Current	I_{DLK}	$V_{DIG} = 2.0\text{V}$			50	
Segment Leakage Current	I_{SLK}	$V_{SEG} = 2.0\text{V}$			100	
Low Battery Indicator						
Trigger Voltage	V_{LBI}		2.2		2.8	V
LBI Output Current	I_{LBI}	$V^+ = 2.0\text{V}$, $V_{LBI} = 1.6\text{V}$		2.0		mA
Oscillator Stability	f_{STAB}	$V^+ = 2.0\text{V}$ to $V^+ = 5.0\text{V}$		6		PPM
Oscillator Transconductance	g_m	$V^+ = 2.0\text{V}$	120			μmho
Oscillator Input Capacitance	C_{OSCI}		24	30	36	pF

NOTE 1: The output devices on the ICM7215 have very low impedance characteristics, especially the digit cathode drivers. If these devices are shorted to a low impedance power supply, the current could be as high as 300mA. This will not damage the device momentarily, but if the short circuit condition is not removed immediately probable device failure will occur.

7

STOPWATCH CIRCUIT

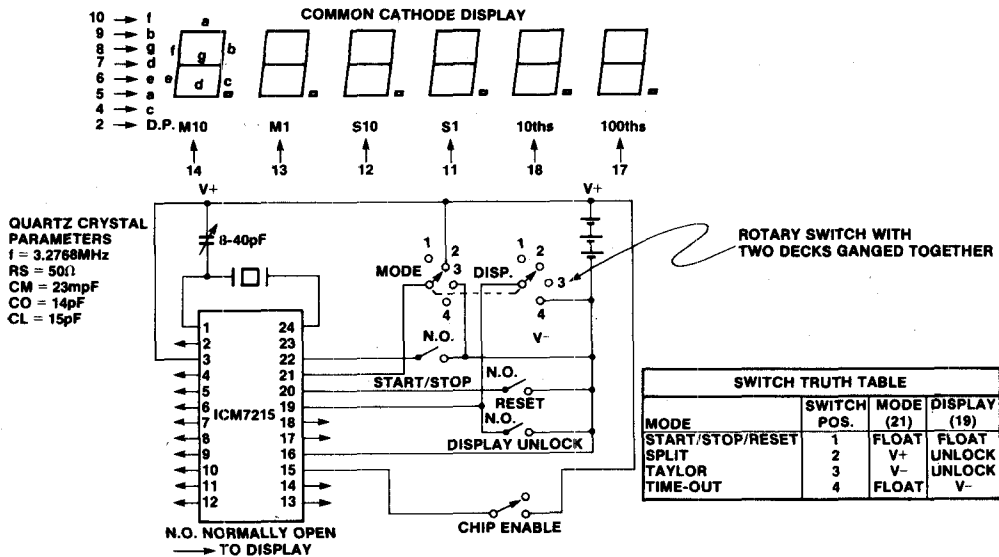

TYPICAL PERFORMANCE CHARACTERISTICS

SUPPLY CURRENT VS VOLTAGE

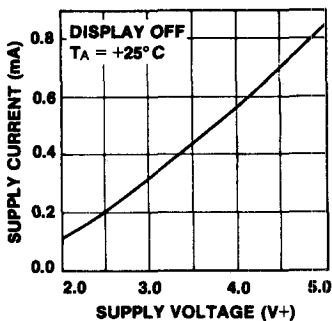

SEGMENT CURRENT VS SUPPLY VOLTAGE

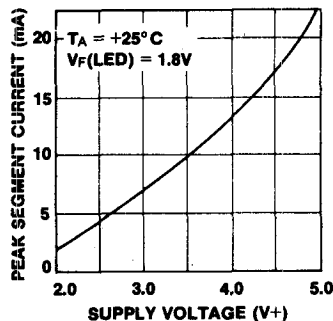

OSC. STABILITY VS SUPPLY VOLTAGE

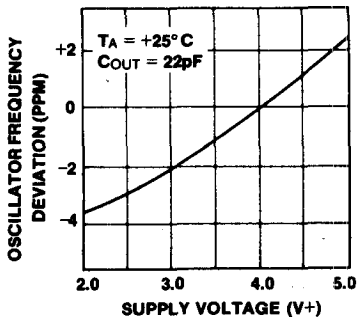

LOW BATTERY INDICATOR (LBI) TRIGGER VOLTAGE VS TEMPERATURE

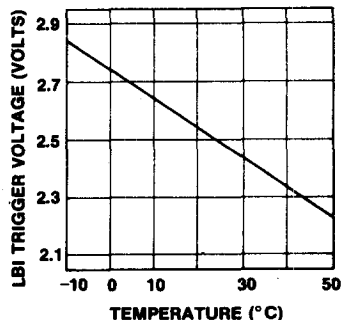

7

FUNCTIONAL OPERATION

Turning on the stopwatch will bring up the reset state with the fractional seconds displaying 00 and the other digits blanked. This display always indicates that the stopwatch is ready to go.

The display can be turned off in any mode by connecting the chip enable input to V+.

START/STOP/RESET MODE

When the mode input is floating and the display input is floating or connected to V+ the circuit is in the start/stop/reset mode.

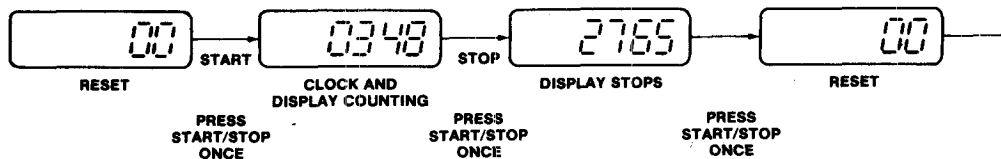

The start/stop/reset mode can be used for single event timing in a one-button stopwatch; an additional switch can be used to provide an instant reset. To time another event, the display must be reset before the start of the event. Seconds will be displayed after one second, minutes after

one minute. The range of the stopwatch is 59 minutes 59.99 seconds, and if an event exceeds one hour, the number of hours must be remembered by the user. Leading zeroes are not blanked after one hour.

TAYLOR OR SEQUENTIAL MODE

When the mode input is connected to V-, the stopwatch is in the taylor or sequential mode.

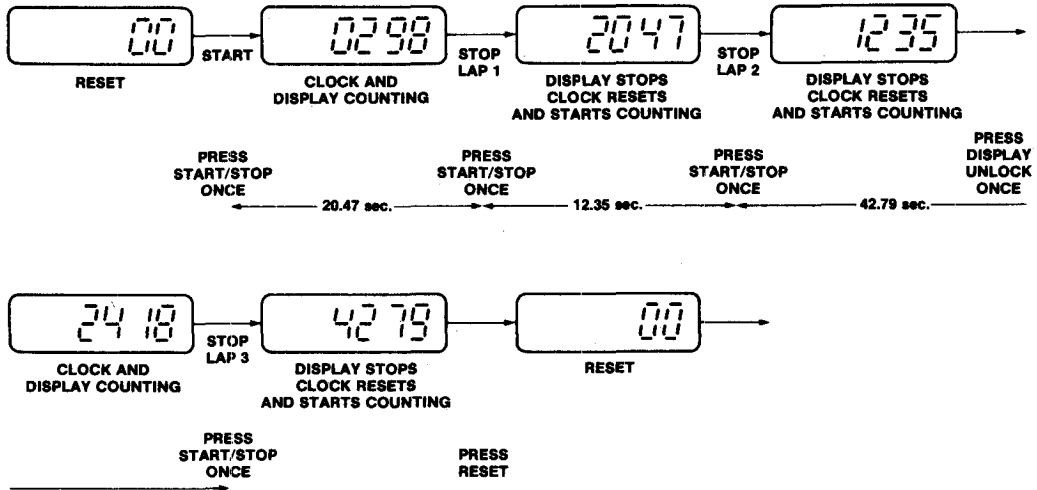

Each split time is measured from zero in the taylor mode; i.e., after stopping the watch, the counters reset momentarily and start counting the next interval. The time displayed is that elapsed since the last activation of start/stop. The display is

stationary after the first interval unless the display unlock is used to show the running clock. Reset can be used at any time.

SPLIT MODE

When the mode input is connected to V+ the stopwatch is in the split mode.

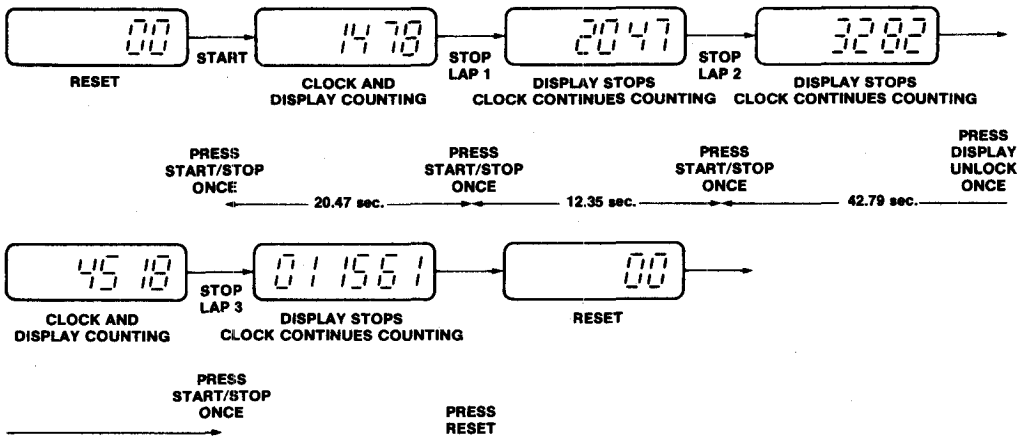

The split mode differs from the taylor in that the lap times are cumulative in the split mode. The counters do not reset or stop after the first start until reset is activated. Time

displayed is the cumulative time elapsed since the first start after reset. Display unlock can be used to let the display 'catch up' with the clock, and reset can be used at any time.

TIME OUT MODE

When the mode input is floating and the display input is tied to V-, the stopwatch is in the time-out mode.

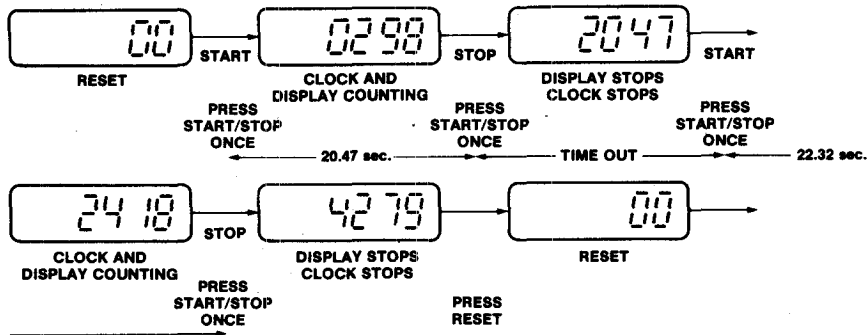

In the time-out mode the clock and display alternately start and stop with activations of the start/stop switch. Reset can

be used at any time. The display unlock button is bypassed in this mode.

APPLICATION NOTES

LOW BATTERY INDICATOR

The on-chip low battery indicator is intended for use with a small LED or the decimal points on a standard LED display. The output is the drain of a p-channel transistor two-thirds the size of the segment drivers, and designed to provide a trigger voltage of approximately 2.5 volts at room temperature. Normal AA type batteries will provide many hours of accurate timekeeping after the indicator comes on, however the wide voltage spread between the LBI voltage and minimum operating voltage is required to guarantee low battery indication under worst case conditions.

7

CHIP ENABLE

The chip enable input is used to disable both segment and digit drivers without affecting any of the functions of the device. When the chip enable input is floating or connected to V-, the display is enabled, and when the tied to V+ the display is turned off. One example of the many possible uses of this feature is driving one display from two ICM7215 devices, one in the split mode and the other in the Taylor mode. The circuit below indicates how the user can obtain lap and cumulative readings of the same event.

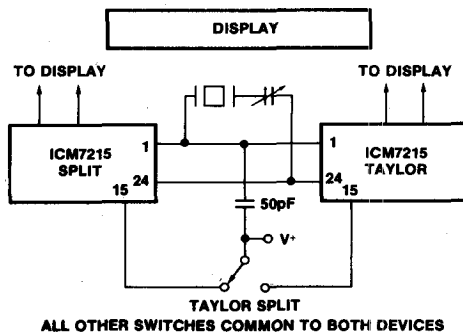

SWITCH CHARACTERISTICS

The ICM7215 is designed for use with SPST switches throughout. On the display unlock and reset inputs the characteristics of the switches are unimportant, since the circuit responds to a logic level held for any length of time however short. Switch bounce on these inputs does not need to be specified. The start/stop input, however, responds to an edge and so requires a switch with less than 15ms of switch bounce. The bounce protection circuitry has been specifically designed to let the circuit respond to the first edge of the signal, so as to preserve the full accuracy of the system.

LATCHUP CONSIDERATIONS

Due to the inherent structure of junction isolated CMOS devices, the circuit can be put in a latchup mode if large currents are injected into device inputs or outputs. For this reason special care should be taken in a system with multiple power supplies to prevent voltages being applied to inputs and/or outputs before power is applied to the 7215. If only inputs are affected, latchup can also be prevented by limiting the current into the input terminal to less than 1mA.

OSCILLATOR DESIGN

The oscillator of the ICM7215 includes all components on chip except the 3.2768 MHz crystal and the trimming capacitor. The oscillator input capacitance has a nominal value of 30pF, and the circuit is designed to work with a crystal with a load capacitance of approximately 15pF. If the crystal has characteristics as shown on page 3, an 8-40pF trimming capacitor will be adequate for a tuning tolerance of ± 30 PPM on the crystal. If the crystal's static capacitance is significantly lower, a narrower trimming range may be selected.

After deciding on a crystal and a nominal load capacitance, take the worst case values of C_{in} , C_{out} and R_s and calculate the g_m required by:

$$g_m = \omega^2 C_{in} C_{out} R_s \left\{ 1 + \frac{C_o (C_{in} + C_{out})}{C_{in} C_{out}} \right\}^2$$

- C_o = static capacitance
- R_s = series resistance
- C_{in} = input capacitance
- C_{out} = output capacitance
- ω = $2\pi \times$ crystal frequency

The resulting g_m should be less than half the g_m specified for the device. If it is not, a lower value of crystal series resistance and/or load capacitance should be specified.

OSCILLATOR TUNING

Tuning can be accomplished by using the 10th or 100th seconds with the device reset. The frequency on the cathode should be tuned to 1066.667 Hz, which is equivalent to a period of 937.5 microseconds. Note that a frequency counter cannot be connected directly to the oscillator because of possible loading.

TEST POINT

The test point input is used for high speed testing of the device. When the input is pulsed low, a latch is set which speeds up counting by a factor of 32; each pulse on the test point rapidly advances both minutes and seconds in a parallel mode. To accurately rapid advance the signal applied to the test point must be free of switch bounce. The circuit is taken out of the test mode by using either reset or start/stop.

REPLACING THE ICM7205 WITH THE ICM7215

The ICM7215 is designed to be compatible with circuits using the ICM7205. If the 7205 is used only in the split mode no changes are required. If the 7205 is used in the Taylor mode and the split Taylor input (pin 21) is left open, a jumper from pin 21 to V^- must be added when converting to the 7215. A jumper may also be needed if the 7205 is used with a split/Taylor switch. Once the jumper has been added the board can be used with either device.

CHIP TOPOGRAPHY

