

## FEATURES

- 3.3V, 5.0V, 12V, 15V, and Adjustable Output Versions
- Adjustable Version Output Voltage Range, 1.23 to 37V  
+/- 4% AG10Maximum Over Line and Load Conditions
- Guaranteed 3.0A Output Current
- Wide Input Voltage Range
- Requires Only 4 External Components
- 52kHz Fixed Frequency Internal Oscillator
- TTL Shutdown Capability, Low Power Standby Mode
- High Efficiency
- Uses Readily Available Standard Inductors
- Thermal Shutdown and Current Limit Protection
- Moisture Sensitivity Level 3

## Applications

- Simple High-Efficiency Step-Down(Buck) Regulator
- Efficient Pre-Regulator for Linear Regulators
- On-Card Switching Regulators
- Positive to Negative Converter(Buck-Boost)
- Negative Step-Up Converters
- Power Supply for Battery Chargers

## DESCRIPTION

The LM2576 series of regulators are monolithic integrated circuits ideally suited for easy and convenient design of a step-down switching regulator(buck converter).

All circuits of this series are capable of driving a 3.0A load with excellent line and load regulation. These devices are available in fixed output voltages of 3.3V, 5.0V,12V, 15V, and an adjustable output version.

These regulators were designed to minimize the number of external components to simplify the power supply design. Standard series of inductors optimized for use with the LM2576 are offered by several different inductor manufacturers.

Since the LM2576 converter is a switch-mode power supply, its efficiency is significantly higher in comparison with popular three-terminal linear regulators, especially with higher input voltages.

In many cases, the power dissipated is so low that no heatsink is required or its size could be reduced dramatically. A standard series of inductors optimized for use with the LM2576 are available from several different manufacturers. This feature greatly simplifies the design of switch-mode power supplies. The LM2576 features include a guaranteed +/- 4% tolerance on output voltage within specified input voltages and output load conditions, and +/-10% on the oscillator frequency (+/- 2% over 0oC to 125 oC).

External shutdown is included, featuring 80  $\mu$ A(typical) standby current. The output switch includes cycle-by-cycle current limiting, as well as thermal shutdown for full protection under fault conditions.

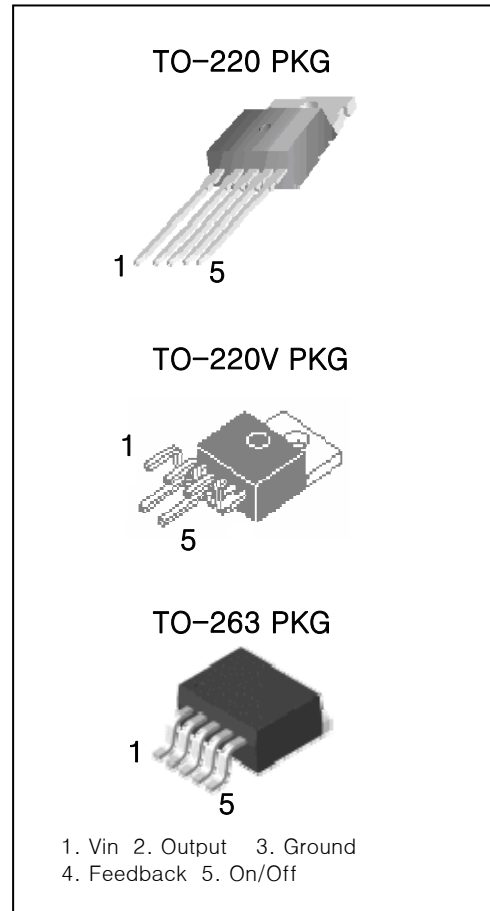

## ORDERING INFORMATION

Device	Marking	Package
LM2576T-X.X	LM2576T-X.X	TO-220
LM2576TV-X.X	LM2576T-X.X	TO-220V
LM2576R	LM2576R-X.X	TO-263

Typical Application (Fixed Output Voltage Versions)

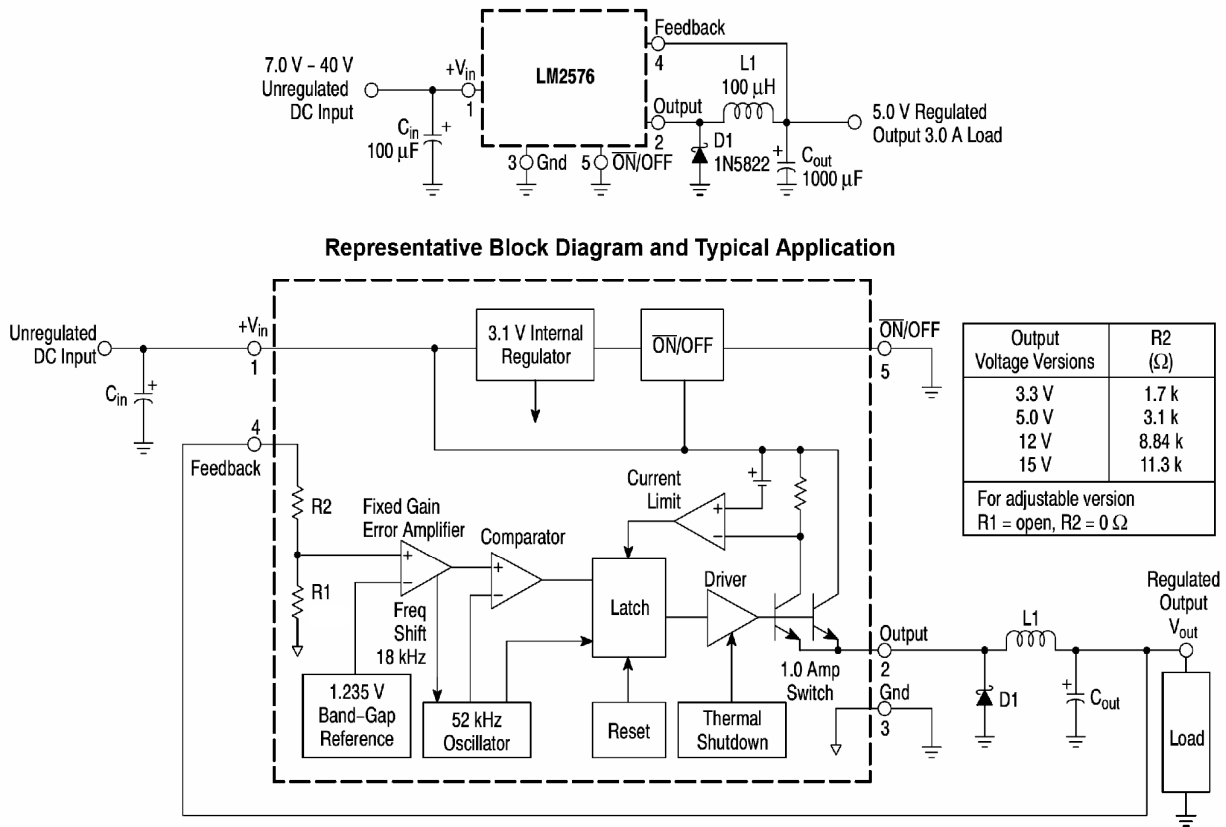

Figure 1. Block Diagram and Typical Application

ABSOLUTE MAXIMUM RATINGS

(Absolute Maximum Ratings indicate limits beyond which damage to the device may occur)

Rating	Symbol	Value	Unit
Maximum Supply Voltage	V <sub>in</sub>	45	V
On/Off Pin Input Voltage	–	-0.3V ≤ V ≤ +V <sub>in</sub>	V
Output Voltage to Ground (Steady-State)	–	- 1.0	V
Power Dissipation			
TO-220 5Lead	P <sub>D</sub>	Internally Limited	W
Thermal Resistance, Junction to Ambient	P <sub>θJA</sub>	65	°C/W
Thermal Resistance, Junction to Case	P <sub>θJC</sub>	5.0	°C/W
TO-263 5Lead	P <sub>D</sub>	Internally Limited	W
Thermal Resistance, Junction to Ambient	P <sub>θJA</sub>	70	°C/W
Thermal Resistance, Junction to Case	P <sub>θJC</sub>	5.0	°C/W
Storage Temperature Range	T <sub>stg</sub>	-60 to +150	°C
Minimum ESD Rating(Human Body Model : C=100 pF, R=1.5kΩ)	–	2.0	kV
Lead Temperature (Soldering,10seconds)	–	260	°C
Maximum Junction Temperature	T <sub>J</sub>	150	°C

### 3.0A, 52kHz, Step-Down Switching Regulator

**LM2576**

**OPERATING RATINGS**(Operating Ratings indicate conditions for which the device is intended to be functional, but do not guarantee specific performance limits. For guaranteed specifications, see the Electrical Characteristics.)

Rating	Symbol	Value	Unit
Operating Junction Temperature Range	T <sub>J</sub>	-40 to +125	°C
Supply Voltage	V <sub>in</sub>	40	V

**ELECTRICAL CHARACTERISTICS** / SYSTEM PARAMETERS ([Note 1] Test Circuit Figure 15)  
 (Unless otherwise specified, V<sub>in</sub> = 12 V for the 3.3 V, 5.0 V, and Adjustable version, V<sub>in</sub> = 25 V for the 12 V version, and V<sub>in</sub> = 30 V for the 15 V version. I<sub>LOAD</sub> = 500 mA. For typical values T<sub>J</sub> = 25°C, for min/max values T<sub>J</sub> is the operating junction temperature range that applies [Note 2], unless otherwise noted.)

Characteristics	Symbol	Min	TYP	Max	Unit
<b>LM2576-3.3V ([Note 1] Test Circuit Figure 2)</b>					
Output Voltage (V <sub>in</sub> = 12V, I <sub>LOAD</sub> =0.5A, T <sub>J</sub> =25°C)	V <sub>out</sub>	3.234	3.3	3.366	V
Output Voltage (6.0V ≤ V <sub>in</sub> ≤ 40V, 0.5A ≤ I <sub>LOAD</sub> ≤ 3.0A T <sub>J</sub> =25°C T <sub>J</sub> = -40°C ~ +125°C)	V <sub>out</sub>	3.168 3.135	3.3 -	3.432 3.465	V
Efficiency (V <sub>in</sub> =12V, I <sub>LOAD</sub> =3.0A)	η	-	75	-	%

<b>LM2576-5.0V ([Note 1] Test Circuit Figure 2)</b>					
Output Voltage (V <sub>in</sub> = 12V, I <sub>LOAD</sub> =0.5A, T <sub>J</sub> =25°C)	V <sub>out</sub>	4.9	5.0	5.1	V
Output Voltage (8.0V ≤ V <sub>in</sub> ≤ 40V, 0.5A ≤ I <sub>LOAD</sub> ≤ 3.0A T <sub>J</sub> =25°C T <sub>J</sub> = -40°C ~ +125°C)	V <sub>out</sub>	4.8 4.75	5.0 -	5.2 5.25	V
Efficiency (V <sub>in</sub> =12V, I <sub>LOAD</sub> =3.0A)	η	-	77	-	%

<b>LM2576-12V ([Note 1] Test Circuit Figure 2)</b>					
Output Voltage (V <sub>in</sub> = 25V, I <sub>LOAD</sub> =0.5A, T <sub>J</sub> =25°C)	V <sub>out</sub>	11.76	12	12.24	V
Output Voltage (15V ≤ V <sub>in</sub> ≤ 40V, 0.5A ≤ I <sub>LOAD</sub> ≤ 3.0A T <sub>J</sub> =25°C T <sub>J</sub> = -40°C ~ +125°C)	V <sub>out</sub>	11.52 11.4	12 -	12.48 12.6	V
Efficiency (V <sub>in</sub> =25V, I <sub>LOAD</sub> =3.0A)	η	-	88	-	%

<b>LM2576-ADJ ([Note 1] Test Circuit Figure 2)</b>					
Feedback Voltage (V <sub>in</sub> =12V, I <sub>LOAD</sub> =0.5A, T <sub>J</sub> =25°C)	V <sub>out</sub>	1.217	1.23	1.243	V
Feedback Voltage(8.0V ≤ V <sub>in</sub> ≤ 40V, 0.5A ≤ I <sub>LOAD</sub> ≤ 3.0A, V <sub>out</sub> =5.0V) T <sub>J</sub> =25°C T <sub>J</sub> = -40°C ~ +125°C)	V <sub>out</sub>	1.193 1.18	1.23 -	1.267 1.28	V
Efficiency (V <sub>in</sub> =12V, I <sub>LOAD</sub> =3.0A, V <sub>out</sub> =5.0V)	η	-	77	-	%

1. External components such as the catch diode, inductor, input and output capacitors can affect switching regulator system performance.

When the LM2576 is used as shown in the Figure 15 test circuit, system performance will be as shown in system parameters section .

2. Tested junction temperature range for the LM2576: T<sub>low</sub> = -40°C T<sub>high</sub> = +125°C

#### ELECTRICAL CHARACTERISTICS / Device Parameters

(Unless otherwise specified,  $V_{in} = 12\text{ V}$  for the 3.3 V, 5.0 V, and Adjustable version,  $V_{in} = 25\text{ V}$  for the 12 V version, and  $V_{in} = 30\text{ V}$  for the 15 V version.  $I_{Load} = 500\text{ mA}$ . For typical values  $T_J = 25^\circ\text{C}$ , for min/max values  $T_J$  is the operating junction temperature range that applies [Note 2], unless otherwise noted.)

Characteristics	Symbol	Min	TYP	Max	Unit
<b>All Output Voltage Versions</b>					
Feedback Bias Current ( $V_{out}=5.0\text{V}$ [Adjustable Version Only]) $T_J=25^\circ\text{C}$ $T_J= -40\text{ to }+125^\circ\text{C}$	$I_b$	– –	25 –	100 200	nA
Oscillator Frequency [Note 3] $T_J=25^\circ\text{C}$ $T_J= 0\text{ to }+125^\circ\text{C}$ $T_J= -40\text{ to }+125^\circ\text{C}$	$F_{osc}$	– 47 42	52 – –	– 58 63	kHz
Saturation Voltage ( $I_{out}=3.0\text{A}$ [note 4]) $T_J=25^\circ\text{C}$ $T_J= -40\text{ to }+125^\circ\text{C}$	$V_{sat}$	– –	1.5 –	1.8 2	V
Max Duty Cycle ("0") [Note 5]	DC	94	98	–	%
Current Limit (Peak Current [Note 3 and 4]) $T_J=25^\circ\text{C}$ $T_J= -40\text{ to }+125^\circ\text{C}$	$I_{CL}$	4.2 3.5	5.8 –	6.9 7.5	A
Output Leakage Current [Note 6 and 7], $T_J=25^\circ\text{C}$ Output = 0V Output = -1.0V	$I_L$	– –	0.8 6	50 30	mA
Quiescent Current [Note 6] $T_J=25^\circ\text{C}$ $T_J= -40\text{ to }+125^\circ\text{C}$	$I_Q$	– –	5 –	9 11	mA
Standby Quiescent Current (ON/OFF Pin = 5.0V ("off")) $T_J=25^\circ\text{C}$ $T_J= -40\text{ to }+125^\circ\text{C}$	$I_{STBY}$	– –	80 –	200 400	$\mu\text{A}$
ON/OFF Pin Logic Input Level (Test circuit Figure 15) $V_{out}=0\text{V}$ $T_J=25^\circ\text{C}$ $T_J= -40\text{ to }+125^\circ\text{C}$	$V_{IH}$	2.2 2.4	1.4 –	– –	V
$V_{out}=\text{Nominal Output Voltage}$ $T_J=25^\circ\text{C}$ $T_J= -40\text{ to }+125^\circ\text{C}$	$V_{IL}$	– –	1.2 –	1 0.8	V
ON/OFF Pin Input Current (Test Circuit Figure 15) ON/OFF Pin = 5.0V (Regulator OFF), $T_J=25^\circ\text{C}$ ON/OFF Pin = 0V (Regulator ON), $T_J=25^\circ\text{C}$	$I_{IH}$ $I_{IL}$	– –	15 0	30 5.0	$\mu\text{A}$

3. The oscillator frequency reduces to approximately 18 kHz in the event of an output short or an overload which causes the regulated output voltage to drop approximately 40% from the nominal output voltage. This self protection

feature lowers the average dissipation of the IC by lowering the minimum duty cycle from 5% down to approximately 2%.

4. Output (Pin 2) sourcing current. No diode, inductor or capacitor connected to output pin.

5. Feedback (Pin 4) removed from output and connected to 0 V.

6. Feedback (Pin 4) removed from output and connected to +12 V for the Adjustable, 3.3 V, and 5.0V versions, and +25 V for the 12 V and 15 V versions, to force the output transistor "off".

7.  $V_{in} = 40\text{ V}$ .

TYPICAL PERFORMANCE CHARACTERISTICS (Circuit of Figure 15)

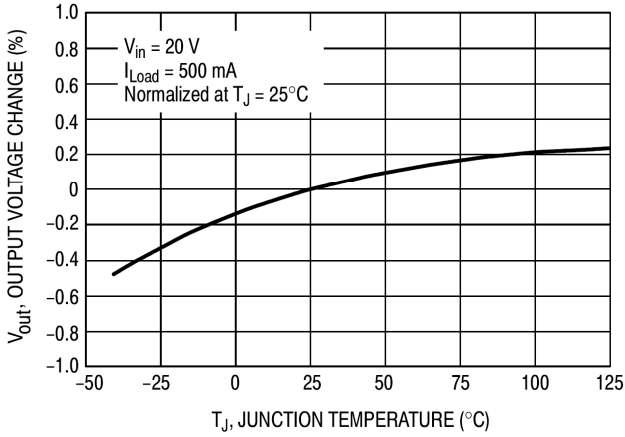

Figure 2. Normalized Output Voltage

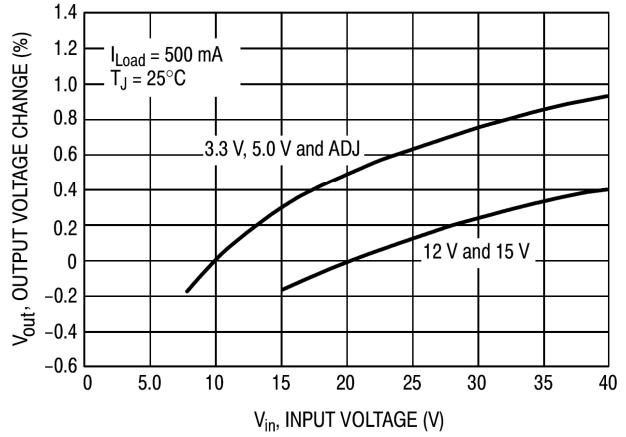

Figure 3. Line Regulation

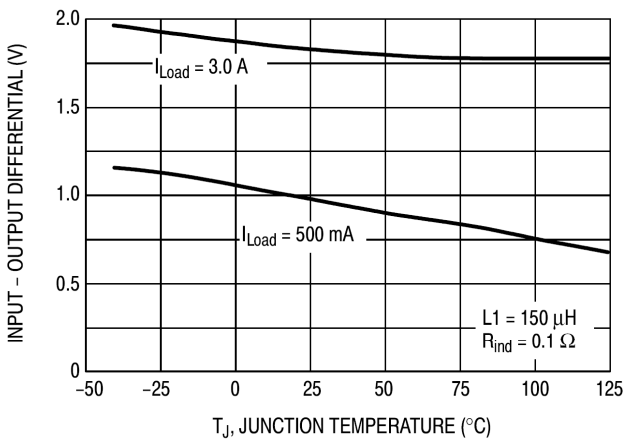

Figure 4. Dropout Voltage

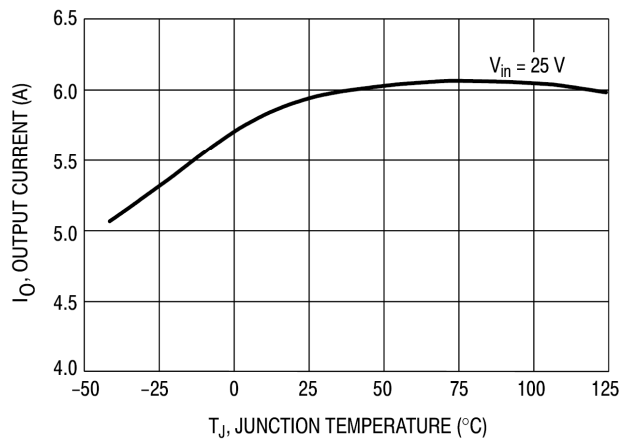

Figure 5. Current Limit

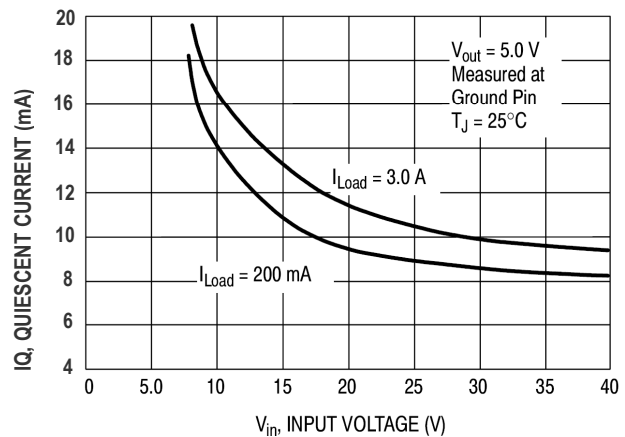

Figure 6. Quiescent Current

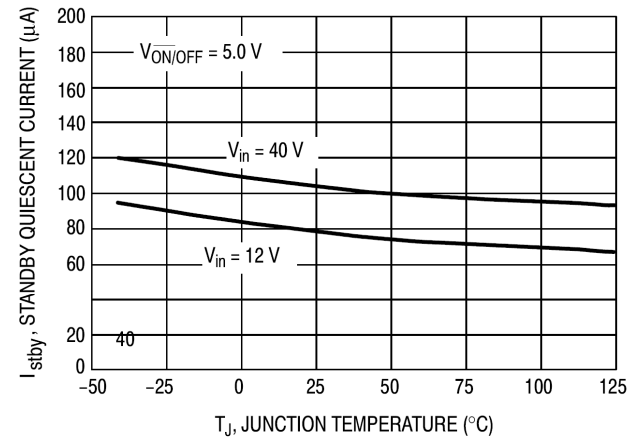

Figure 7. Standby Quiescent Current

TYPICAL PERFORMANCE CHARACTERISTICS (Circuit of Figure 15)

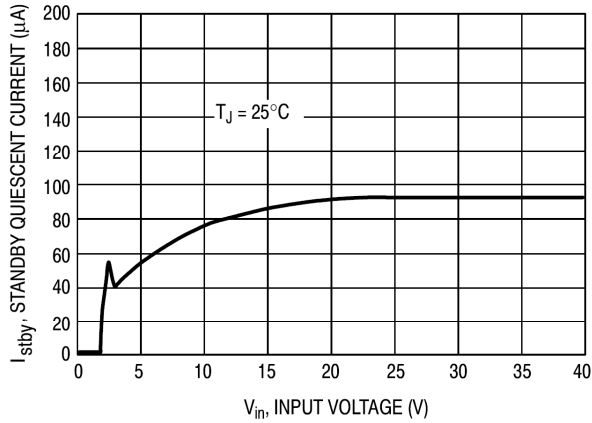

Figure 8. Standby Quiescent Current

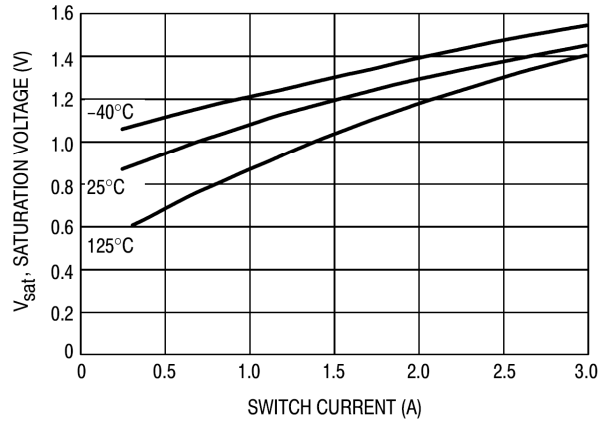

Figure 9. Switch Saturation Voltage

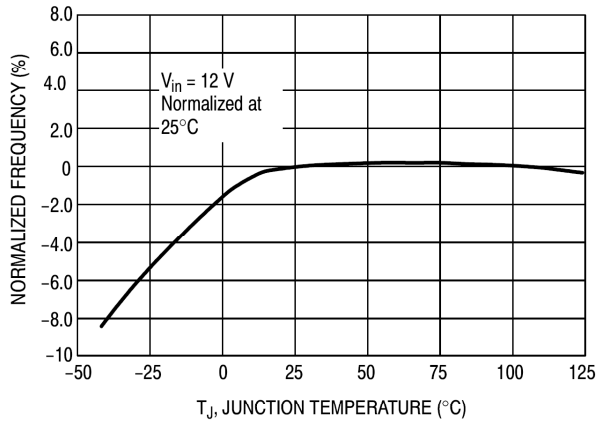

Figure 10. Oscillator Frequency

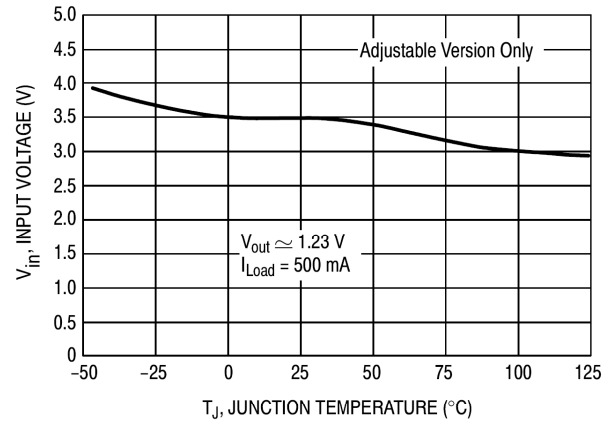

Figure 11. Minimum Operating Voltage

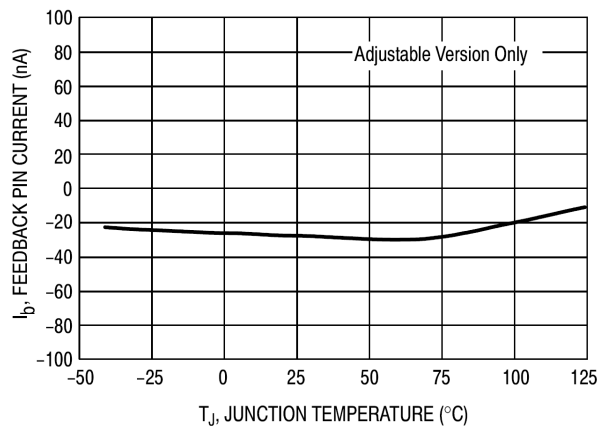

Figure 12. Feedback Pin Current

TYPICAL PERFORMANCE CHARACTERISTICS

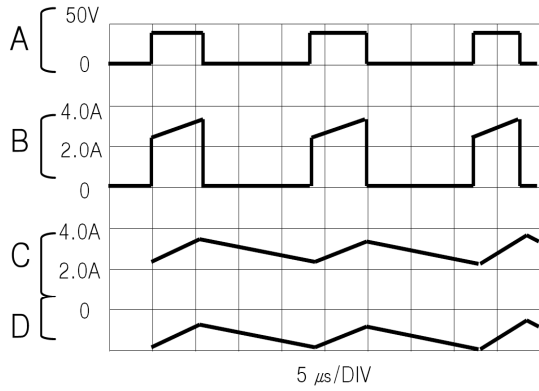

Figure 13. Switching Waveforms

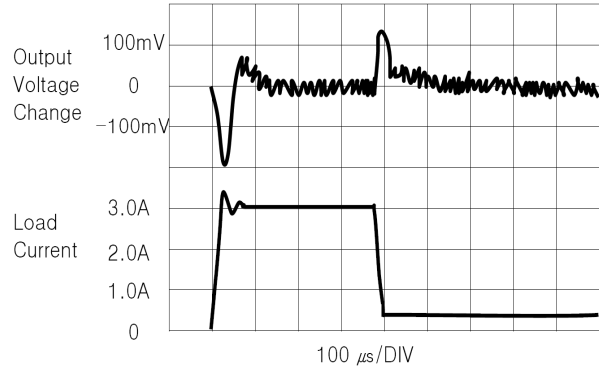

Figure 14. Load Transient Response

Vout = 15V

A : Output Pin Voltage, 10V/DIV

B : Inductor Current, 2.0A/DIV

C : Inductor Current, 2.0A/DIV

D : Output Ripple Voltage, 50mV/dDIV, AC-Coupled

Horizontal Time Base : 5.0 μs/DIV

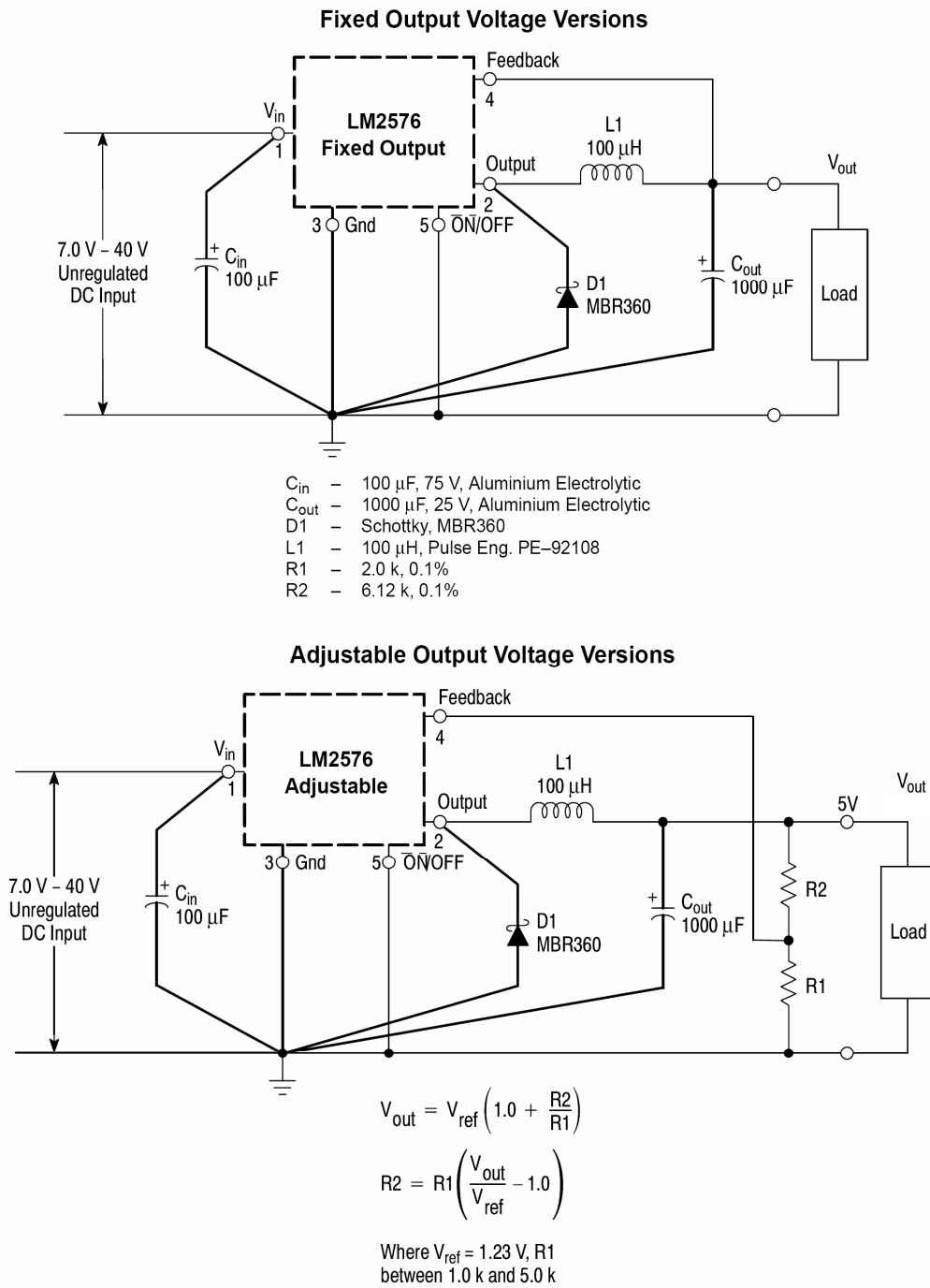

< Figure 15. Typical Test Circuit >



## PIN FUNCTION DESCRIPTION

	Symbol	Description
1	$V_{in}$	This pin is the positive input supply for the LM2576 step-down switching regulator. In order to minimize voltage transients and to supply the switching currents needed by the regulator, a suitable input bypass capacitor must be present. ( $C_{in}$ in Figure 1).
2	Output	This is the emitter of the internal switch. The saturation voltage $V_{sat}$ of this output switch is typically 1.5 V. It should be kept in mind that the PCB area connected to this pin should be kept to a minimum in order to minimize coupling to sensitive circuitry.
3	Gnd	Circuit ground pin. See the information about the printed circuit board layout.
4	Feedback	This pin senses regulated output voltage to complete the feedback loop. The signal is divided by the internal resistor divider network R2, R1 and applied to the non-inverting input of the internal error amplifier. In the Adjustable version of the LM2576 switching regulator this pin is the direct input of the error amplifier and the resistor network R2, R1 is connected externally to allow programming of the output voltage.
5	ON/OFF	It allows the switching regulator circuit to be shut down using logic level signals, thus dropping the total input supply current to approximately 80 mA. The threshold voltage is typically 1.4 V. Applying a voltage above this value (up to $+V_{in}$ ) shuts the regulator off. If the voltage applied to this pin is lower than 1.4V or if this pin is left open, the regulator will be in the "on" condition

**Procedure (Fixed Output Voltage Version)** In order to simplify the switching regulator design, a step-by-step design procedure and some examples are provided.

Procedure	Example
<p><b>Given Parameters:</b>  <math>V_{out}</math> = Regulated Output Voltage (3.3 V, 5.0 V, 12 V or 15 V)  <math>V_{in(max)}</math> = Maximum Input Voltage  <math>I_{Load(max)}</math> = Maximum Load Current</p>	<p><b>Given Parameters:</b>  <math>V_{out}</math> = 5.0 V  <math>V_{in(max)}</math> = 15 V  <math>I_{Load(max)}</math> = 3.0 A</p>
<p><b>1. Controller IC Selection</b>            According to the required input voltage, output voltage and current, select the appropriate type of the controller IC output voltage version.</p>	<p><b>1. Controller IC Selection</b>            According to the required input voltage, output voltage, current polarity and current value, use the LM2576-5 controller IC</p>
<p><b>2. Input Capacitor Selection (<math>C_{in}</math>)</b>            To prevent large voltage transients from appearing at the input and for stable operation of the converter, an aluminium or tantalum electrolytic bypass capacitor is needed between the input pin +<math>V_{in}</math> and ground pin GND. This capacitor should be located close to the IC using short leads. This capacitor should have a low ESR (Equivalent Series Resistance) value.</p>	<p><b>2. Input Capacitor Selection (<math>C_{in}</math>)</b>            A 100 <math>\mu</math>F, 25 V aluminium electrolytic capacitor located near to the input and ground pins provides sufficient bypassing.</p>
<p><b>3. Catch Diode Selection (D1)</b>  <b>A.</b> Since the diode maximum peak current exceeds the regulator maximum load current the catch diode current rating must be at least 1.2 times greater than the maximum load current. For a robust design the diode should have a current rating equal to the maximum current limit of the LM2576 to be able to withstand a continuous output short  <b>B.</b> The reverse voltage rating of the diode should be at least 1.25 times the maximum input voltage.</p>	<p><b>3. Catch Diode Selection (D1)</b>  <b>A.</b> For this example the current rating of the diode is 3.0 A.   <b>B.</b> Use a 20 V 1N5820 Schottky diode, or any of the suggested fast recovery diodes</p>
<p><b>4. Inductor Selection (L1)</b>  <b>A.</b> According to the required working conditions, select the correct inductor value using the selection guide from   <b>B.</b> From the appropriate inductor selection guide, identify the inductance region intersected by the Maximum Input Voltage line and the Maximum Load Current line. Each region is identified by an inductance value and an inductor code.  <b>C.</b> Select an appropriate inductor from the several different manufacturers part numbers            The designer must realize that the inductor current rating must be higher than the maximum peak current flowing through the inductor. This maximum peak current can be calculated as follows:  <math display="block">I_{p(max)} = I_{Load(max)} + \frac{(V_{in} - V_{out}) t_{on}}{2L}</math>           where <math>t_{on}</math> is the "on" time of the power switch and  <math display="block">t_{on} = \frac{V_{out}}{V_{in}} \times \frac{1.0}{f_{osc}}</math>            For additional information about the inductor, see the inductor section in the "Application Hints" section of this data sheet.</p>	<p><b>4. Inductor Selection (L1)</b>  <b>A.</b> From the selection guide, the inductance area intersected by the 15 V line and 3.0 A line is L100.   <b>B.</b> Inductor value required is 100 <math>\mu</math>H. choose an inductor from any of the listed manufacturers.</p>

**Procedure (Fixed Output Voltage Version) (continued)** In order to simplify the switching regulator design, a step-by-step design procedure and some examples are provided.

Procedure	Example
<p><b>5. Output Capacitor Selection (<math>C_{out}</math>)</b></p> <p>A. Since the LM2576 is a forward-mode switching regulator with voltage mode control, its open loop 2-pole-1-zero frequency characteristic has the dominant pole-pair determined by the output capacitor and inductor values. For stable operation and an acceptable ripple voltage, (approximately 1% of the output voltage) a value between 680 <math>\mu</math>F and 2000 <math>\mu</math>F is recommended.</p> <p>B. Due to the fact that the higher voltage electrolytic capacitors generally have lower ESR (Equivalent Series Resistance) numbers, the output capacitor's voltage rating should be at least 1.5 times greater than the output voltage. For a 5.0 V regulator, a rating at least 8.0 V is appropriate, and a 10 V or 16 V rating is recommended.</p>	<p><b>5. Output Capacitor Selection (<math>C_{out}</math>)</b></p> <p>A. <math>C_{out}</math> = 680 <math>\mu</math>F to 2000 <math>\mu</math>F standard aluminium electrolytic.</p> <p>B. Capacitor voltage rating = 20 V.</p>

**Procedure (Adjustable Output Version: LM2576-ADJ)**

Procedure	Example
<p><b>Given Parameters:</b></p> <p><math>V_{out}</math> = Regulated Output Voltage  <math>V_{in(max)}</math> = Maximum DC Input Voltage  <math>I_{Load(max)}</math> = Maximum Load Current</p>	<p><b>Given Parameters:</b></p> <p><math>V_{out}</math> = 8.0 V  <math>V_{in(max)}</math> = 25 V  <math>I_{Load(max)}</math> = 2.5 A</p>
<p><b>1. Programming Output Voltage</b>            To select the right programming resistor R1 and R2 value use the following formula:</p> $V_{out} = V_{ref} \left( 1.0 + \frac{R2}{R1} \right) \text{ where } V_{ref} = 1.23 \text{ V}$ <p>Resistor R1 can be between 1.0 k and 5.0 k<math>\Omega</math>. (For best temperature coefficient and stability with time, use 1% metal film resistors).</p> $R2 = R1 \left( \frac{V_{out}}{V_{ref}} - 1.0 \right)$	<p><b>1. Programming Output Voltage (selecting R1 and R2)</b>            Select R1 and R2:</p> $V_{out} = 1.23 \left( 1.0 + \frac{R2}{R1} \right) \text{ Select } R1 = 1.8 \text{ k}\Omega$ $R2 = R1 \left( \frac{V_{out}}{V_{ref}} - 1.0 \right) = 1.8 \text{ k} \left( \frac{8.0 \text{ V}}{1.23 \text{ V}} - 1.0 \right)$ <p>R2 = 9.91 k<math>\Omega</math>, choose a 9.88 k metal film resistor.</p>
<p><b>2. Input Capacitor Selection (<math>C_{in}</math>)</b>            To prevent large voltage transients from appearing at the input and for stable operation of the converter, an aluminium or tantalum electrolytic bypass capacitor is needed between the input pin +<math>V_{in}</math> and ground pin GND. This capacitor should be located close to the IC using short leads. This capacitor should have a low ESR (Equivalent Series Resistance) value.</p> <p>For additional information see input capacitor section in the "Application Hints" section of this data sheet.</p>	<p><b>2. Input Capacitor Selection (<math>C_{in}</math>)</b>            A 100 <math>\mu</math>F, 150 V aluminium electrolytic capacitor located near the input and ground pin provides sufficient bypassing.</p>
<p><b>3. Catch Diode Selection (D1)</b></p> <p>A. Since the diode maximum peak current exceeds the regulator maximum load current the catch diode current rating must be at least 1.2 times greater than the maximum load current. For a robust design, the diode should have a current rating equal to the maximum current limit of the LM2576 to be able to withstand a continuous output short.</p> <p>B. The reverse voltage rating of the diode should be at least 1.25 times the maximum input voltage.</p>	<p><b>3. Catch Diode Selection (D1)</b></p> <p>A. For this example, a 3.0 A current rating is adequate.</p> <p>B. Use a 30 V 1N5821 Schottky diode or any suggested fast recovery diode</p>

Procedure (Adjustable Output Version: LM2576-ADJ) (continued)

Procedure	Example
<p><b>4. Inductor Selection (L1)</b></p> <p>A. Use the following formula to calculate the inductor Volt x microsecond [V x μs] constant:</p> $E \times T = (V_{in} - V_{out}) \frac{V_{out}}{V_{in}} \times \frac{10^6}{F[\text{Hz}]} \text{ [V x } \mu\text{s]}$ <p>B. Match the calculated E x T value with the corresponding number on the vertical axis. This E x T constant is a measure of the energy handling capability of an inductor and is dependent upon the type of core, the core area, the number of turns, and the duty cycle.</p> <p>C. Next step is to identify the inductance region intersected by the E x T value and the maximum load current value on the horizontal axis.</p> <p>D. From the inductor code, identify the inductor value. Then select an appropriate inductor. The inductor chosen must be rated for a switching frequency of 52 kHz and for a current rating of 1.15 x I<sub>Load</sub>. The inductor current rating can also be determined by calculating the inductor peak current:</p> $I_{p(\text{max})} = I_{\text{Load}(\text{max})} + \frac{(V_{in} - V_{out}) t_{\text{on}}}{2L}$ <p>where t<sub>on</sub> is the "on" time of the power switch and</p> $t_{\text{on}} = \frac{V_{out}}{V_{in}} \times \frac{1.0}{f_{\text{osc}}}$ <p>For additional information about the inductor, see the inductor section in the "External Components" section of this data sheet.</p>	<p><b>4. Inductor Selection (L1)</b></p> <p>A. Calculate E x T [V x μs] constant:</p> $E \times T = (25 - 8.0) \times \frac{8.0}{25} \times \frac{1000}{52} = 80 \text{ [V x } \mu\text{s]}$ <p>B. E x T = 80 [V x μs]</p> <p>C. I<sub>Load(max)</sub> = 2.5 A Inductance Region = H150</p> <p>D. Proper inductor value = 150 μH Choose the inductor from Table 2.</p>
<p><b>5. Output Capacitor Selection (C<sub>out</sub>)</b></p> <p>A. Since the LM2576 is a forward-mode switching regulator with voltage mode control, its open loop 2-pole-1-zero frequency characteristic has the dominant pole-pair determined by the output capacitor and inductor values.</p> <p>For stable operation, the capacitor must satisfy the following requirement:</p> $C_{out} \geq 13,300 \frac{V_{in(\text{max})}}{V_{out} \times L [\mu\text{H}]} \text{ [}\mu\text{F]}$ <p>B. Capacitor values between 10 μF and 2000 μF will satisfy the loop requirements for stable operation. To achieve an acceptable output ripple voltage and transient response, the output capacitor may need to be several times larger than the above formula yields.</p> <p>C. Due to the fact that the higher voltage electrolytic capacitors generally have lower ESR (Equivalent Series Resistance) numbers, the output capacitor's voltage rating should be at least 1.5 times greater than the output voltage. For a 5.0 V regulator, a rating of at least 8.0 V is appropriate, and a 10 V or 16 V rating is recommended.</p>	<p><b>5. Output Capacitor Selection (C<sub>out</sub>)</b></p> <p>A.</p> $C_{out} \geq 13,300 \times \frac{25}{8 \times 150} = 332.5 \mu\text{F}$ <p>To achieve an acceptable ripple voltage, select C<sub>out</sub> = 680 μF electrolytic capacitor.</p>

LM2576 Series Buck Regulator Design Procedures (continued)

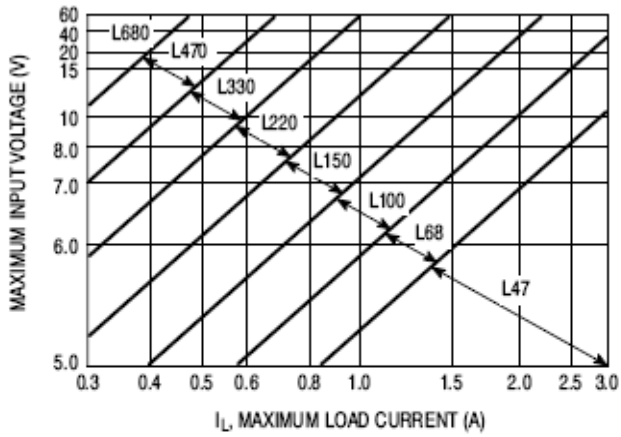

LM2576-3.3

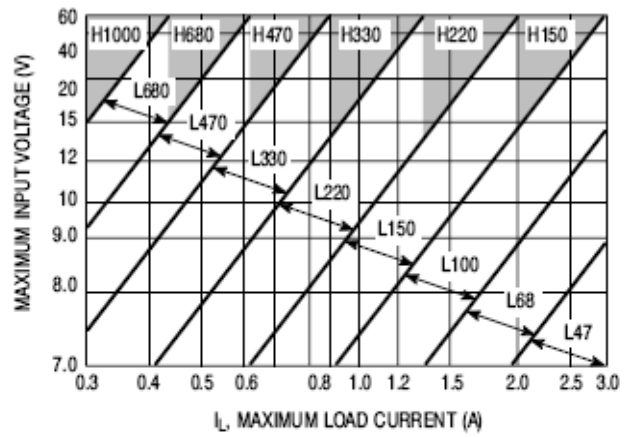

LM2576-5

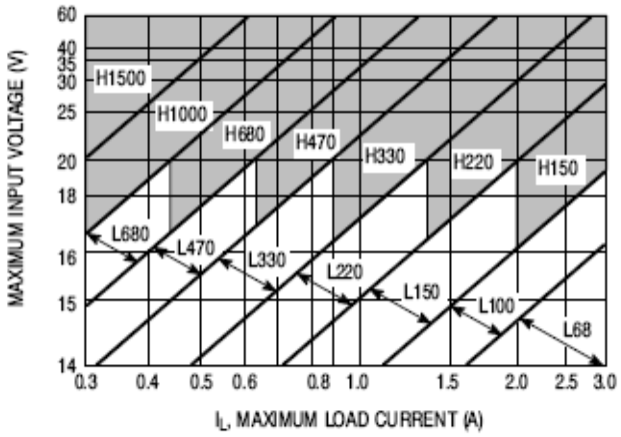

LM2576-12

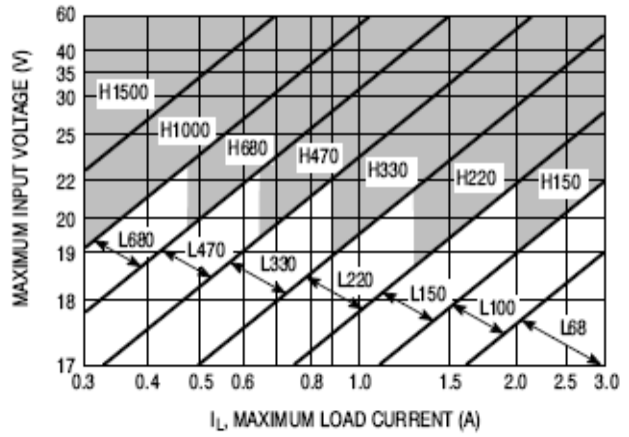

LM2576-15

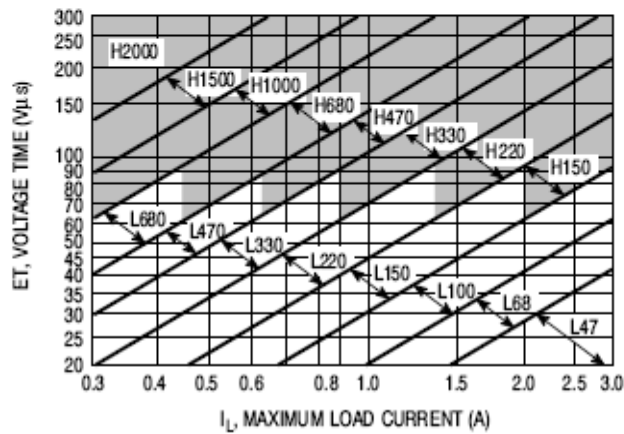

LM2576-ADJ

Table 1. Diode Selection Guide

V <sub>R</sub>	Schottky				Fast Recovery			
	3.0 A		4.0 – 6.0 A		3.0 A		4.0 – 6.0 A	
	Through Hole	Surface Mount	Through Hole	Surface Mount	Through Hole	Surface Mount	Through Hole	Surface Mount
20 V	<b>1N5820</b> MBR320P SR302	SK32	<b>1N5823</b> SR502 SB520		MUR320 31DF1 HER302  (all diodes rated to at least 100 V)	MURS320T3 MURD320 30WF10  (all diodes rated to at least 100 V)	MUR420 HER602  (all diodes rated to at least 100 V)	MURD620CT 50WF10  (all diodes rated to at least 100 V)
30 V	<b>1N5821</b> MBR330 SR303 31DQ03	SK33 30WQ03	<b>1N5824</b> SR503 SB530	50WQ03				
40 V	<b>1N5822</b> MBR340 SR304 31DQ04	SK34 30WQ04 <b>MBRS340T3</b> <b>MBRD340</b>	<b>1N5825</b> SR504 SB540	<b>MBRD640CT</b> 50WQ04				
50 V	MBR350 31DQ05 SR305	SK35 30WQ05	SB550	50WQ05				
60 V	<b>MBR360</b> DQ06 SR306	<b>MBRS360T3</b> <b>MBRD360</b>	50SQ060	<b>MBRD660CT</b>				

NOTE: Diodes listed in bold are available from ON Semiconductor.

Table 2. Inductor Selection by Manufacturer's Part Number

Inductor Code	Inductor Value	Tech 39	Schott Corp.	Pulse Eng.	Renco
L47	47 µH	77 212	671 26980	PE-53112	RL2442
L68	68 µH	77 262	671 26990	PE-92114	RL2443
L100	100 µH	77 312	671 27000	PE-92108	RL2444
L150	150 µH	77 360	671 27010	PE-53113	RL1954
L220	220 µH	77 408	671 27020	PE-52626	RL1953
L330	330 µH	77 466	671 27030	PE-52627	RL1952
L470	470 µH	*	671 27040	PE-53114	RL1951
L680	680 µH	77 506	671 27050	PE-52629	RL1950
H150	150 µH	77 362	671 27060	PE-53115	RL2445
H220	220 µH	77 412	671 27070	PE-53116	RL2446
H330	330 µH	77 462	671 27080	PE-53117	RL2447
H470	470 µH	*	671 27090	PE-53118	RL1961
H680	680 µH	77 506	671 27100	PE-53119	RL1960
H1000	1000 µH	77 556	671 27110	PE-53120	RL1959
H1500	1500 µH	*	671 27120	PE-53121	RL1958
H2200	2200 µH	*	671 27130	PE-53122	RL2448

NOTE: \*Contact Manufacturer