

LM4832 Boomer® Audio Power Amplifier Series

Digitally Controlled Tone and Volume Circuit with Stereo Audio Power Amplifier, Microphone Preamp Stage and National 3D Sound

General Description

The LM4832 is a monolithic integrated circuit that provides volume and tone (bass and treble) controls as well as a stereo audio power amplifier capable of producing 250 mW (typ) into 8Ω or 90 mW (typ) into 32Ω with less than 1.0% THD. In addition, a two input microphone preamp stage, with volume control, capable of driving a 1 kΩ load is implemented on chip.

The LM4832 also features National's 3D Sound circuitry which can be externally adjusted via a simple RC network. For maximum system flexibility, the LM4832 has an externally controlled, low-power consumption shutdown mode, and an independent mute for power and microphone amplifiers.

Boomer® audio integrated circuits were designed specifically to provide high quality audio while requiring few external components. Since the LM4832 incorporates tone and volume controls, a stereo audio power amplifier and a microphone preamp stage, it is optimally suited to multimedia monitors and desktop computer applications.

Key Specifications

■ Output Power at 10% into:	
8Ω	350 mW(typ)
32Ω	100 mW(typ)
■ THD + N at 75 mW into	
32Ω at 1 kHz	0.5%(max)
■ Microphone Input Referred	
Noise	7 μV(typ)
■ Supply Current	13 mA(typ)
■ Shutdown Current	4 μA(max)

Features

- Independent Left and Right Output Volume Controls
- Treble and Bass Control
- National 3D Sound
- I²C Compatible Interface
- Two Microphone Inputs with Selector
- Software Controlled Shutdown Function

Applications

- Multimedia Monitors
- Portable and Desktop Computers

Block Diagram

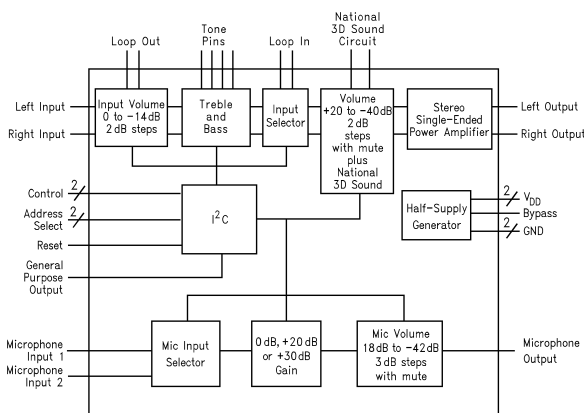
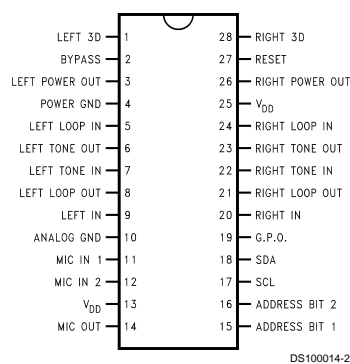

FIGURE 1. LM4832 Block Diagram

Connection Diagram



Top View
Order Number LM4832N, LM4832M
 See NS Package Number N28B for DIP
 See NS Package Number M28B for SOIC

LM4832 Digitally Controlled Tone and Volume Circuit with Stereo Audio Power Amplifier, Microphone Preamp Stage and National 3D Sound

Boomer® is a registered trademark of National Semiconductor Corporation.

Absolute Maximum Ratings (Note 2)

If Military/Aerospace specified devices are required, please contact the National Semiconductor Sales Office/Distributors for availability and specifications.

Supply Voltage	6.0V
Storage Temperature	-65°C to +150°C
Input Voltage	-0.3V to $V_{DD} + 0.3V$
Power Dissipation (Note 3)	Internally limited
ESD Susceptibility (Note 4)	2000V
ESD Susceptibility (Note 5)	250V
Junction Temperature	150°C
Soldering Information	
Small Outline Package	
Vapor Phase (60 sec.)	215°C

Infrared (15 sec.)

220°C

See AN-450 "Surface Mounting and their Effects on Product Reliability" for other methods of soldering surface mount devices.

θ_{JC} (typ)—N28B	21°C/W
θ_{JA} (typ)—N28B	62°C/W
θ_{JC} (typ)—M28B	15°C/W
θ_{JA} (typ)—M28B	69°C/W

Operating Ratings

Temperature Range

$$T_{MIN} \leq T_A \leq T_{MAX}$$

$$-40^\circ\text{C} \leq T_A \leq 85^\circ\text{C}$$

Supply Voltage

$$4.5 \leq V_{DD} \leq 5.5V$$

Electrical Characteristics for Entire IC (Notes 1, 2)

The following specifications apply for $V_{DD} = 5V$ unless otherwise noted. Limits apply for $T_A = 25^\circ\text{C}$.

Symbol	Parameter	Conditions	LM4832		Units (Limits)
			Typical (Note 6)	Limit (Note 7)	
V_{DD}	Supply Voltage	$V_{IN} = 0V, I_O = 0A$		4.5	V (min)
				5.5	V (max)
I_{DD}	Quiescent Power Supply Current		13	21	mA (max)
I_{SD}	Shutdown Current		2.5	9	μA (max)
INPUT ATTENUATORS					
A_R	Attenuator Range	Attenuation at 0 dB Setting Attenuation at -14 dB Setting		1 -15	dB (max) dB (min)
A_S	Step Size	0 dB to -14 dB	2		dB
	Gain Step Size Error		0.1		dB (max)
E_T	Channel to Channel Tracking Error		0.15		dB (max)
BASS CONTROL					
A_R	Bass Control Range	$f = 100\text{ Hz}, V_{IN} = 0.25V$	± 12	-14	dB (min)
				14	dB (max)
A_S	Bass Step Size		2		dB
E_{SE}	Bass Step Size Error		0.5		dB (max)
E_T	Bass Tracking Error		0.15		dB (max)
TREBLE CONTROL					
A_R	Treble Control Range	$f_{IN} = 10\text{ kHz}, V_{IN} = 0.25V$	± 12	-13	dB (min)
				13	dB (max)
A_S	Treble Step Size		2		dB
E_{SE}	Treble Step Size Error		0.1		dB (max)
E_T	Treble Tracking Error		0.15		dB (max)
OUTPUT ATTENUATORS					
A_R	Attenuator Range	Gain at +20 dB Setting Attenuation at -40 dB Setting		21	dB (max)
		+20 dB to -40 dB		-42	dB (min)
A_S	Step Size		2		dB
	Step Size Error		0.1		dB (max)
E_T	Channel to Channel Tracking Error		0.1		dB (max)
AUDIO PATH					
V_{OS}	Output Offset Voltage	$V_{IN} = 0V$	3	50	mV (max)

Electrical Characteristics for Entire IC (Notes 1, 2) (Continued)

The following specifications apply for $V_{DD} = 5V$ unless otherwise noted. Limits apply for $T_A = 25^\circ C$.

Symbol	Parameter	Conditions	LM4832		Units (Limits)
			Typical (Note 6)	Limit (Note 7)	
AUDIO PATH					
P_O	Output Power	THD = 1.0% (max), $f = 1$ kHz, All controls at 0dB			
		$R_L = 8\Omega$	250		mW (min)
		$R_L = 32\Omega$	95	75	mW (min)
THD+N	Total Harmonic Distortion+Noise	All Controls at 0 dB, THD = 10%, $f = 1$ kHz			
		$R_L = 8\Omega$	350		mW
		$P_O = 200$ mW, $R_L = 8\Omega$	0.15		%
		$P_O = 75$ mW, $R_L = 32\Omega$	0.11		%
		$V_O = 1$ Vrms, $R_L = 10\Omega$	0.08		%
PSRR	Power Supply Rejection Ratio	$C_B = 1 \mu F$, $f = 100$ Hz, $V_{RIPPLE} = 100$ mVrms, All Controls at 0 dB Setting	45		dB
A_M	Mute Attenuation	$f = 1$ kHz, $V_{IN} = 1V$	-75		dB
X_{TALK}	Cross Talk	$P_O = 200$ mW, $R_L = 8\Omega$, All controls at 0 dB setting, $f = 1$ kHz			
		Left to Right	-85		dB
		Right to Left	-72		dB
MICROPHONE PREAMP AND VOLUME CONTROL					
A_V	Preamp Gain	0 dB Gain	0	-1, 1	dB
		+20 dB Gain	20	19, 21	dB
		+30 dB Gain	30	29, 31	dB
A_R	Attenuator Range	Gain at +18 dB Setting		20	dB (max)
		Attenuation at -42 dB Setting		-43	dB (min)
A_S	Step Size	0 dB to -42 dB	3		dB
	Step Size Error		0.4		dB (max)
V_{SWING}	Output Voltage Swing	$f = 1$ kHz, THD < 1.0%, $R_L = 1$ k Ω	1.7		V _{rms}
E_{NO}	Input Referred Noise	A-Weighted, Attenuator at 0 dB	7		μV (min)
PSRR	Power Supply Rejection Ratio	$f = 100$ Hz, $V_{RIPPLE} = 100$ mVrms, $C_B = 1 \mu F$	35		dB
A_M	Mute Attenuation		-90		dB
X_{TALK}	Cross Talk	Power Amp $P_O = 200$ mW, $f = 1$ kHz	-90		dB
THD+N	Total Harmonic Distortion Plus Noise	All controls at 0 dB, $f = 1$ kHz, $V_O = 1V$			
		0 dB Setting	0.03		%
		+20 dB Gain	0.03		%
		+30 dB Gain	0.04		%
I²C BUS TIMING					
f_{MAX}	Maximum Bus Frequency			400	kHz
$T_{START:HOLD}$	Start Signal: Hold Time before Clock/Data Transitions			0.6	μs
$T_{D:SETUP}$	Data Setup Time			0.1	μs
$T_{C:HIGH}$	Minimum High Clock Duration			0.6	μs
$T_{C:LOW}$	Minimum Low Clock Duration			1.3	μs
$T_{STOP:SETUP}$	Stop Signal: Setup Time before Clock/Data Transitions			0.6	μs
I²C BUS INPUT AND OUTPUT					
V_{IL}	Input Low Voltage			1.5	V (max)

Electrical Characteristics for Entire IC (Notes 1, 2) (Continued)

The following specifications apply for $V_{DD} = 5V$ unless otherwise noted. Limits apply for $T_A = 25^\circ C$.

Symbol	Parameter	Conditions	LM4832		Units (Limits)
			Typical (Note 6)	Limit (Note 7)	
I²C BUS INPUT AND OUTPUT					
V_{IH}	Input High Voltage			3	V (min)
I_{IN}	Input Current		0.15		μA
V_O	Output Voltage—SDA Acknowledge			0.4	V (max)
V_{OL}	External Power Amp Disable Low			0.4	V (max)
V_{OH}	External Power Amp Disable High			4	V (min)

Note 1: All voltages are measured with respect to the ground pins, unless otherwise specified. All specifications are tested using the typical applications shown in Figure 1.

Note 2: Absolute Maximum Ratings indicate limits beyond which damage to the device may occur. Operating Ratings indicate conditions for which the device is functional, but do not guarantee specific performance limits. Electrical Characteristics state DC and AC electrical specifications under particular test conditions which guarantee specific performance limits. This assumes that the device is within the Operating Ratings. Specifications are not guaranteed for parameters where no limit is given, however, the typical value is a good indication of device performance.

Note 3: The maximum power dissipation must be derated at elevated temperatures and is dictated by T_{JMAX} , θ_{JA} , and the ambient temperature T_A . The maximum allowable power dissipation is $P_{DMAX} = (T_{JMAX} - T_A)/\theta_{JA}$. For the LM4832, $T_{JMAX} = 150^\circ C$, and the typical junction-to-ambient thermal resistance, when board mounted, is $69^\circ C/W$ assuming the M28B package.

Note 4: Human body model, 100 pF discharged through a 1.5 k Ω resistor.

Note 5: Machine Model, 220 pF–240 pF discharged through all pins.

Note 6: Typicals are measured at $25^\circ C$ and represent the parametric norm.

Note 7: Limits are guaranteed that all parts are tested in production to meet the stated values.

Typical Application Circuit

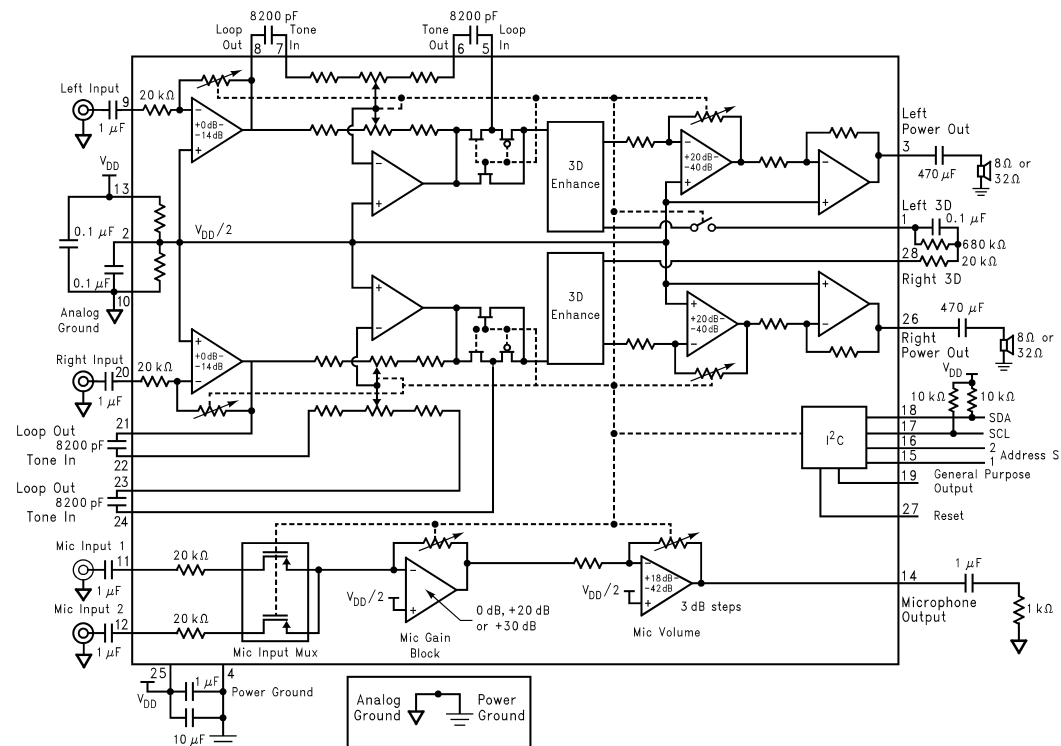

FIGURE 2. Typical Application Circuit

DS100014-3

Pin Description

LEFT 3D (1) RIGHT 3D (28)	An external RC network is connected across these pins. This function provides left-right channel cross coupling and cancellation to create an enhanced stereo channel separation effect.	CLOCK (17)	This pin is the input for the I ² C clock signal.
BYPASS (2)	A 0.1 μ F capacitor is placed between this pin and ground to provide an AC ground for the internal half-supply voltage reference. The capacitor at this pin affects "click-pop" and THD performance. Turn-on and turn-off times are also determined by this capacitor. Refer to the Application Information section for more information.	DATA (18)	This pin is the input for the I ² C data signal.
POWER AMP OUT LEFT (3) RIGHT (26)	These outputs are intended to drive 8 Ω speakers or 32 Ω headphones. These outputs should be AC-coupled to the loads. Refer to the Application Information section for more information.	GENERAL PURPOSE OUTPUT (19)	This pin provides a general purpose TTL/CMOS output. Please refer to the Application Information section for more information.
POWER GND (4)	This pin provides the high current return for the power output stage MOSFETs and digital circuitry.	RESET (27)	This pin is a TTL/CMOS input which is used to reset the chip logic and states.
LOOP OUT (8, 21) LOOP IN (5, 24)	These pins allow an external signal processor access to the stereo signal. Please see the Application Information section for more information.		
TONE OUT (6, 23)	These pins are connected to the tone control op amp outputs and drive the power amplifier inputs. Refer to the Application Information section for more information.		
TONE IN (7, 22)	These pins are connected to the inputs of the tone control op amps. A capacitor between the Tone In and Tone Out pins sets the frequency response of the tone functions. Please refer to the Application Information section for more information.		
INPUTS (9, 20)	These pins are the stereo inputs for the LM4832. These pins should be AC-coupled to the input signals.		
ANALOG GND (10)	This pin is the AC analog ground for the line level AC signal inputs.		
MIC INPUTS (11, 12)	These pins are the two independent selectable microphone inputs. These pins should be AC-coupled.		
MIC OUT (14)	This pin is the output for the microphone amplifier and should be AC-coupled to the load.		
V _{DD} (13, 25)	These pins are for the 5V supply. These pins should be separately bypassed by 0.1 μ F, or higher, film capacitors. The 5V supply should be bypassed by a 10 μ F, or higher, tantalum or aluminum electrolytic capacitor.		
ADDRESS BITS (15, 16)	These pins are used to determine the I ² C address for the LM4832.		

Typical Performance Characteristics

THD+N vs Frequency, 8Ω

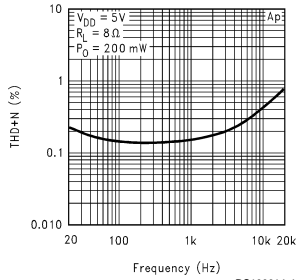

THD+N vs Frequency, 32Ω

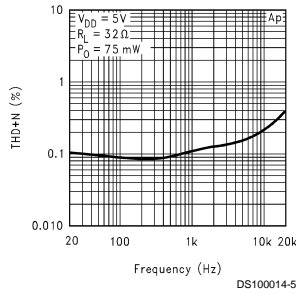

THD+N vs Frequency, 1 kΩ

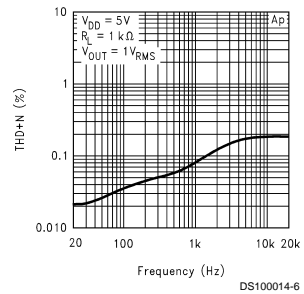

THD+N vs Output Power

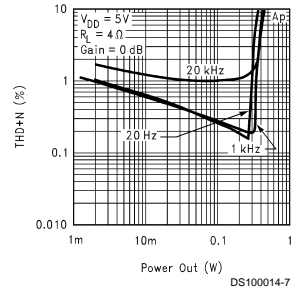

THD+N vs Output Power

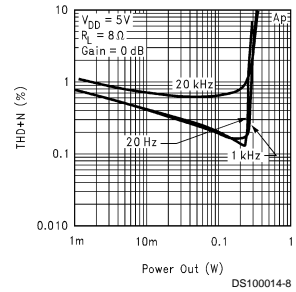

THD+N vs Output Power

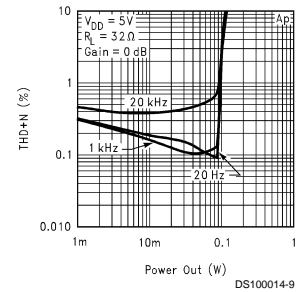

Power Amplifier Crosstalk

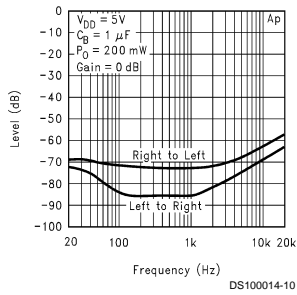

Power Amplifier Noise Floor

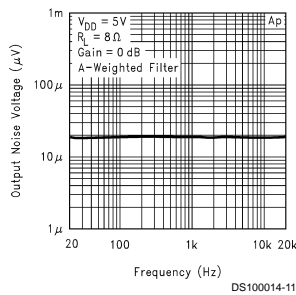

Power Amplifier Attenuation vs Frequency

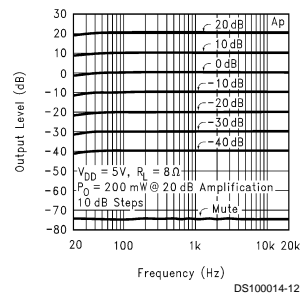

Typical Performance Characteristics (Continued)

Power Supply Rejection Ratio

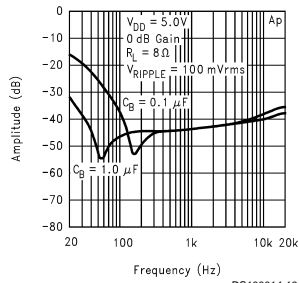

DS100014-13

Power Dissipation vs Output Power

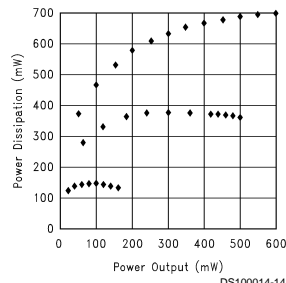

DS100014-14

Power Derating Curve

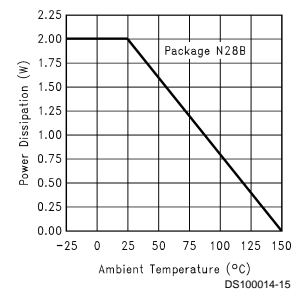

DS100014-15

Mic Amplifier Crosstalk from Power Amplifier

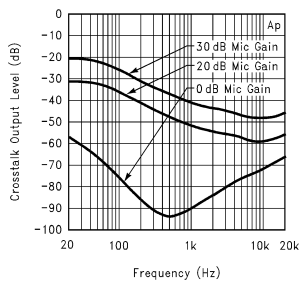

DS100014-16

Mic Amplifier Noise Floor

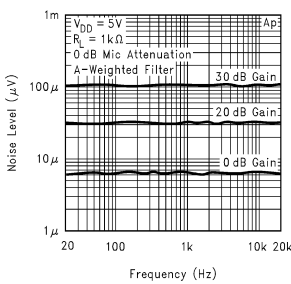

DS100014-17

Mic Amplifier Attenuation vs Frequency

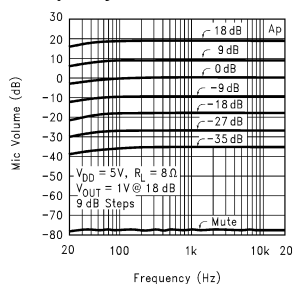

DS100014-18

Mic Amplifier Gain vs Frequency

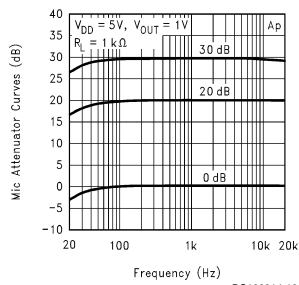

DS100014-19

Mic Amplifier THD+N vs Frequency

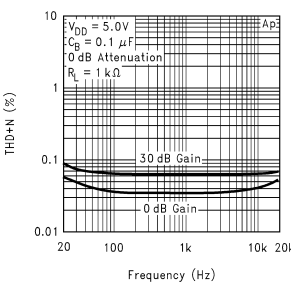

DS100014-20

Loop-out THD+N vs Frequency

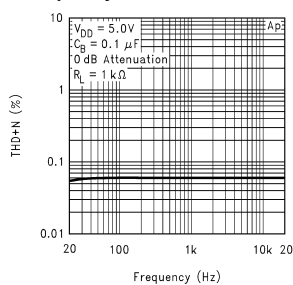

DS100014-21

Typical Performance Characteristics (Continued)

Bass Response vs Frequency

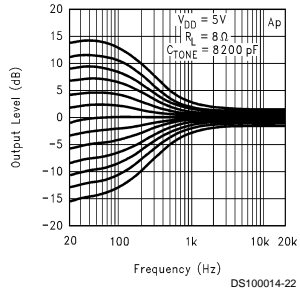

Treble Response vs Frequency

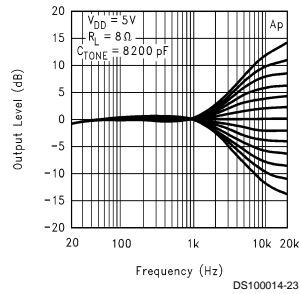

Bass and Treble Response vs Frequency

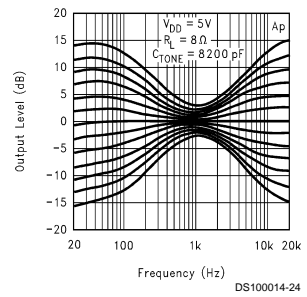

Supply Current vs Temperature

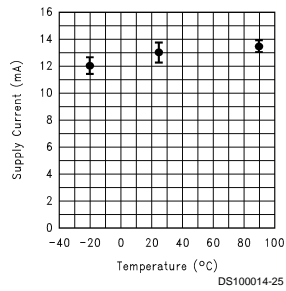

Timing Diagram

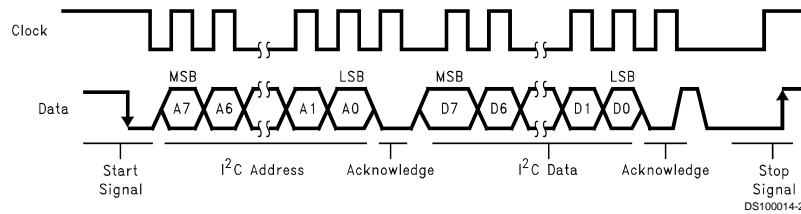
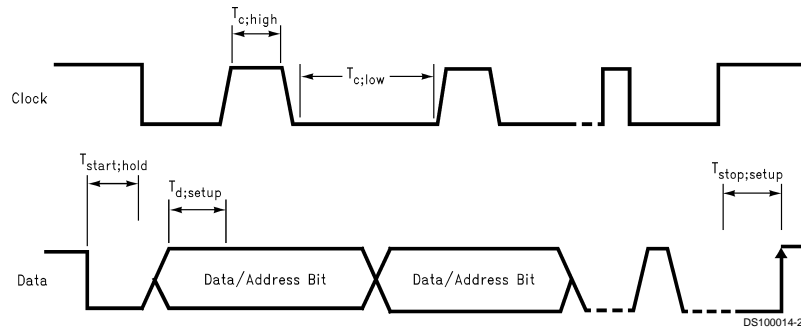

FIGURE 3. I²C Bus Format

Timing Diagram (Continued)



See Electrical Characteristics section for timing specifications

FIGURE 4. I²C Timing Diagram

Truth Tables

SOFTWARE SPECIFICATION

Chip Address

MSB						LSB		
1	0	0	0	0	0	*E.C.	*E.C.	0

*E.C. = Externally Configurable

Data Bytes (Brief Description)

MSB					LSB			Function
0	0	0	X	X	D2	D1	D0	Input Volume Control
0	0	1	X	D3	D2	D1	D0	Bass Control
0	1	0	X	D3	D2	D1	D0	Treble Control
0	1	1	D4	D3	D2	D1	D0	Right Output Vol./Mute
1	0	0	D4	D3	D2	D1	D0	Left Output Vol./Mute
1	0	1	X	D ₁ 1	D ₁ 0	D ₀ 1	D ₀ 0	Mic Input and Gain
1	1	0	D4	D3	D2	D1	D0	Microphone Volume
1	1	1	D ₄ 0	D ₃ 0	D ₂ 0	D ₁ 0	D ₀ 0	General Control

Input Volume Control

MSB					LSB			Attenuation (dB)
0	0	0	X	X	0	0	0	0
0	0	0	X	X	0	0	1	-2
0	0	0	X	X	0	1	0	-4
0	0	0	X	X	0	1	1	-6
0	0	0	X	X	1	0	0	-8
0	0	0	X	X	1	0	1	-10
0	0	0	X	X	1	1	0	-12
0	0	0	X	X	1	1	1	-14
Input Volume Control Power Up State			X	X	0	0	0	Input Volume Control at 0 dB Attenuation

Bass Control

MSB					LSB			Level (dB)
0	0	1	X	0	0	0	0	-12
0	0	1	X	0	0	0	1	-10
0	0	1	X	0	0	1	0	-8
0	0	1	X	0	0	1	1	-6
0	0	1	X	0	1	0	0	-4
0	0	1	X	0	1	0	1	-2
0	0	1	X	0	1	1	0	0
0	0	1	X	0	1	1	1	2
0	0	1	X	1	0	0	0	4
0	0	1	X	1	0	0	1	6
0	0	1	X	1	0	1	0	8
0	0	1	X	1	0	1	1	10
0	0	1	X	1	1	0	0	12
Bass Control Power Up State			X	0	1	1	0	Bass Control is Flat

Truth Tables (Continued)

Treble Control

MSB								LSB	Level (dB)
0	1	0	X	0	0	0	0	-12	
0	1	0	X	0	0	0	1	-10	
0	1	0	X	0	0	1	0	-8	
0	1	0	X	0	0	1	1	-6	
0	1	0	X	0	1	0	0	-4	
0	1	0	X	0	1	0	1	-2	
0	1	0	X	0	1	1	0	0	
0	1	0	X	0	1	1	1	2	
0	1	0	X	1	0	0	0	4	
0	1	0	X	1	0	0	1	6	
0	1	0	X	1	0	1	0	8	
0	1	0	X	1	0	1	1	10	
0	1	0	X	1	1	0	0	12	
Treble Control Power Up State			X	0	1	1	0	Treble Control is Flat	

Left Volume Control

MSB								LSB	Function
1	0	0	0	0	0	0	0	20	
1	0	0	0	0	0	0	1	18	
1	0	0	
1	0	0	1	1	1	0	1	-38	
1	0	0	1	1	1	1	0	-40	
1	0	0	1	1	1	1	1	Left Channel Mute	
Left Volume Control Power Up State			1	1	1	1	1	Left Channel is Muted	

General Control

MSB								LSB	Function	
1	1	1						0	Chip On	
1	1	1						1	Chip Shutdown	
1	1	1						0	G.P.O. Output Low	
1	1	1						1	G.P.O. Output High	
1	1	1						0	Stereo Enhance Off	
1	1	1						1	Stereo Enhance On	
1	1	1						0	Stereo Operation	
1	1	1						1	Mono Force On	
1	1	1	0							External Loop Disable
1	1	1	1							External Loop Enable
General Control Power Up State			0	0	0	0	0			

Truth Tables (Continued)

Right Volume Control

MSB								LSB	Level (dB)
0	1	1	0	0	0	0	0	0	20
0	1	1	0	0	0	0	1	1	18
0	1	1
0	1	1	1	1	1	0	0	0	-38
0	1	1	1	1	1	1	0	0	-40
0	1	1	1	1	1	1	1	1	Right Channel Mute
Right Volume Control Power Up State			1	1	1	1	1	1	Right Channel Is Muted

Microphone Input Selection and Gain

MSB						LSB		Function
1	0	1	X			0	0	Mic Input 1
1	0	1	X			0	1	Mic Input 2
1	0	1	X			1	X	Mic Input 1 and 2
1	0	1	X	0	0			Mic Gain (+0 dB)
1	0	1	X	0	1			Mic Gain (+20 dB)
1	0	1	X	1	0			Mic Gain (+30 dB)
Mic Input Sel. and Gain Power Up State			X	1	0	0	0	Mic 1 is selected with a +30 dB gain

Microphone Volume Control

MSB							LSB	Function
1	1	0	0	0	0	0	0	18
1	1	0	0	0	0	0	1	15
1	1	0
1	1	0	1	0	1	0	0	-42
1	1	0	1	0	1	0	1	Microphone Muted
Mic Volume Control Power Up State			1	0	1	0	1	Microphone Muted

Application Information

GROUNDING

In order to achieve the best possible performance, certain grounding techniques should be followed. All input reference grounds should be tied with their respective source grounds and brought back to the power supply ground separately from the output load ground returns. These input grounds should also be tied in with the half-supply bypass ground. Bringing the ground returns for the output loads back to the supply separately will keep large signal currents from interfering with the stable AC input ground references.

LAYOUT

As stated in the Grounding section, placement of ground return lines is critical for maintaining the highest level of system performance. It is not only important to route the correct ground return lines together, but also important to be aware of where those ground return lines are routed in conjunction with each other. The output load ground returns should be physically located as far as reasonably possible from low signal level lines and their ground return lines. Critical signal lines are those relating to the microphone amplifier section, since these lines generally work at very low signal levels.

SUPPLY BYPASSING

As with all op amps and power op amps, the LM4832 requires the supplies to be bypassed to avoid oscillation. To avoid high frequency instabilities, a 0.1 μF metallized-film or ceramic capacitor should be used to bypass the supplies as close to the chip as possible. For low frequency considerations, a 10 μF or greater tantalum or electrolytic capacitor should be paralleled with the high frequency bypass capacitor.

If power supply bypass capacitors are not sufficiently large, the current in the power supply leads, which is a rectified version of the output current, may be fed back into internal circuitry. This internal feedback signal can cause high frequency distortion and oscillation.

If power supply lines to the chip are long, larger bypass capacitors could be required. Long power supply leads have inductance and resistance associated with them, that could prevent peak low frequency current demands from being met. The extra bypass capacitance will reduce the peak current requirements from the power supply lines.

POWER-UP STATUS

On power-up or after a hard reset, the LM4832 registers will be initialized with the default values listed in the truth tables. By default, the LM4832 power and microphone outputs are muted, the tone controls are all flat, National 3D Enhance is off, the chip is in stereo mode, and the microphone input 1 is selected with +30 dB of gain.

CLICK AND POP CIRCUITRY

The LM4832 contains circuitry to minimize turn-on transients or "click and pops". In this case, turn-on refers to either power supply turn-on or the device coming out of shutdown mode. When the device is turning on, the amplifiers are internally configured as unity gain buffers. An internal current source charges the bypass capacitor on the bypass pin. Both the inputs and outputs ideally track the voltage at the bypass pin. The device will remain in buffer mode until the

bypass pin has reached its half supply voltage, $1/2 V_{DD}$. As soon as the bypass node is stable, the device will become fully operational.

Although the bypass pin current source cannot be modified, the size of the bypass capacitor, C_B , can be changed to alter the device turn-on time and the amount of "click and pop". By increasing C_B , the amount of turn-on pop can be reduced. However, the trade-off for using a larger bypass capacitor is an increase in the turn-on time for the device. Reducing C_B will decrease turn-on time and increase "click and pop". If C_B is too small, the LM4832 can develop a low-frequency oscillation ("motorboat") when used at high gains.

There is a linear relationship between the size of C_B and the turn-on time. Some typical turn-on times for different values of C_B are:

C_b	T_{ON}
0.01 μF	20 ms
0.1 μF	200 ms
0.22 μF	420 ms

In order to eliminate "click and pop", all capacitors must be discharged before turn-on. Rapid on/off switching of the device or shutdown function may cause the "click and pop" circuitry to not operate fully, resulting in increased "click and pop" noise. The output coupling cap, C_O , is of particular concern. This capacitor discharges through an internal 20 k Ω resistor. Depending on the size of C_O , the time constant can be quite large. To reduce transients, an external 1 k Ω –5 k Ω resistor can be placed in parallel with the internal 20 k Ω resistor. The tradeoff for using this resistor is an increase in quiescent current.

COUPLING CAPACITORS

Because the LM4832 is a single supply circuit, all audio signals must be capacitor coupled to the chip to remove the $2.5 V_{DC}$ bias. All audio inputs have 20 k Ω input impedances, so the AC-coupling capacitor will create a high-pass filter with

$$f_{-3dB} = 1/(2\pi \cdot 20 \text{ k}\Omega \cdot C_{IN}).$$

The amplifier outputs also need to be AC-coupled to the loads. The high-pass filter is comprised of the output load and the coupling capacitor, where the filter cutoff is at

$$f_{-3dB} = 1/(2\pi \cdot R_{LOAD} \cdot C_{OUT}).$$

POWER AMPLIFIER

The power amplifiers in the LM4832 are designed to drive 8 Ω or 32 Ω loads at 200 mW (continuous) and 75 mW (continuous), respectively, with 1% THD+N. As shown in the Typical Performance Characteristics, the power amplifiers typically drive 4 Ω loads at 350 mW, but with a slight increase in high-frequency THD. As discussed above, these outputs should be AC-coupled to the output load.

MICROPHONE AMPLIFIER

The microphone preamplifier is intended to amplify low-level signals for signal conditioning. The microphone inputs can be directly connected to microphone networks. The microphone amplifier has enough output capability to drive a 1 k Ω load. All microphone inputs and outputs must be AC-coupled.

Application Information (Continued)

I²C INTERFACE

The LM4832 uses a serial bus, which conforms to the I²C protocol, to control the chip's functions with two wires: clock and data. The clock line is uni-directional. The data line is bi-directional (open-collector) with a pullup resistor (typically 10 k Ω). The maximum clock frequency specified by the I²C standard is 400 kHz. In this discussion, the master is the controlling microcontroller and the slave is the LM4832.

The I²C address for the LM4832 is determined using the Address Bit 1 and Address Bit 2 TTL/CMOS inputs on the chip. The LM4832's four possible I²C chip addresses are of the form 1000X₂X₁0 (binary), where the X₂ and X₁ bits are determined by the voltage levels at the Address Bit 2 and Address Bit 1 pins, respectively. If the I²C interface is used to address a number of chips in a system and the LM4832's chip address can be changed to avoid address conflicts.

The timing diagram for the I²C is shown in Figure 2. The data is latched in on the stable high level of the clock and the data line should be held high when not in use. The timing diagram is broken up into six major sections:

The "start" signal is generated by lowering the data signal while the clock signal is high. The start signal will alert all devices attached to the I²C bus to check the incoming address against their own chip address.

The 8-bit chip address is sent next, most significant bit first. Each address bit must be stable while the clock level is high.

After the last bit of the address is sent, the master checks for the LM4832's acknowledge. The master releases the data line high (through a pullup resistor). Then the master sends a clock pulse. If the LM4832 has received the address correctly, then it holds the data line low during the clock pulse. If the data line is not low, then the master should send a "stop" signal (discussed later) and abort the transfer.

The 8 bits of data are sent next, most significant bit first. Each data bit should be valid while the clock level is stable high.

After the data byte is sent, the master must generate another acknowledge to see if the LM4832 received the data.

If the master has more data bytes to send to the LM4832, then the master can repeat the previous two steps until all data bytes have been sent.

The "stop" signal ends the transfer. To signal "stop", the data signal goes high while the clock signal is high.

3D AUDIO ENHANCEMENT

The LM4832 has a 3D audio enhancement effect that helps improve the apparent stereo channel separation when, because of cabinet or equipment limitations, the left and right speakers are closer to each other than optimal.

An external RC network, shown in Figure 3, is required to enable the effect. The amount of the effect is set by the 20 k Ω resistor. A 0.1 μ F capacitor is used to reduce the effect at frequencies below 80 Hz. Decreasing the resistor size will make the 3D effect more pronounced and decreasing the capacitor size will raise the cutoff frequency for the effect.

The 680 k Ω resistor across the 0.1 μ F capacitor reduces switching noise by discharging the capacitor when the effect is not in use.

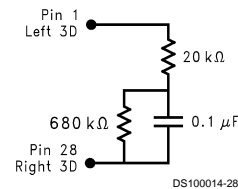

FIGURE 5. 3D Effect Components

TONE CONTROL RESPONSE

Bass and treble tone controls are included in the LM4832. The tone controls use two external capacitors for each stereo channel. Each has a corner frequency determined by the value of C2 and C3 (see Figure 4) and internal resistors in the feedback loop of the internal tone amplifier.

Typically, C2 = C3 and for 100 Hz and 10 kHz corner frequencies, C2 = C3 = 0.0082 μ F. Altering the ratio between C2 and C3, changes the midrange gain. For example, if C2 = 2(C3), then the frequency response will be flat at 20 Hz and 20 kHz, but will have a 6 dB peak at 1 kHz.

With C = C2 = C3, the treble turn-over frequency is nominally

$$f_{TT} = 1/(2\pi C(14 \text{ k}\Omega))$$

and the bass turn-over frequency is nominally

$$f_{BT} = 1/(2\pi C(30.4 \text{ k}\Omega)),$$

when maximum boost is chosen. The inflection points (the frequencies where the boost or cut is within 3 dB of the final value) are, for treble and bass respectively,

$$f_{T1} = 1/(2\pi C(1.9 \text{ k}\Omega))$$

$$f_{B1} = 1/(2\pi C(169.6 \text{ k}\Omega))$$

Increasing the values of C2 and C3 decreases the turnover and inflection frequencies: i.e., the Tone Control Response Curves shown in **Typical Performance Section** will shift left when C2 and C3 are increased and shift right when C2 and C3 are decreased. With C2 = C3 = 0.0082 μ F, 2 dB steps are achieved at 100 Hz and 10 kHz. Changing C2 and C3 to 0.01 μ F shifts the 2 dB step frequency to 72 Hz and 8.3 kHz. If the tone control capacitors' size is decreased these frequencies will increase. With C2 = C3 = 0.0068 μ F the 2 dB steps take place at 130 Hz and 11.2 kHz.

Application Information (Continued)

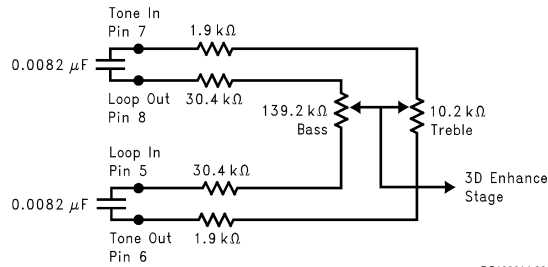

FIGURE 6. Tone Control Diagram

GENERAL PURPOSE OUTPUT PIN

The General Purpose Output pin is intended to be used as a control signal for other devices, such as an external power amplifier. This pin is controlled through the I²C interface and is not related to any other functions within the LM4832. Refer to the Truth Tables section for the proper I²C data bits to utilize this function.

Figure 7 shows an example of using the General Purpose Output to interface with an external power amp. In this case, the external power amp is the LM4755 stereo 10 watt per

channel (rms) power amplifier with mute. AC-coupling capacitors must be used to remove the DC bias present between the LM4832 outputs and the external power amplifier inputs.

Prior to placing any of the preamp circuitry in shutdown, the General Purpose Output should be used to disable the external power amplifier. This will prevent any shutdown transients in the preamp circuitry from being amplified by the external power amplifier.

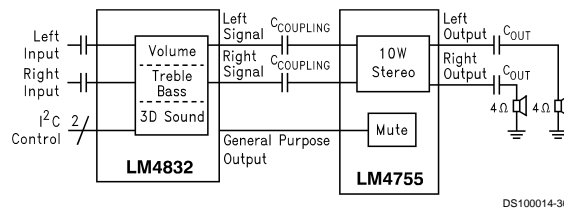

10W/ch System with I²C Controlled Tone, Volume and 3D Sound

LOOP IN/OUT PINS

The Loop In and Loop Out pins are used when an application requires a special function to be performed on the audio signal. As shown in Figure 7, the audio signal is taken from the Loop Out pin and sent to an external signal processor. After the signal is processed externally, it is fed back into the Loop In pin.

An example of where this functionality would be used is computer speakers. The external loop could be used to provide bass boost to counteract the speaker's natural or baffle-induced rolloff.

Since the Loop In pin goes directly to the input of a CMOS amplifier, the input impedance is very high. The Loop Out pin is driven by the input attenuation amplifier, which is capable of driving impedances as low as 1 kΩ.

Application Information (Continued)

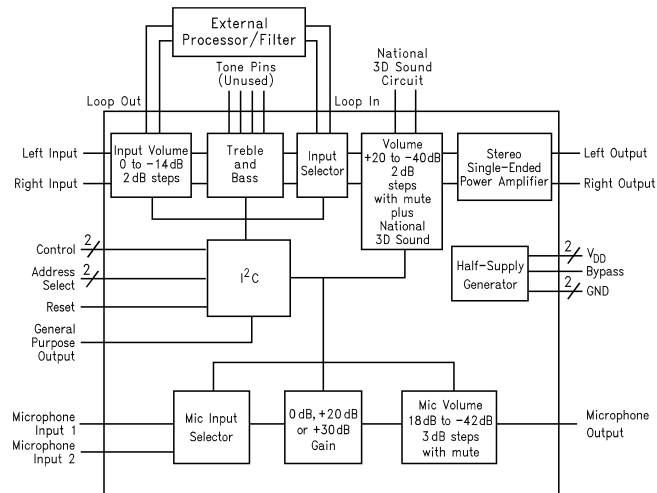

DS100014-31

LM4832 SAMPLE LAYOUT

Name	LAYOUT PARTS LIST Type	Quantity
Capacitors:		
C_{OUT}	1000 μ F, elec., Digikey #P6205	4
C_{MOUT}	47 μ F, elec., Digikey #P5202	1
C_S	0.33 μ F, film, Digikey #P4669	3
C_{TONE}	8200 pF, ceramic, Digikey #P4823	4
C_{LIN}, C_{MIN}, C_{IN}	1 μ F, film, Digikey #E1105	6
C_B	0.33 μ F, film, Digikey #EF1334	1
C_1	0.1 μ F, film, Digikey #EF1104	1

Resistors (all resistors: Digikey #(Value)QBK):

R1	20 k Ω , 1/4W	1
R2	680 k Ω , 1/4W	1
R_{DATA}	1 k Ω , 1/4W	1
R_{GND}	100 Ω , 1/4W	1
R_{PD}	100 k Ω , 1/4W	1

LAYOUT PARTS LIST

Name	Type	Quantity
Connectors:		
Banana Jack		
Black	Mouser #164-6218	3
Red	Mouser #164-6218	3
RCA Jack	Mouser #16PJ097	7
Stereo	Shogyo #JJ-0357-3RT	1
Headphone		
Mono Miniplug	Shogyo #JJ-0357-B	2
36-pin	Digikey #1036RF	1
Centronics		

LAYOUT DESCRIPTION

The layout given in the following pages is meant to be connected to a PC by a parallel port (printer) cable. The board is controlled by software for a Windows PC. The parallel cable must be the standard type used for hooking up a printer to a PC: one end is a DB-25 connector and the other is a 36 pin Centronics connector.

Banana connections are provided for V_{DD} , ground, and amplifier outputs. Amplifier outputs are also routed to a stereo headphone jack. RCA connections are provided for amplifier inputs, loop in, loop out, and microphone out. Mono mini-plug connectors are provided for microphone inputs.

If required, microphones can be biased using the resistors R_{MIC1} and R_{MIC2} .

This layout is set up to allow the use of the internal tone-control circuitry or the external loop. The jumper next to each C_{LIN} capacitor controls which route the signal should take.

Typical Application PCB Layout (All Layers)

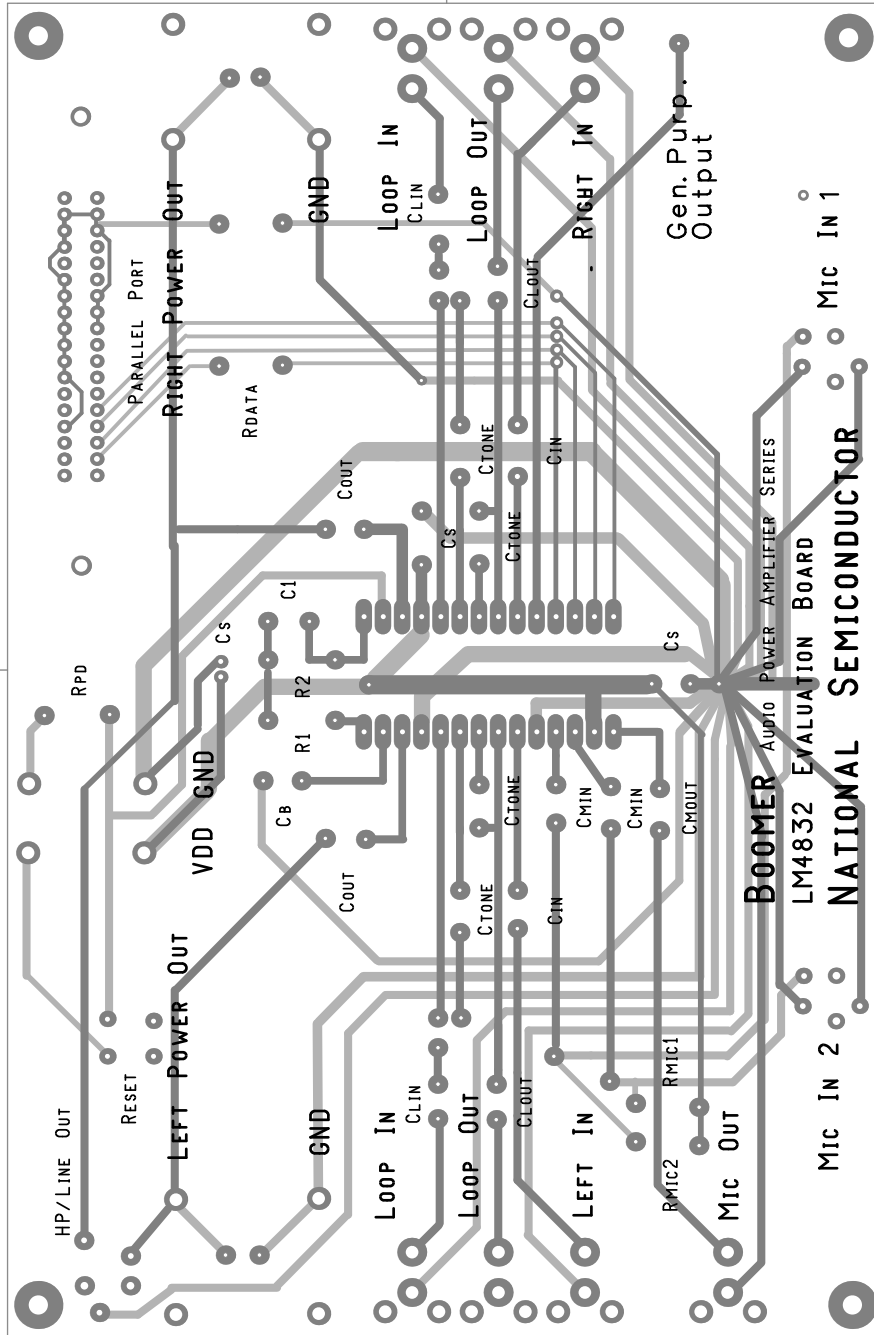

DS100014-32

Typical Application PCB Layout (Silkscreen Layer)

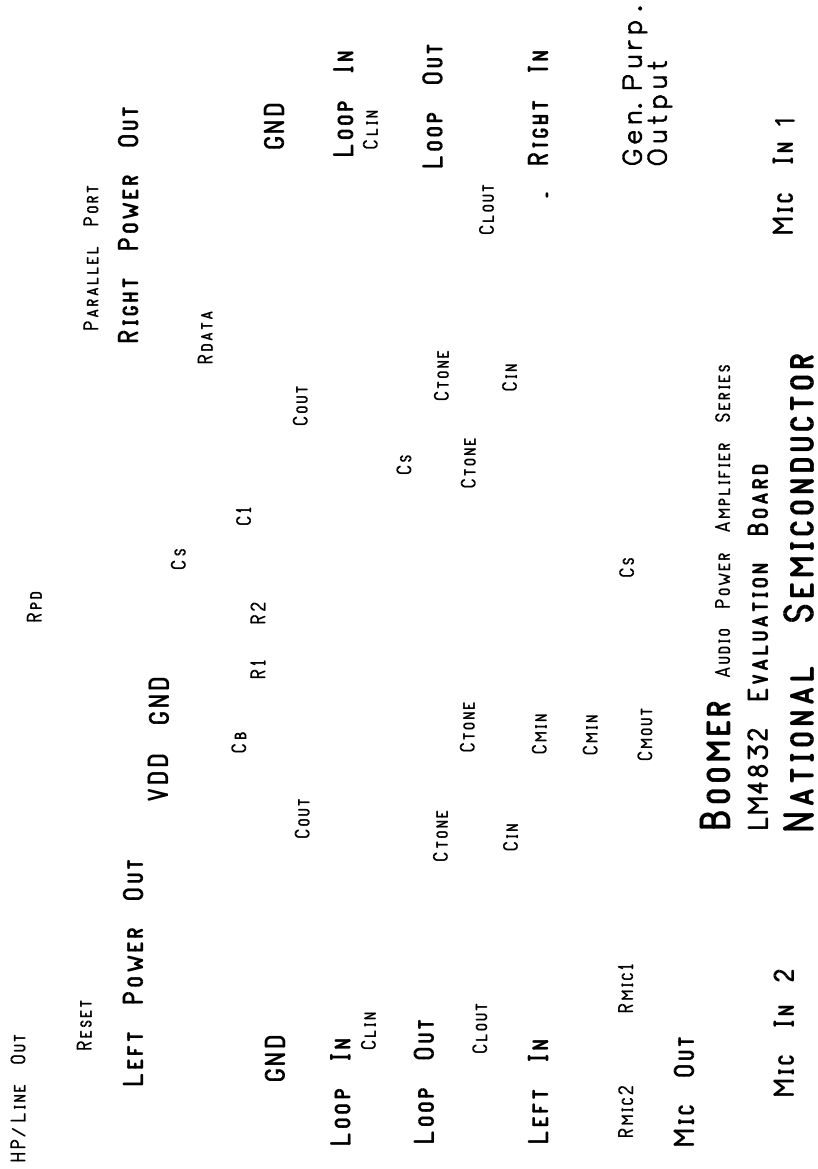

DS100014-33

Typical Application PCB Layout (Bottom Layer)

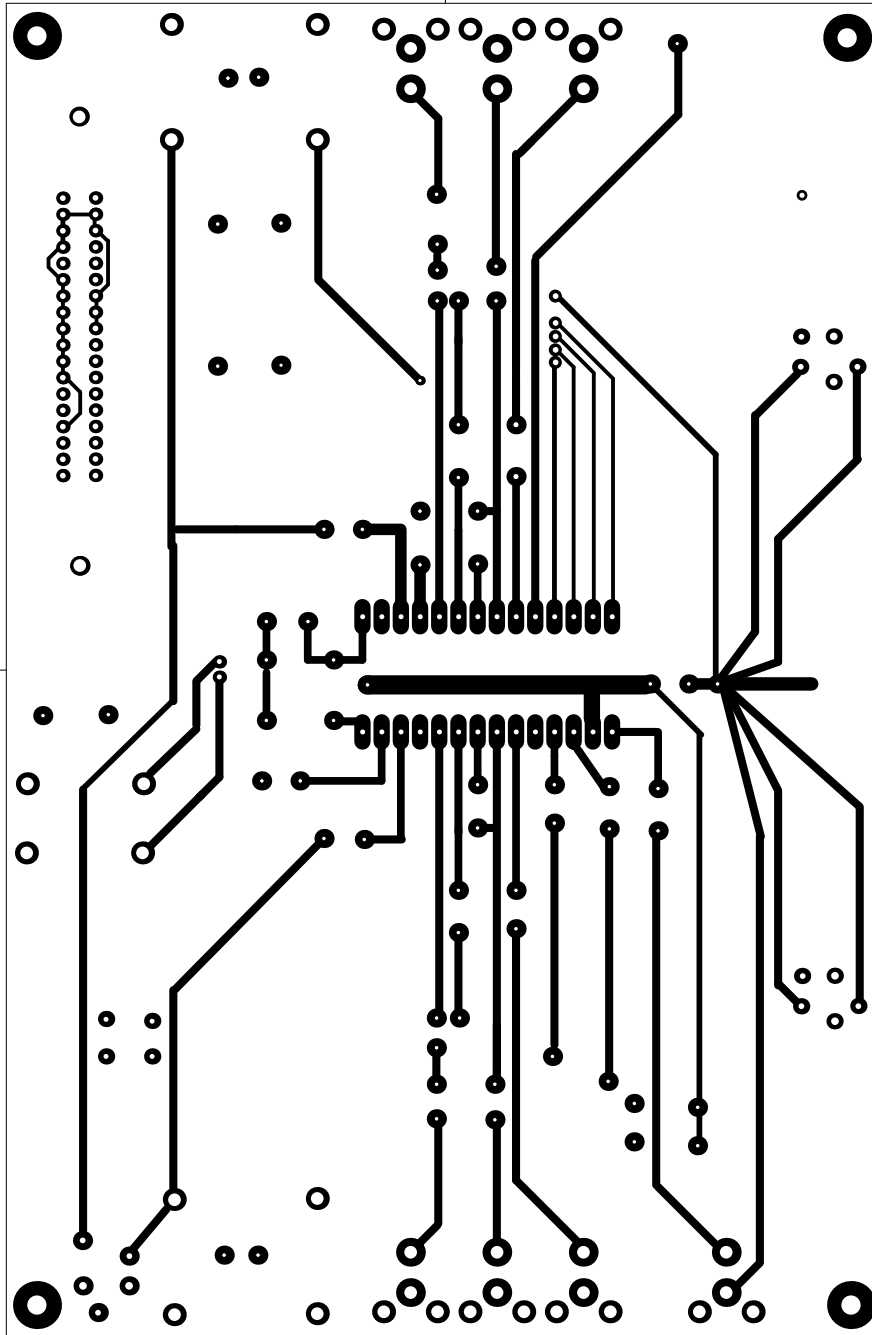

DS100014-34

Typical Application PCB Layout (Top Layer)

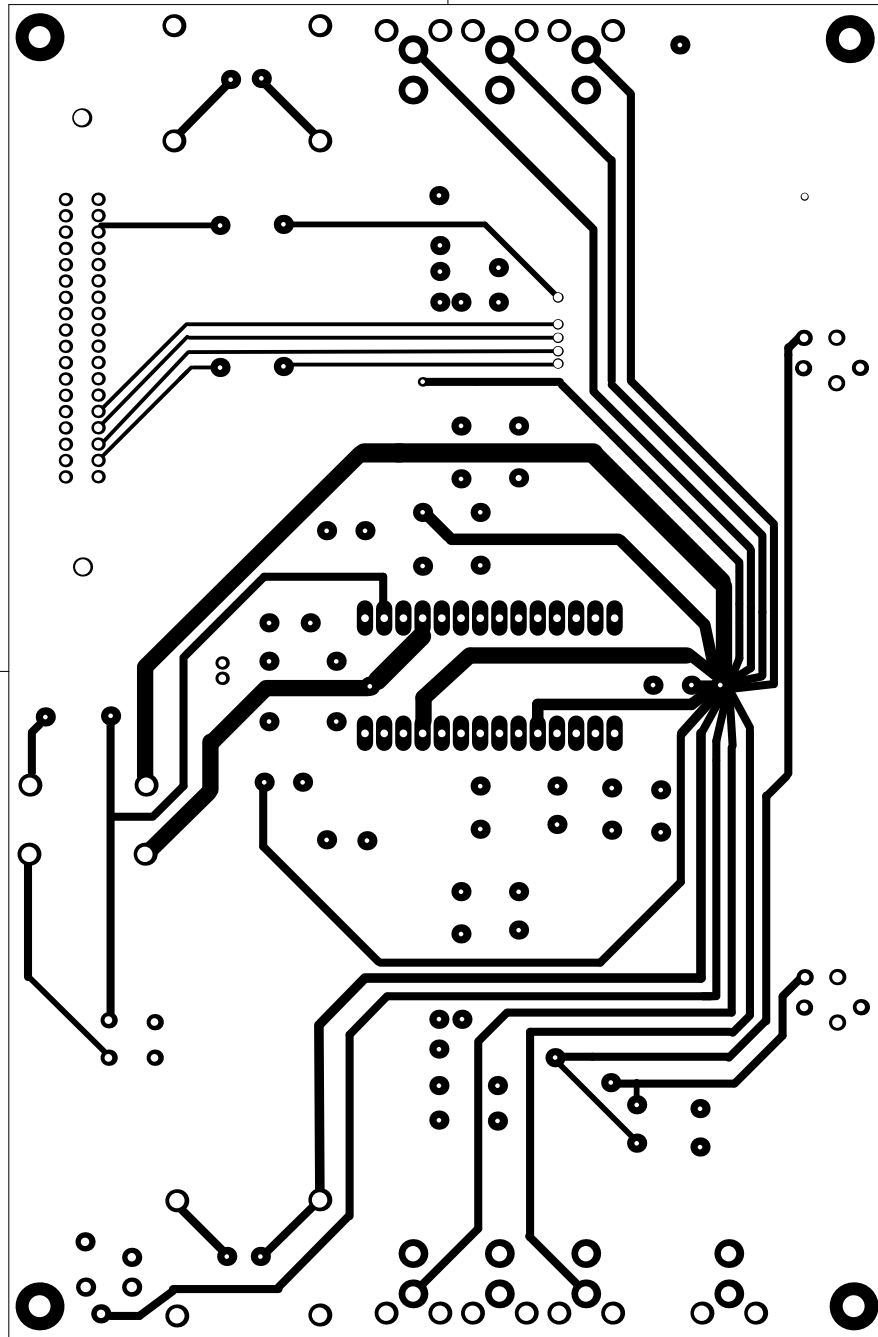

DS100014-35

Physical Dimensions inches (millimeters) unless otherwise noted

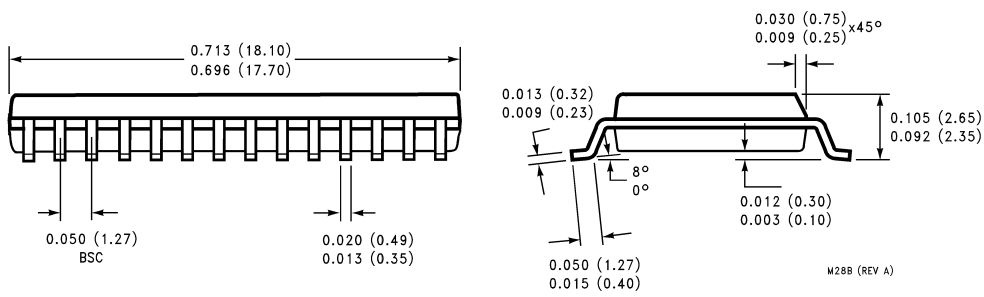
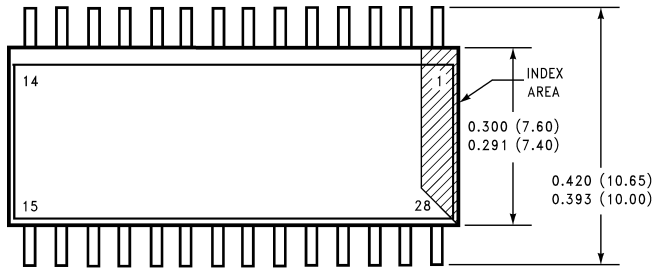

28-Lead SOIC Package (M28B)
Order Number LM4832M
NS Package Number M28B for SOIC

LM4832 Digitally Controlled Tone and Volume Circuit with Stereo Audio Power Amplifier, Microphone Preamp Stage and National 3D Sound

Physical Dimensions inches (millimeters) unless otherwise noted (Continued)

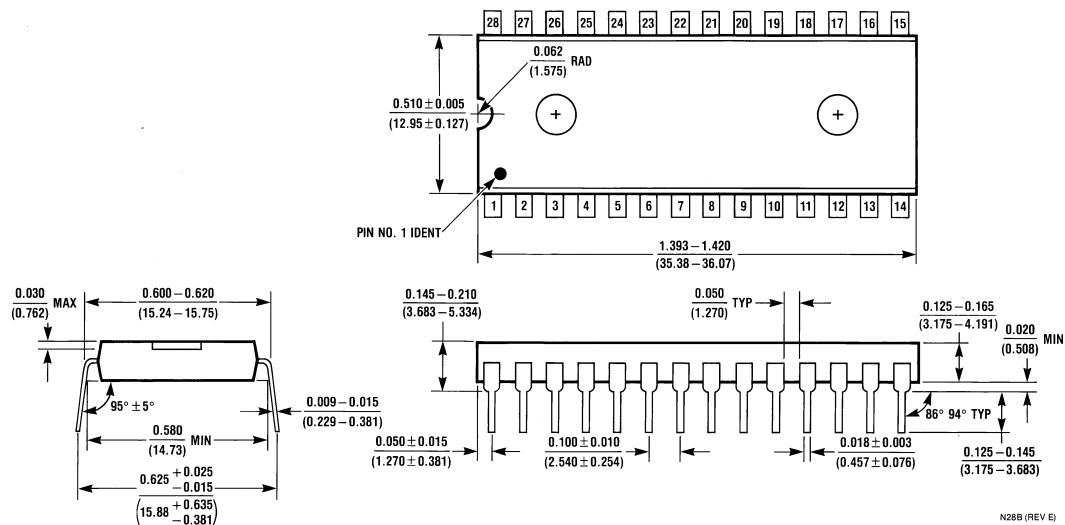

28-Lead Dual-In-Line Package (N28B)
Order Number LM4832N
NS Package Number N28B for DIP

LIFE SUPPORT POLICY

NATIONAL'S PRODUCTS ARE NOT AUTHORIZED FOR USE AS CRITICAL COMPONENTS IN LIFE SUPPORT DEVICES OR SYSTEMS WITHOUT THE EXPRESS WRITTEN APPROVAL OF THE PRESIDENT OF NATIONAL SEMICONDUCTOR CORPORATION. As used herein:

1. Life support devices or systems are devices or systems which, (a) are intended for surgical implant into the body, or (b) support or sustain life, and whose failure to perform when properly used in accordance with instructions for use provided in the labeling, can be reasonably expected to result in a significant injury to the user.
2. A critical component in any component of a life support device or system whose failure to perform can be reasonably expected to cause the failure of the life support device or system, or to affect its safety or effectiveness.

 **National Semiconductor Corporation**
 Americas
 Tel: 1-800-272-9959
 Fax: 1-800-737-7018
 Email: support@nsc.com
 www.national.com

National Semiconductor Europe
 Fax: +49 (0) 1 80-530 85 86
 Email: europe.support@nsc.com
 Deutsch Tel: +49 (0) 1 80-530 85 85
 English Tel: +49 (0) 1 80-532 78 32
 Français Tel: +49 (0) 1 80-532 93 58
 Italiano Tel: +49 (0) 1 80-534 16 80

National Semiconductor Asia Pacific Customer Response Group
 Tel: 65-2544466
 Fax: 65-2504466
 Email: sea.support@nsc.com

National Semiconductor Japan Ltd.
 Tel: 81-3-5620-6175
 Fax: 81-3-5620-6179

National does not assume any responsibility for use of any circuitry described, no circuit patent licenses are implied and National reserves the right at any time without notice to change said circuitry and specifications.

Copyright © Each Manufacturing Company.

All Datasheets cannot be modified without permission.

This datasheet has been download from :

www.AllDataSheet.com

100% Free DataSheet Search Site.

Free Download.

No Register.

Fast Search System.

www.AllDataSheet.com