

# Triple 3-Input NAND Gate

## High-Performance Silicon-Gate CMOS

The MC74HC10 is identical in pinout to the LS10. The device inputs are compatible with standard CMOS outputs; with pullup resistors, they are compatible with LSTTL outputs.

- Output Drive Capability: 10 LSTTL Loads
- Outputs Directly Interface to CMOS, NMOS, and TTL
- Operating Voltage Range: 2 to 6 V
- Low Input Current: 1  $\mu$ A
- High Noise Immunity Characteristic of CMOS Devices
- In Compliance with the Requirements Defined by JEDEC Standard No. 7A
- Chip Complexity: 36 FETs or 9 Equivalent Gates

### LOGIC DIAGRAM

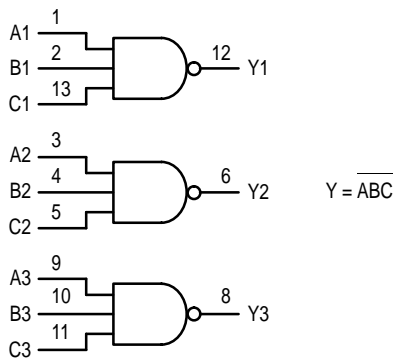

PIN 14 =  $V_{CC}$   
PIN 7 = GND

# MC74HC10

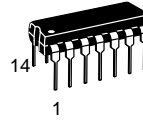

**N SUFFIX**  
PLASTIC PACKAGE  
CASE 646-06



**D SUFFIX**  
SOIC PACKAGE  
CASE 751A-03

### ORDERING INFORMATION

MC74HCXXN Plastic  
MC74HCXXD SOIC

### PIN ASSIGNMENT

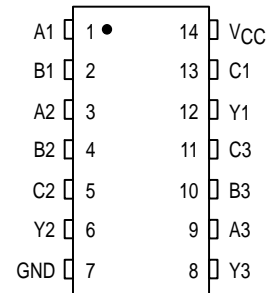

### FUNCTION TABLE

Inputs			Output
A	B	C	Y
L	X	X	H
X	L	X	H
X	X	L	H
H	H	H	L



# MC74HC10

## MAXIMUM RATINGS\*

Symbol	Parameter	Value	Unit
V <sub>CC</sub>	DC Supply Voltage (Referenced to GND)	- 0.5 to + 7.0	V
V <sub>in</sub>	DC Input Voltage (Referenced to GND)	- 1.5 to V <sub>CC</sub> + 1.5	V
V <sub>out</sub>	DC Output Voltage (Referenced to GND)	- 0.5 to V <sub>CC</sub> + 0.5	V
I <sub>in</sub>	DC Input Current, per Pin	± 20	mA
I <sub>out</sub>	DC Output Current, per Pin	± 25	mA
I <sub>CC</sub>	DC Supply Current, V <sub>CC</sub> and GND Pins	± 50	mA
P <sub>D</sub>	Power Dissipation in Still Air Plastic DIP† SOIC Package†	750 500	mW
T <sub>stg</sub>	Storage Temperature	- 65 to + 150	°C
T <sub>L</sub>	Lead Temperature, 1 mm from Case for 10 Seconds (Plastic DIP or SOIC Package)	260	°C

This device contains protection circuitry to guard against damage due to high static voltages or electric fields. However, precautions must be taken to avoid applications of any voltage higher than maximum rated voltages to this high-impedance circuit. For proper operation, V<sub>in</sub> and V<sub>out</sub> should be constrained to the range GND ≤ (V<sub>in</sub> or V<sub>out</sub>) ≤ V<sub>CC</sub>. Unused inputs must always be tied to an appropriate logic voltage level (e.g., either GND or V<sub>CC</sub>). Unused outputs must be left open.

\* Maximum Ratings are those values beyond which damage to the device may occur. Functional operation should be restricted to the Recommended Operating Conditions.

† Derating — Plastic DIP: - 10 mW/°C from 65° to 125°C  
SOIC Package: -7 mW/°C from 65° to 125°C

For high frequency or heavy load considerations, see Chapter 2 of the Motorola High-Speed CMOS Data Book (DL129/D).

## RECOMMENDED OPERATING CONDITIONS

Symbol	Parameter	Min	Max	Unit	
V <sub>CC</sub>	DC Supply Voltage (Referenced to GND)	2.0	6.0	V	
V <sub>in</sub> , V <sub>out</sub>	DC Input Voltage, Output Voltage (Referenced to GND)	0	V <sub>CC</sub>	V	
T <sub>A</sub>	Operating Temperature, All Package Types	- 55	+ 125	°C	
t <sub>r</sub> , t <sub>f</sub>	Input Rise and Fall Time (Figure 1)	V <sub>CC</sub> = 2.0 V V <sub>CC</sub> = 4.5 V V <sub>CC</sub> = 6.0 V	0 0 0	1000 500 400	ns

## DC ELECTRICAL CHARACTERISTICS (Voltages Referenced to GND)

Symbol	Parameter	Test Conditions	V <sub>CC</sub> V	Guaranteed Limit			Unit
				- 55 to 25°C	≤ 85°C	≤ 125°C	
V <sub>IH</sub>	Minimum High-Level Input Voltage	V <sub>out</sub> = 0.1 V or V <sub>CC</sub> - 0.1 V  I <sub>out</sub>   ≤ 20 μA	2.0	1.5	1.5	1.5	V
			4.5	3.15	3.15	3.15	
			6.0	4.2	4.2	4.2	
V <sub>IL</sub>	Maximum Low-Level Input Voltage	V <sub>out</sub> = 0.1 V or V <sub>CC</sub> - 0.1 V  I <sub>out</sub>   ≤ 20 μA	2.0	0.3	0.3	0.3	V
			4.5	0.9	0.9	0.9	
			6.0	1.2	1.2	1.2	
V <sub>OH</sub>	Minimum High-Level Output Voltage	V <sub>in</sub> = V <sub>IH</sub> or V <sub>IL</sub>  I <sub>out</sub>   ≤ 20 μA	2.0	1.9	1.9	1.9	V
			4.5	4.4	4.4	4.4	
		V <sub>in</sub> = V <sub>IH</sub> or V <sub>IL</sub>  I <sub>out</sub>   ≤ 4.0 mA  I <sub>out</sub>   ≤ 5.2 mA	4.5	3.98	3.84	3.70	
			6.0	5.48	5.34	5.20	
V <sub>OL</sub>	Maximum Low-Level Output Voltage	V <sub>in</sub> = V <sub>IH</sub>  I <sub>out</sub>   ≤ 20 μA	2.0	0.1	0.1	0.1	V
			4.5	0.1	0.1	0.1	
		V <sub>in</sub> = V <sub>IH</sub> or V <sub>IL</sub>  I <sub>out</sub>   ≤ 4.0 mA  I <sub>out</sub>   ≤ 5.2 mA	4.5	0.26	0.33	0.40	
			6.0	0.26	0.33	0.40	
I <sub>in</sub>	Maximum Input Leakage Current	V <sub>in</sub> = V <sub>CC</sub> or GND	6.0	± 0.1	± 1.0	± 1.0	μA
I <sub>CC</sub>	Maximum Quiescent Supply Current (per Package)	V <sub>in</sub> = V <sub>CC</sub> or GND I <sub>out</sub> = 0 μA	6.0	2	20	40	μA

NOTE: Information on typical parametric values can be found in Chapter 2 of the Motorola High-Speed CMOS Data Book (DL129/D).

**AC ELECTRICAL CHARACTERISTICS** ( $C_L = 50$  pF, Input  $t_r = t_f = 6$  ns)

Symbol	Parameter	V <sub>CC</sub> V	Guaranteed Limit			Unit
			- 55 to 25°C	≤ 85°C	≤ 125°C	
t <sub>PLH</sub> , t <sub>PHL</sub>	Maximum Propagation Delay, Input A, B, or C to Output Y (Figures 1 and 2)	2.0	95	120	145	ns
		4.5	19	24	29	
		6.0	16	20	25	
t <sub>TLH</sub> , t <sub>THL</sub>	Maximum Output Transition Time, Any Output (Figures 1 and 2)	2.0	75	95	110	ns
		4.5	15	19	22	
		6.0	13	16	19	
C <sub>in</sub>	Maximum Input Capacitance	—	10	10	10	pF

NOTES:

1. For propagation delays with loads other than 50 pF, see Chapter 2 of the Motorola High-Speed CMOS Data Book (DL129/D).
2. Information on typical parametric values can be found in Chapter 2 of the Motorola High-Speed CMOS Data Book (DL129/D).

C <sub>PD</sub>	Power Dissipation Capacitance (Per Gate)*	Typical @ 25°C, V <sub>CC</sub> = 5.0 V		pF
		25		

\* Used to determine the no-load dynamic power consumption:  $P_D = C_{PD} V_{CC}^2 f + I_{CC} V_{CC}$ . For load considerations, see Chapter 2 of the Motorola High-Speed CMOS Data Book (DL129/D).

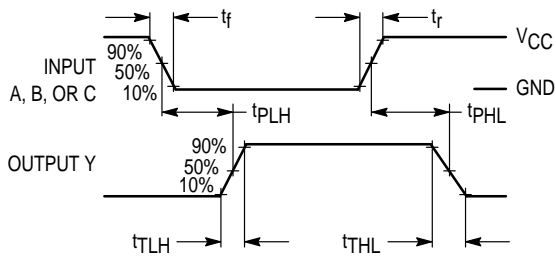
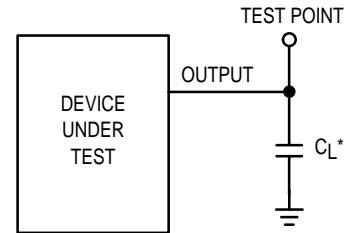

Figure 1. Switching Waveforms



\* Includes all probe and jig capacitance

Figure 2. Test Circuit

**EXPANDED LOGIC DIAGRAM  
(1/3 OF THE DEVICE)**

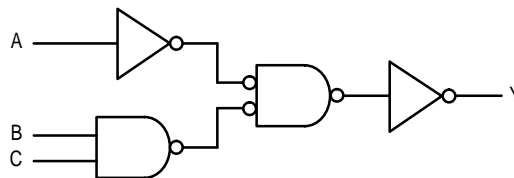

OUTLINE DIMENSIONS

**N SUFFIX**  
**PLASTIC DIP PACKAGE**  
 CASE 646-06  
 ISSUE L

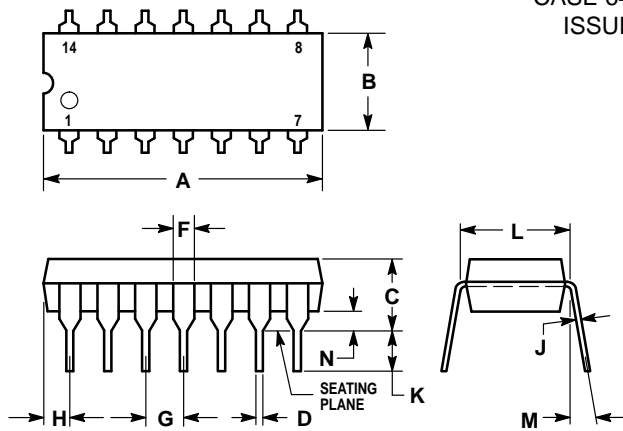

- NOTES:
- LEADS WITHIN 0.13 (0.005) RADIUS OF TRUE POSITION AT SEATING PLANE AT MAXIMUM MATERIAL CONDITION.
  - DIMENSION L TO CENTER OF LEADS WHEN FORMED PARALLEL.
  - DIMENSION B DOES NOT INCLUDE MOLD FLASH.
  - ROUNDED CORNERS OPTIONAL.

DIM	INCHES		MILLIMETERS	
	MIN	MAX	MIN	MAX
A	0.715	0.770	18.16	19.56
B	0.240	0.260	6.10	6.60
C	0.145	0.185	3.69	4.69
D	0.015	0.021	0.38	0.53
F	0.040	0.070	1.02	1.78
G	0.100 BSC		2.54 BSC	
H	0.052	0.095	1.32	2.41
J	0.008	0.015	0.20	0.38
K	0.115	0.135	2.92	3.43
L	0.300 BSC		7.62 BSC	
M	0°	10°	0°	10°
N	0.015	0.039	0.39	1.01

**D SUFFIX**  
**PLASTIC SOIC PACKAGE**  
 CASE 751A-03  
 ISSUE F

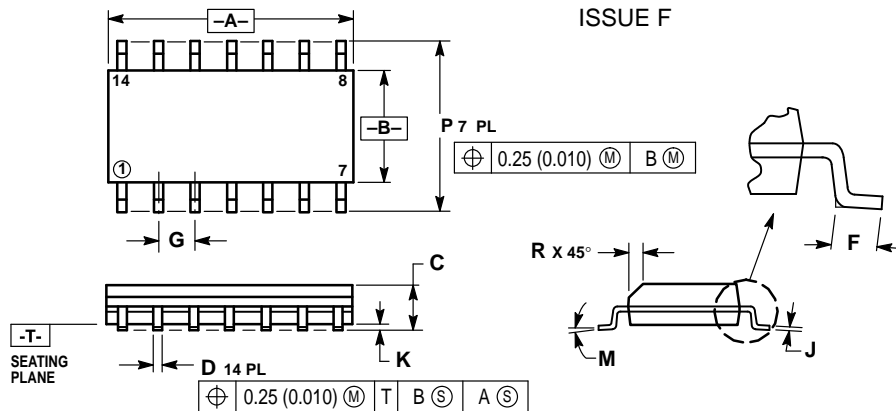

- NOTES:
- DIMENSIONING AND TOLERANCING PER ANSI Y14.5M, 1982.
  - CONTROLLING DIMENSION: MILLIMETER.
  - DIMENSIONS A AND B DO NOT INCLUDE MOLD PROTRUSION.
  - MAXIMUM MOLD PROTRUSION 0.15 (0.006) PER SIDE.
  - DIMENSION D DOES NOT INCLUDE DAMBAR PROTRUSION. ALLOWABLE DAMBAR PROTRUSION SHALL BE 0.127 (0.005) TOTAL IN EXCESS OF THE D DIMENSION AT MAXIMUM MATERIAL CONDITION.

DIM	MILLIMETERS		INCHES	
	MIN	MAX	MIN	MAX
A	8.55	8.75	0.337	0.344
B	3.80	4.00	0.150	0.157
C	1.35	1.75	0.054	0.068
D	0.35	0.49	0.014	0.019
F	0.40	1.25	0.016	0.049
G	1.27 BSC		0.050 BSC	
J	0.19	0.25	0.008	0.009
K	0.10	0.25	0.004	0.009
M	0°	7°	0°	7°
P	5.60	6.20	0.228	0.244
R	0.25	0.50	0.010	0.019

Motorola reserves the right to make changes without further notice to any products herein. Motorola makes no warranty, representation or guarantee regarding the suitability of its products for any particular purpose, nor does Motorola assume any liability arising out of the application or use of any product or circuit, and specifically disclaims any and all liability, including without limitation consequential or incidental damages. "Typical" parameters can and do vary in different applications. All operating parameters, including "Typicals" must be validated for each customer application by customer's technical experts. Motorola does not convey any license under its patent rights nor the rights of others. Motorola products are not designed, intended, or authorized for use as components in systems intended for surgical implant into the body, or other applications intended to support or sustain life, or for any other application in which the failure of the Motorola product could create a situation where personal injury or death may occur. Should Buyer purchase or use Motorola products for any such unintended or unauthorized application, Buyer shall indemnify and hold Motorola and its officers, employees, subsidiaries, affiliates, and distributors harmless against all claims, costs, damages, and expenses, and reasonable attorney fees arising out of, directly or indirectly, any claim of personal injury or death associated with such unintended or unauthorized use, even if such claim alleges that Motorola was negligent regarding the design or manufacture of the part. Motorola and <sup>™</sup> are registered trademarks of Motorola, Inc. Motorola, Inc. is an Equal Opportunity/Affirmative Action Employer.

**How to reach us:**

**USA/EUROPE:** Motorola Literature Distribution;  
 P.O. Box 20912; Phoenix, Arizona 85036. 1-800-441-2447

**JAPAN:** Nippon Motorola Ltd.; Tatsumi-SPD-JLDC, Toshikatsu Otsuki,  
 6F Seibu-Butsuryu-Center, 3-14-2 Tatsumi Koto-Ku, Tokyo 135, Japan. 03-3521-8315

**MFAX:** RMFAX0@email.sps.mot.com -TOUCHTONE (602) 244-6609  
**INTERNET:** http://Design-NET.com

**HONG KONG:** Motorola Semiconductors H.K. Ltd.; 8B Tai Ping Industrial Park,  
 51 Ting Kok Road, Tai Po, N.T., Hong Kong. 852-26629298

