

SINGLE-SUPPLY QUAD OPERATIONAL AMPLIFIER

■ GENERAL DESCRIPTION

The NJM324 consists of four independent, high gain, internally frequency compensated operational amplifiers which were designed specifically to operate from a single power supply over a wide range of voltages. Operation from split power supplies is also possible and the low power supply current drain is independent of the magnitude of the power supply voltage.

Application areas include transducer amplifiers, DC gain blocks and all the conventional op amp circuits which now can be more easily implemented in single power supply systems. For example, the NJM324 can be directly operated off of the standard $+5V_{DC}$ power supply voltage which is used in digital systems and will easily provide the required interface electronics without requiring the additional $\pm 15V_{DC}$ power supplies.

■ PACKAGE OUTLINE

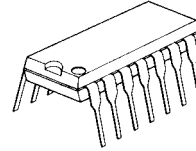

NJM324D

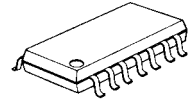

NJM324M

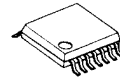

NJM324V

■ FEATURES

- Single Supply Operation
- Operating Voltage (+3V~+32V)
- Low Operating Current (0.7mA typ.)
- Package Outline DIP14,DMP14,SSOP14
- Bipolar Technology

■ PIN CONFIGURATION

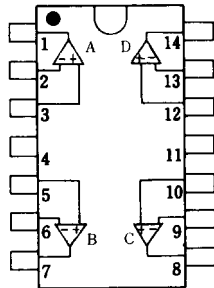

NJM324D
NJM324M
NJM324V

PIN FUNCTION

- 1. A OUTPUT
- 2. A -INPUT
- 3. A +INPUT
- 4. V^+
- 5. B +INPUT
- 6. B -INPUT
- 7. B OUTPUT
- 8. C OUTPUT
- 9. C -INPUT
- 10. C +INPUT
- 11. GND
- 12. D +INPUT
- 13. D -INPUT
- 14. D OUTPUT

■ EQUIVALENT CIRCUIT (1/4 Shown)

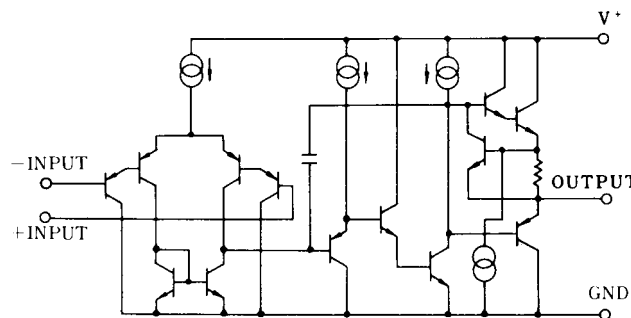

NJM324

■ ABSOLUTE MAXIMUM RATINGS

(Ta=25°C)

PARAMETER	SYMBOL	RATINGS	UNIT
Supply Voltage	V^+ / V^-	32 (or ± 16)	V
Differential Input Voltage	V_{ID}	32	V
Input Voltage	V_{IC}	-0.3~+32	V
Power Dissipation	P_D	(DIP14) 570 (DMP14) 300 (SSOP14) 300	mW
Operating Temperature Range	T_{opr}	-40~+85	°C
Storage Temperature Range	T_{stg}	-40~+125	°C

■ ELECTRICAL CHARACTERISTICS

(Ta=+25°C, $V^+=5V$)

PARAMETER	SYMBOL	TEST CONDITION	MIN.	TYP.	MAX.	UNIT
Input Offset Voltage	V_{IO}	$R_S=0\Omega, V^+=5\sim 30V_{DC}$	-	2	7	mV
Input Offset Current	I_{IO}		-	5	50	nA
Input Bias Current	I_B		-	20	250	nA
Input Common Mode Voltage Range	V_{ICM}		0~3.5	-	-	V
Operating Current	I_{OC}	$R_L=\infty$	-	0.7	1.2	mA
Large-signal Voltage Gain	A_V	$R_L \geq 2k\Omega, V^+=15V$	88	100	-	dB
Maximum Peak-to-peak Output Voltage Swing	V_{OPP}	$R_L=2k\Omega$	3.5	-	-	V
Common Mode Rejection Ratio	CMR	DC	65	70	-	dB
Supply Voltage Rejection Ratio	SVR	DC	65	100	-	dB
Output Source Current	I_{SOURCE}	$V_{IN}^+ / V_{IN}^- = 1/0V, V^+=15V$	20	40	-	mA
Output Sink Current 1	I_{SINK1}	$V_{IN}^+ / V_{IN}^- = 0/1V, V^+=15V$	10	20	-	mA
Output Sink Current 2	I_{SINK2}	$V_{IN}^+ / V_{IN}^- = 0/1V, V_o=200mV$	12	50	-	μA
Channel Separation	CS	$f=1kHz\sim 20kHz, \text{Input Referred}$	-	120	-	dB

■ TYPICAL CHARACTERISTICS

Voltage Gain, Phase vs. Frequency

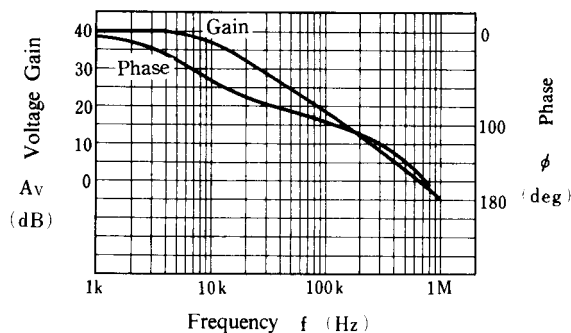

Output Sink Current

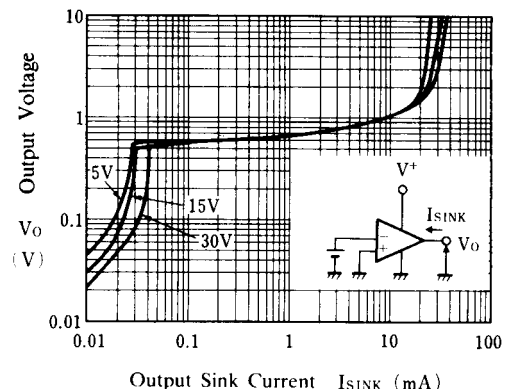

Output Source Current

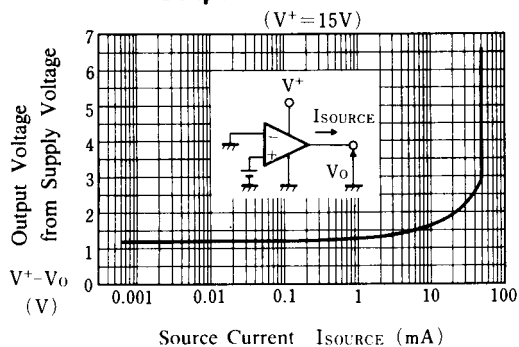

Maximum Output Voltage Swing vs. Frequency

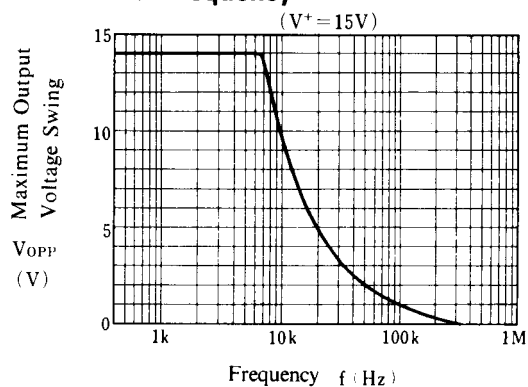

Maximum Output Voltage Swing vs. Load Resistance

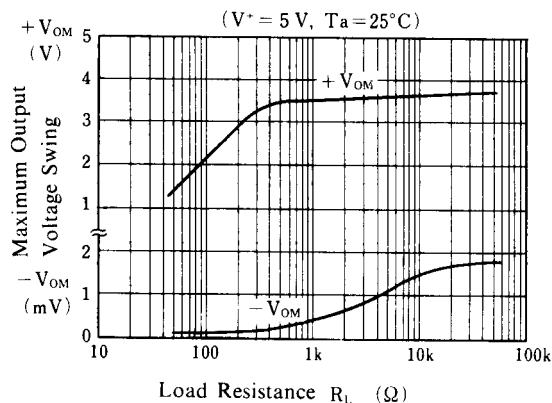

Pulse Response

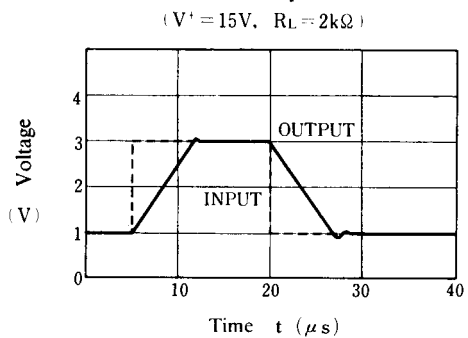

■ TYPICAL CHARACTERISTICS

Input Offset Voltage vs. Temperature

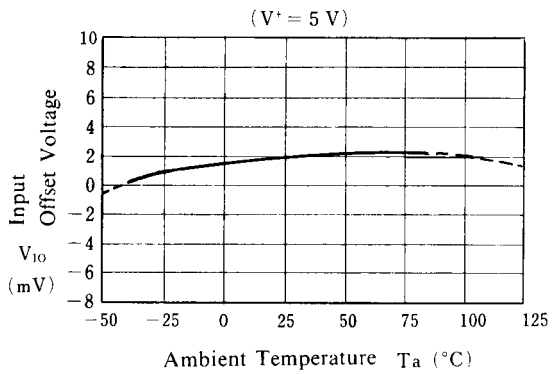

Input Bias Current vs. Temperature

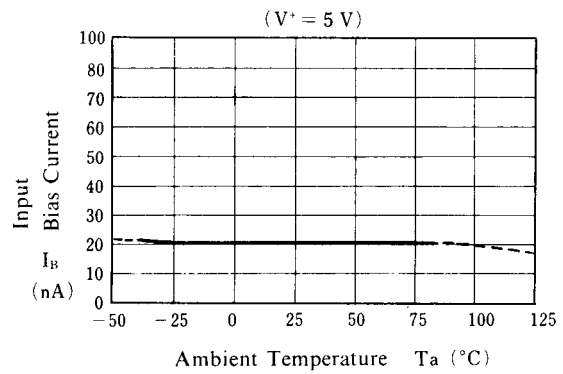

Operating Current vs. Temperature

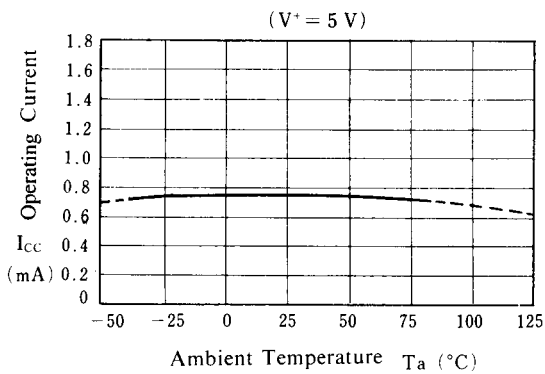

Maximum Output Voltage Swing vs. Temperature

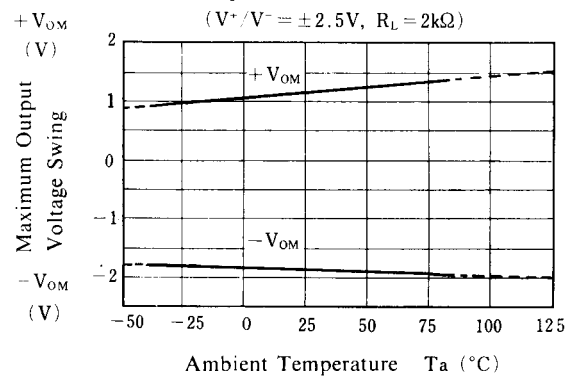

Output Sink Current 1 vs. Temperature

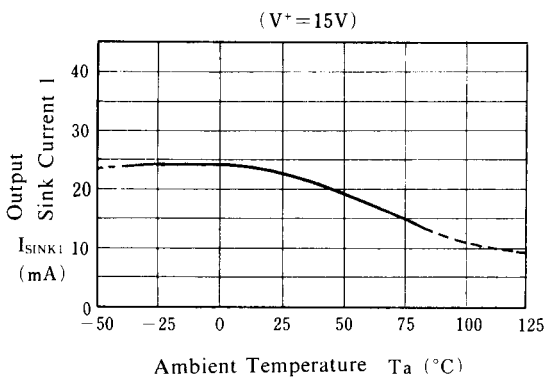

Output Sink Current 2 vs. Temperature

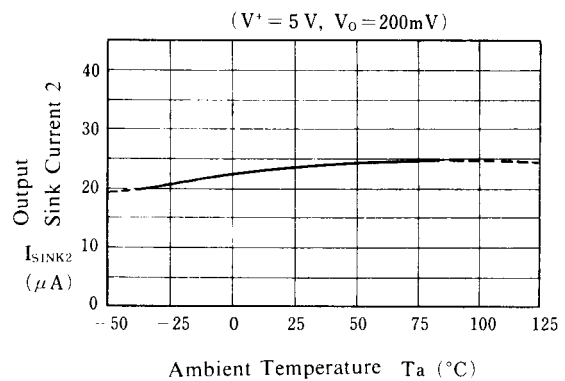

■ TYPICAL CHARACTERISTICS

Output Source Current vs. Temperature

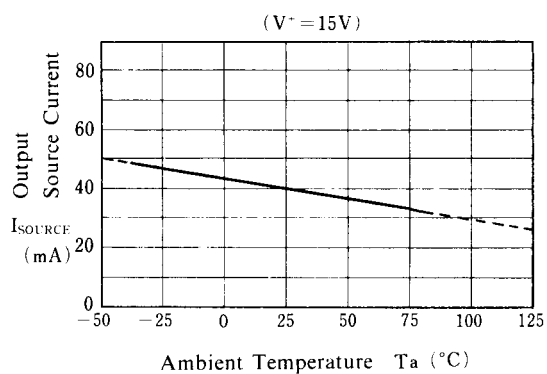

Operating Current vs. Operating Voltage

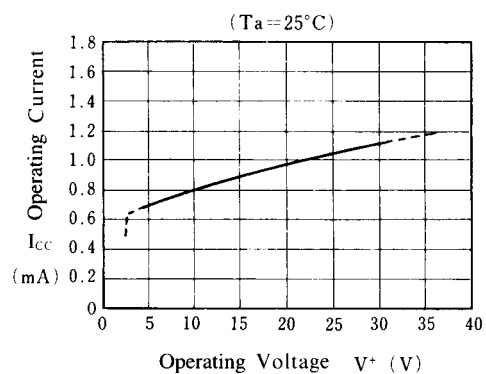

Maximum Output Voltage Swing vs. Operating Voltage

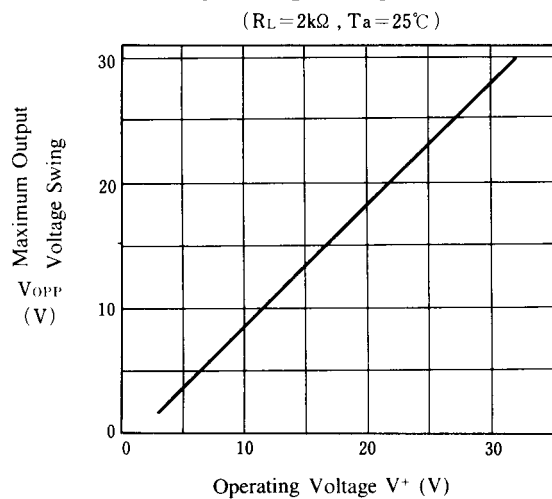

[CAUTION]

The specifications on this databook are only given for information, without any guarantee as regards either mistakes or omissions. The application circuits in this databook are described only to show representative usages of the product and not intended for the guarantee or permission of any right including the industrial rights.