

# Advanced Regulating Pulse Width Modulators

## FEATURES

- Fully Interchangeable with Standard UC1524 Family
- Precision Reference Internally Trimmed to  $\pm 1\%$
- High-Performance Current Limit Function
- Under-Voltage Lockout with Hysteretic Turn-on
- Start-Up Supply Current Less Than 4mA
- Output Current to 200mA
- 60V Output Capability
- Wide Common-Mode Input Range for both Error and Current Limit Amplifiers
- PWM Latch Insures Single Pulse per Period
- Double Pulse Suppression Logic
- 200ns Shutdown through PWM Latch
- Guaranteed Frequency Accuracy
- Thermal Shutdown Protection

## DESCRIPTION

The UC1524A family of regulating PWM ICs has been designed to retain the same highly versatile architecture of the industry standard UC1524 (SG1524) while offering substantial improvements to many of its limitations. The UC1524A is pin compatible with "non-A" models and in most existing applications can be directly interchanged with no effect on power supply performance. Using the UC1524A, however, frees the designer from many concerns which typically had required additional circuitry to solve.

The UC1524A includes a precise 5V reference trimmed to  $\pm 1\%$  accuracy, eliminating the need for potentiometer adjustments; an error amplifier with an input range which includes 5V, eliminating the need for a reference divider; a current sense amplifier useful in either the ground or power supply output lines; and a pair of 60V, 200mA uncommitted transistor switches which greatly enhance output versatility.

An additional feature of the UC1524A is an under-voltage lockout circuit which disables all the internal circuitry, except the reference, until the input voltage has risen to 8V. This holds standby current low until turn-on, greatly simplifying the design of low power, off-line supplies. The turn-on circuit has approximately 600mV of hysteresis for jitter-free activation.

Other product enhancements included in the UC1524A's design include a PWM latch which insures freedom from multiple pulsing within a period, even in noisy environments, logic to eliminate double pulsing on a single output, a 200ns external shutdown capability, and automatic thermal protection from excessive chip temperature. The oscillator circuit of the UC1524A is usable beyond 500kHz and is now easier to synchronize with an external clock pulse.

The UC1524A is packaged in a hermetic 16-pin DIP and is rated for operation from  $-55^{\circ}\text{C}$  to  $+125^{\circ}\text{C}$ . The UC2524A and 3524A are available in either ceramic or plastic packages and are rated for operation from  $-25^{\circ}\text{C}$  to  $+85^{\circ}\text{C}$  and  $0^{\circ}\text{C}$  to  $70^{\circ}\text{C}$ , respectively. Surface mount devices are also available.

## BLOCK DIAGRAM

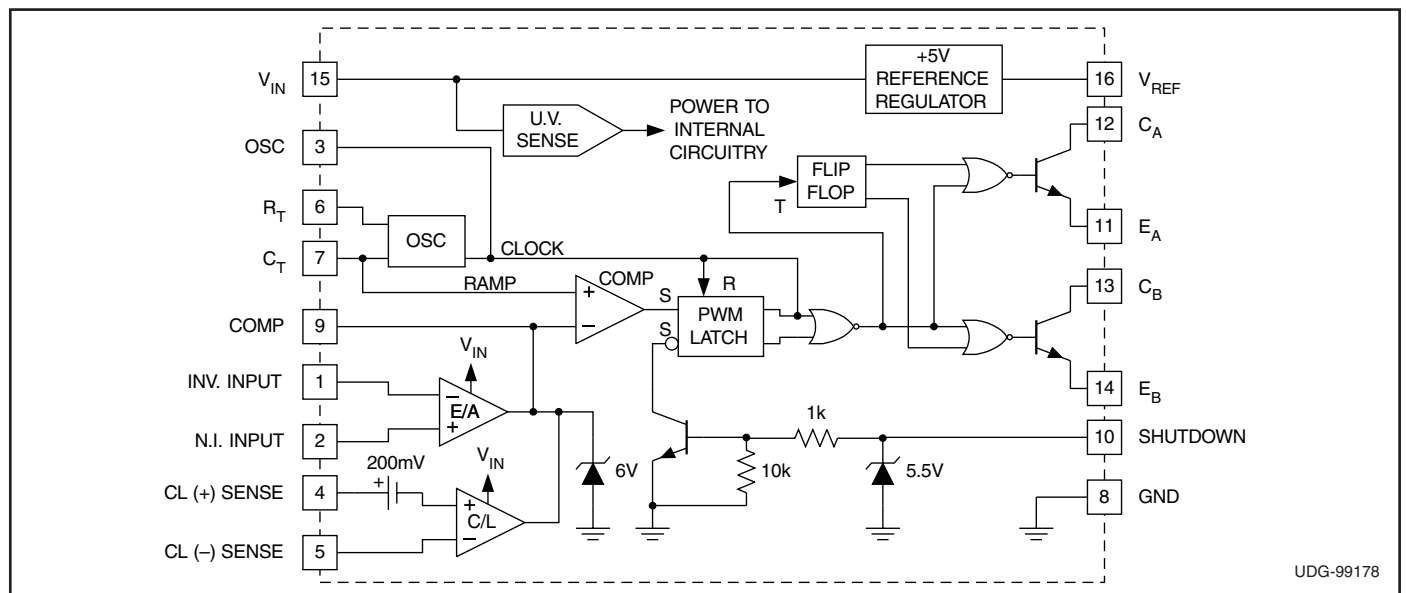

**ABSOLUTE MAXIMUM RATINGS**

Supply Voltage (VIN) . . . . . 40V  
 Collector Supply Voltage (Vc) . . . . . 60V  
 Output Current (each Output) . . . . . 200mA  
 Maximum Forced Voltage (Pin 9, 10) . . . . . -3 to +5V  
 Maximum Forced Current (Pin 9, 10) . . . . . ±10mA  
 Reference Output Current . . . . . 50mA  
 Oscillator Charging Current . . . . . 5mA  
 Power Dissipation at TA = +25°C . . . . . 1000mW  
 Power Dissipation at Tc = +25°C . . . . . 2000mW  
 Operating Temperature Range . . . . . -55°C to +125°C  
 Storage Temperature Range . . . . . -65°C to +150°C  
 Lead Temperature, (Soldering, 10 seconds) . . . . . +300°C  
*Note: Consult packaging section of Databook for thermal limitations and considerations of package.*

**CONNECTION DIAGRAMS**

**PLCC-20, LCC-20 (TOP VIEW)  
Q or L Package**

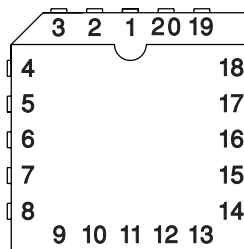

PACKAGE PIN FUNCTION	
FUNCTION	PIN
N/C	1
Inv. Input	2
Non-Inv. Input	3
OSC/SYNC	4
C.L. (+) sense	5
N/C	6
C.L. (-) sense	7
RT	8
CT	9
Ground	10
N/C	11
Compensation	12
Shutdown	13
Emitter A	14
Collector A	15
N/C	16
Collector B	17
Emitter B	18
+VIN	19
+5V VREF	20

**DIL-16, SOIC-16 (TOP VIEW)  
J or N Package, DW Package**

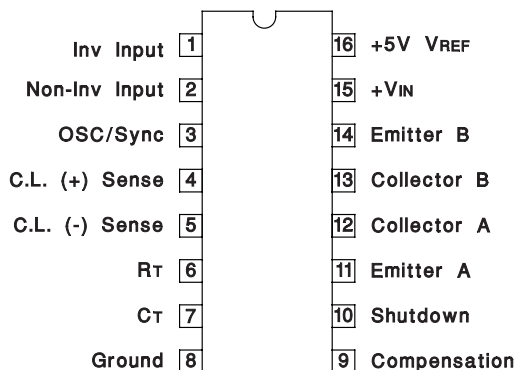

**ELECTRICAL CHARACTERISTICS:** Unless otherwise stated, these specifications apply for TA = -55°C to +125°C for the UC1524A, -25° to +85°C for the UC2524A, and 0°C to + 70°C for the UC3524A; VIN = Vc = 20V, TA = TJ.

PARAMETER	TEST CONDITIONS	UC1524A / UC2524A			UC3524A			UNITS
		MIN	TYP	MAX	MIN	TYP	MAX	
<b>Turn-on Characteristics</b>								
Input Voltage	Operating Range after Turn-on	8		40	8		40	V
Turn-on Threshold		6.5	7.5	8.5	6.5	7.5	8.5	V
Turn-on Current	VIN = 6V		2.5	4		2.5	4	mA
Operating Current	VIN = 8 to 40V		5	10		5	10	mA
Turn-on Hysteresis*			0.5			0.5		V
<b>Reference Section</b>								
Output Voltage	TJ = 25°C	4.95	5.00	5.05	4.90	5.00	5.10	V
	Over Operating Range	4.9		5.1	4.85		5.15	V
Line Regulation	VIN = 10 to 40V		10	20		10	30	mV
Load Regulation	IL = 0 to 20 mA		20	25		20	35	mV
Temperature Stability*	Over Operating Range*		20	25		20	35	mV
Short Circuit Current	VREF = 0, 25°C ≤ TJ ≤ 125°C		80	100		80	100	mA
Output Noise Voltage*	10Hz ≤ f ≤ 10kHz, TJ = 25°C		40			40		µVrms
Long Term Stability*	TJ = 125°C, 1000 Hrs.		20	50		20	50	mV

\* These parameters are guaranteed by design but not 100% tested in production.

**ELECTRICAL CHARACTERISTICS:** Unless otherwise stated, these specifications apply for  $T_A = -55^{\circ}\text{C}$  to  $+125^{\circ}\text{C}$  for the UC1524A,  $-25^{\circ}$  to  $+85^{\circ}\text{C}$  for the UC2524A, and  $0^{\circ}\text{C}$  to  $+70^{\circ}\text{C}$  for the UC3524A;  $V_{IN} = V_C = 20\text{V}$ ,  $T_A = T_J$ .

PARAMETER	TEST CONDITIONS	UC1524A / UC2524A			UC3524A			UNITS
		MIN	TYP	MAX	MIN	TYP	MAX	
<b>Oscillator Section</b> (Unless otherwise specified, $R_T = 2700\Omega$ , $C_T = 0.01\text{ mfd}$ )								
Initial Accuracy	$T_J = 25^{\circ}\text{C}$	41	43	45	39	43	47	kHz
	Over Operating Range	40.2		45.9	38.2		47.9	kHz
Temperature Stability*	Over Operating Temperature Range		1	2		1	2	%
Minimum Frequency	$R_T = 150\text{k}\Omega$ , $C_T = 0.1\text{ mfd}$			140			120	Hz
Maximum Frequency	$R_T = 2.0\text{k}\Omega$ , $C_T = 470\text{pF}$	500			500			kHz
Output Amplitude*		3	3.5		3	3.5		V
Output Pulse Width*		0.29	0.5	1.0	0.3	0.5	1.0	$\mu\text{s}$
Ramp Peak		3.3	3.5	3.7	3.3	3.5	3.7	V
Ramp Valley	$T_J = 25^{\circ}\text{C}$	0.7	0.8	0.9	0.7	0.8	0.9	V
Ramp Valley T.C.			-1.0			-1.0		$\text{mV}/^{\circ}\text{C}$
<b>Error Amplifier Section</b> (Unless otherwise specified, $V_{CM} = 2.5\text{V}$ )								
Input Offset Voltage			0.5	5		2	10	mV
Input Bias Current			1	5		1	10	$\mu\text{A}$
Input Offset Current			.05	1		0.5	1	$\mu\text{A}$
Common Mode Rejection Ratio	$V_{CM} = 1.5$ to $5.5\text{V}$	70	80		70	80		dB
Power Supply Rejection Ratio	$V_{IN} = 10$ to $40\text{V}$	70	80		70	80		dB
Output Swing (Note 1)		5.0		0.5	5.0		0.5	V
Open Loop Voltage Gain	$\Delta V_O = 1$ to $4\text{V}$ , $R_L \geq 10\text{M}\Omega$	72	80		64	80		dB
Gain-Bandwidth*	$T_J = 25^{\circ}\text{C}$ , $A_V = 0\text{dB}$	1	3		1	3		MHz
DC Transconductance*§	$T_J = 25^{\circ}\text{C}$ , $30\text{k}\Omega \leq R_L \leq 1\text{M}\Omega$	1.7	2.3		1.7	2.3		mS
<b>P.W.M. Comparator</b> ( $R_T = 2\text{k}\Omega$ , $C_T = 0.01\text{ mfd}$ )								
Minimum Duty Cycle	$V_{COMP} = 0.5\text{V}$			0			0	%
Maximum Duty Cycle	$V_{COMP} = 3.8\text{V}$	45			45			%
<b>Current Limit Amplifier</b> (Unless otherwise specified, Pin 5 = 0V)								
Input Offset Voltage	$T_J = 25^{\circ}\text{C}$ , E/A Set for Maximum Output	190	200	210	180	200	220	mV
	Over Operating Temperature Range	180		220	170		230	mV
Input Bias Current			-1	-10		-1	-10	$\mu\text{A}$
Common Mode Rejection Ratio	$V_{(\text{pin } 5)} = -0.3\text{V}$ to $+5.5\text{V}$	50	60		50	60		dB
Power Supply Rejection Ratio	$V_{IN} = 10$ to $40\text{V}$	50	60		50	60		dB
Output Swing (Note 1)	Minimum Total Range	5.0		0.5	5.0		0.5	V
Open-Loop Voltage Gain	$\Delta V_O = 1$ to $4\text{V}$ , $R_L \geq 10\text{M}\Omega$	70	80		70	80		dB
Delay Time*	Pin 4 to Pin 9, $\Delta V_{IN} = 300\text{mV}$		300			300		ns
<b>Output Section</b> (Each Output)								
Collector Emitter Voltage	$I_C = 100\mu\text{A}$	60	80		60	80		V
Collector Leakage Current	$V_{CE} = 50\text{V}$		.1	20		.1	20	$\mu\text{A}$

\* These parameters are guaranteed by design but not 100% tested in production.

§ DC transconductance ( $gm$ ) relates to DC open-loop voltage gain according to the following equation:  $A_V = gmR_L$  where  $R_L$  is the resistance from pin 9 to the common mode voltage.

The minimum  $gm$  specification is used to calculate minimum  $A_V$  when the error amplifier output is loaded.

Note 1: Min Limit applies to output high level, max limit applies to output low level.

**ELECTRICAL CHARACTERISTICS:** Unless otherwise stated, these specifications apply for  $T_A = -55^{\circ}\text{C}$  to  $+125^{\circ}\text{C}$  for the UC1524A,  $-25^{\circ}$  to  $+85^{\circ}\text{C}$  for the UC2524A, and  $0^{\circ}\text{C}$  to  $+70^{\circ}\text{C}$  for the UC3524A;  $V_{IN} = V_C = 20\text{V}$ .  $T_A = T_J$ .

PARAMETER	TEST CONDITIONS	UC1524A / UC2524A			UC3524A			UNITS
		MIN	TYP	MAX	MIN	TYP	MAX	
<b>Output Section ( cont.)</b> (Each Output)								
Saturation Voltage	$I_C = 20\text{mA}$ $I_C = 200\text{mA}$		.2 1	.4 2.2		.2 1	.4 2.2	V V
Emitter Output Voltage	$I_E = 50\text{mA}$	17	18		17	18		V
Rise Time*	$T_J = 25^{\circ}\text{C}$ , $R = 2\text{k}\Omega$		120	400		120	400	ns
Fall Time*	$T_J = 25^{\circ}\text{C}$ , $R = 2\text{k}\Omega$		25	200		25	200	ns
Comparator Delay*	$T_J = 25^{\circ}\text{C}$ , Pin 9 to output		300			300		ns
Shutdown Delay*	$T_J = 25^{\circ}\text{C}$ , Pin 10 to output		200			200		ns
Shutdown Threshold	$T_J = 25^{\circ}\text{C}$ , $R_C = 2\text{k}\Omega$	0.6	.7	1.0	0.6	.7	1.0	V
S/D Threshold Over Temp.	Over Operating Temperature Range	0.4		1.2	0.4		1.0	V
Thermal Shutdown*			165			165		$^{\circ}\text{C}$

\* These parameters are guaranteed by design but not 100% tested in production.

## OPEN-LOOP CIRCUIT

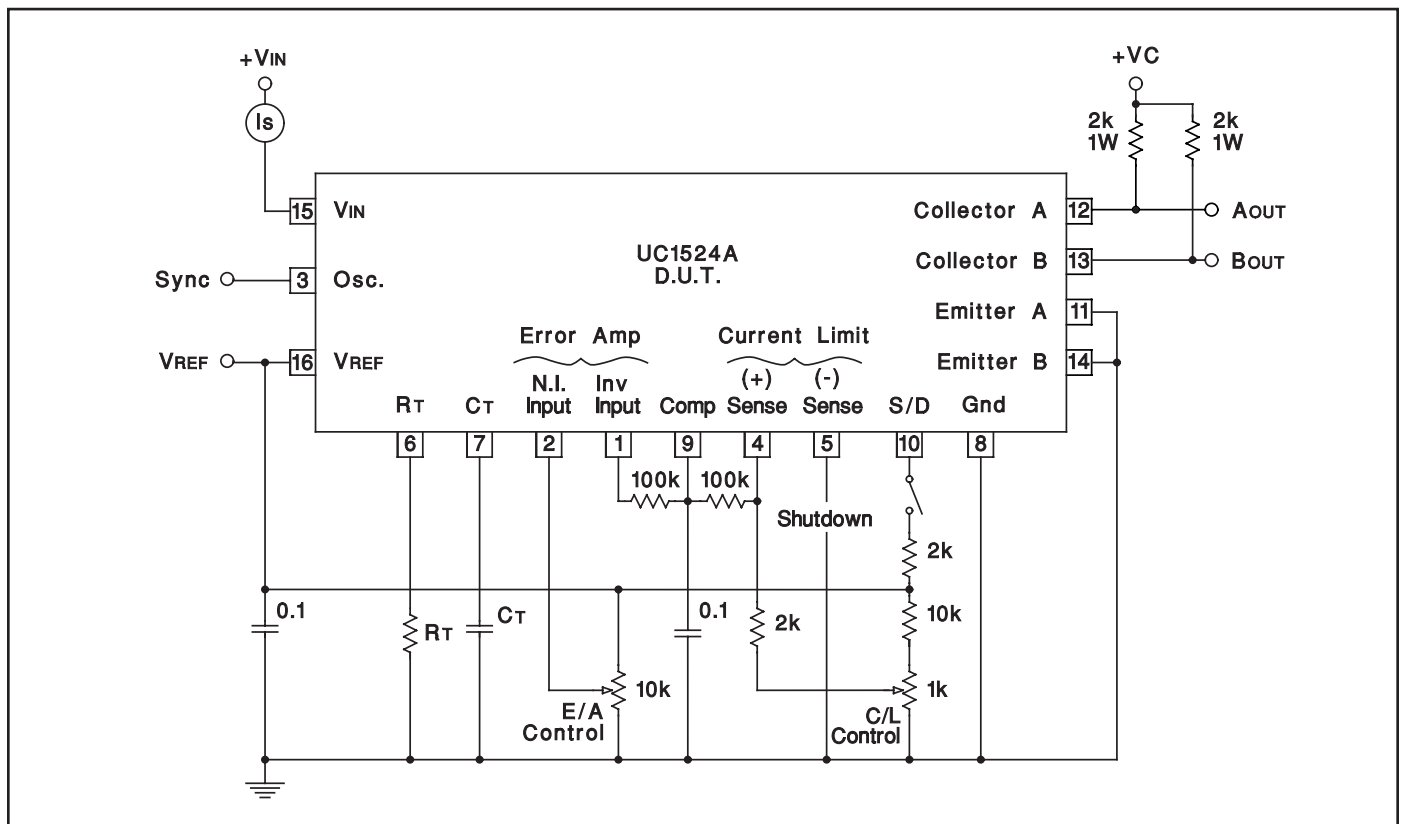

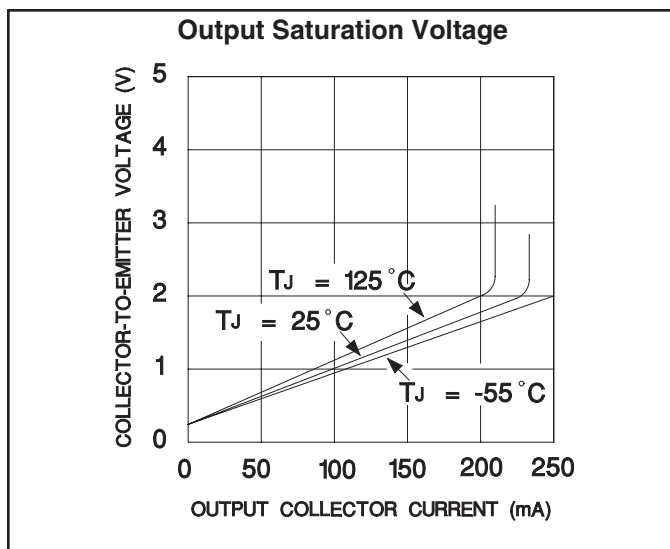
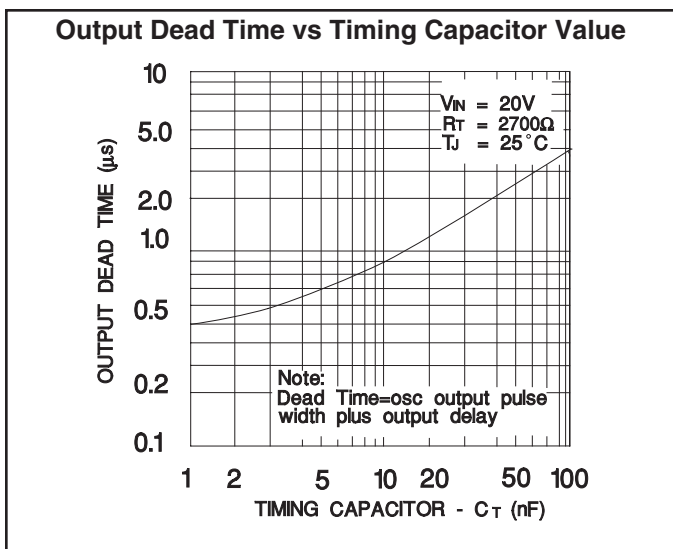
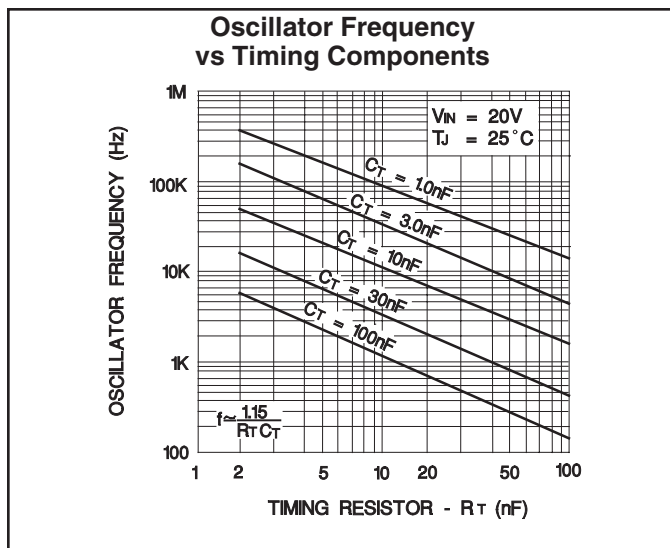
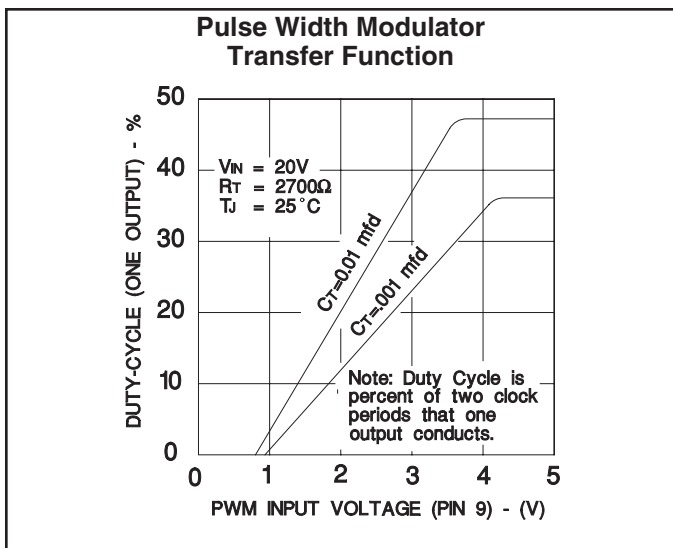
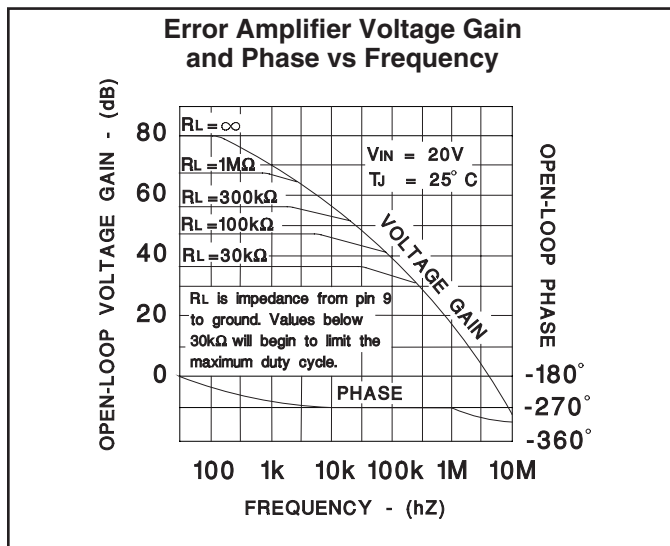
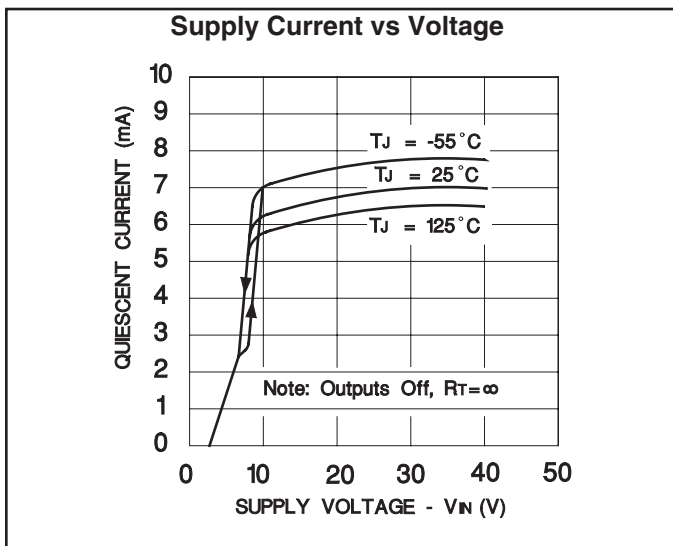

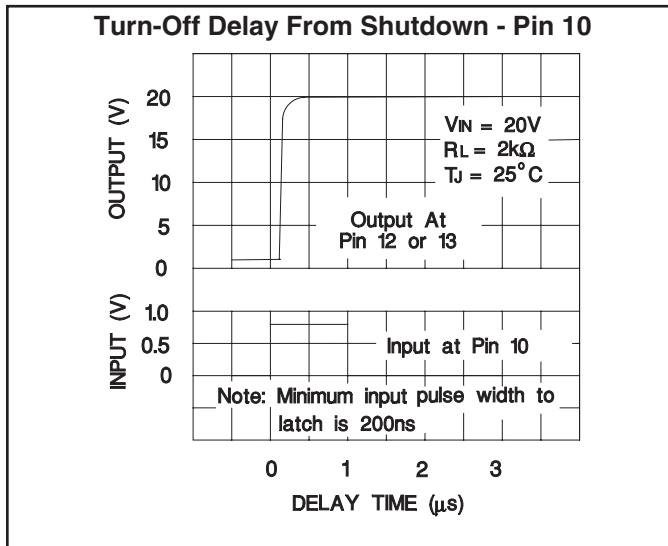
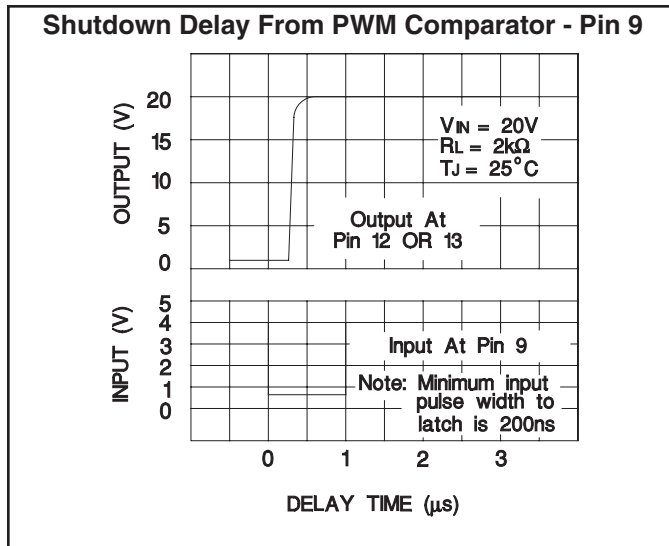
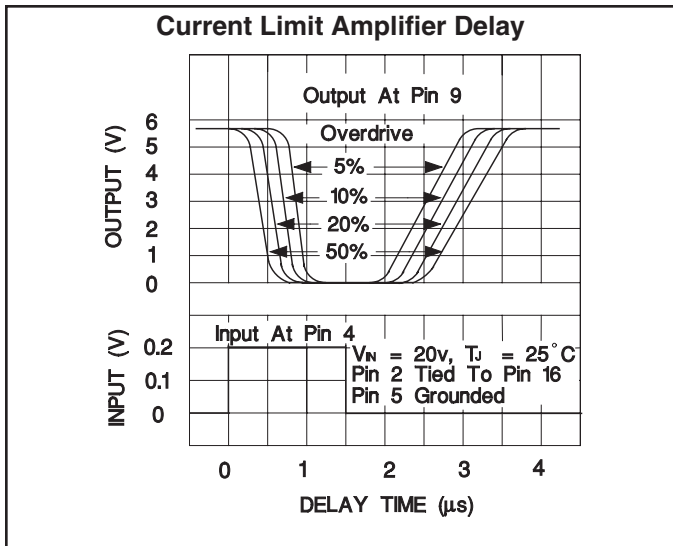

## **IMPORTANT NOTICE**

Texas Instruments and its subsidiaries (TI) reserve the right to make changes to their products or to discontinue any product or service without notice, and advise customers to obtain the latest version of relevant information to verify, before placing orders, that information being relied on is current and complete. All products are sold subject to the terms and conditions of sale supplied at the time of order acknowledgment, including those pertaining to warranty, patent infringement, and limitation of liability.

TI warrants performance of its semiconductor products to the specifications applicable at the time of sale in accordance with TI's standard warranty. Testing and other quality control techniques are utilized to the extent TI deems necessary to support this warranty. Specific testing of all parameters of each device is not necessarily performed, except those mandated by government requirements.

Customers are responsible for their applications using TI components.

In order to minimize risks associated with the customer's applications, adequate design and operating safeguards must be provided by the customer to minimize inherent or procedural hazards.

TI assumes no liability for applications assistance or customer product design. TI does not warrant or represent that any license, either express or implied, is granted under any patent right, copyright, mask work right, or other intellectual property right of TI covering or relating to any combination, machine, or process in which such semiconductor products or services might be or are used. TI's publication of information regarding any third party's products or services does not constitute TI's approval, warranty or endorsement thereof.