

ohne / without

Durchgangsloch $\phi 3,5$
through hole $\phi 3,5$

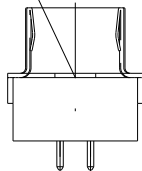

Mutter / nut :

Gewinde / thread
M3 / #4-40

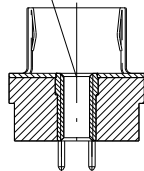

Bolzen / bolt :

Gewinde / thread
M3 / #4-40

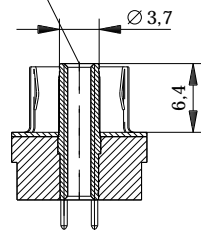

Bolzen / bolt :

Gewinde / thread
M3 - #4-40 /
#4-40 - M3

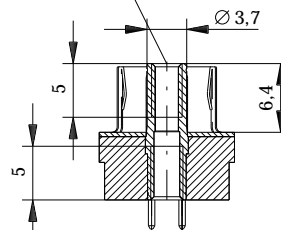

Anschlussbereich verzinkt
terminal area tin plating

Anforderungsstufe: 2
class: 2

214723	$\phi 3,5$			
214728			#4-40	
214727			M 3	
214726			#4-40-M3	
214725		#4-40		
214724		M 3		
Ident-Nr part-no.	ohne without	Mutter thread	Bolzen bolt	Bemerkung remark

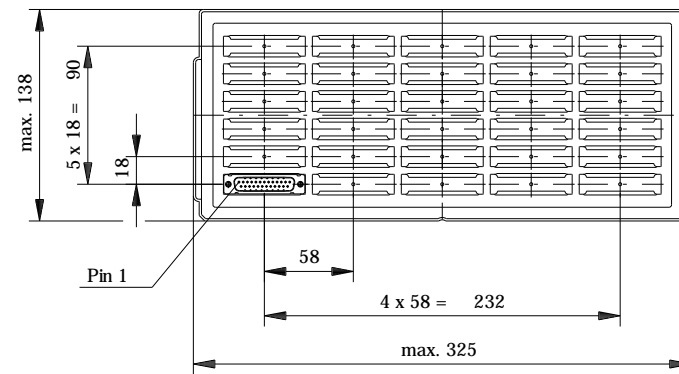

Verpackt in Tray
Verpackungseinheit 30 St.
tray packaging
packaging unit 30 pcs

Layout:

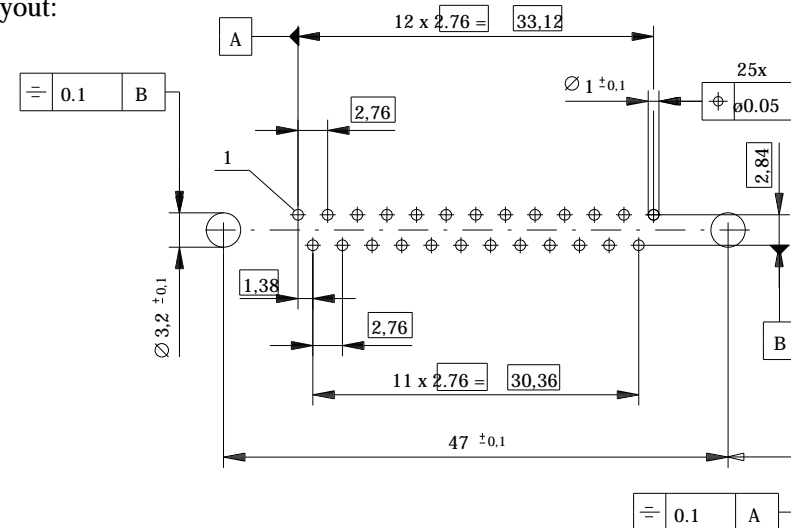



Fehlende Masse und Angaben siehe DIN 41652 /

Missing information and dimensions according to DIN 41652

Sonstige Angaben siehe Fertigungsunterlagen /

Additional indications please see the production documentation

Information:	Tolerances  All Dimensions in mm	Scale 2:1
All rights reserved. Only for information. To insure that this is the latest version of this drawing, please contact one of the ERNI companies before using.	Subject to modification without prior notice. Drawing will not be updated.	Designation TMC-P 25-TLSV-2,7-6,3-BA8 TMC-P 25-TLSV-2,7-6,3-type 8
 www.ERNI.com	144992	1
Index	Date	H:00046164.SZA
		TMCP

Consider protection memo from DIN 94