

Silicon Controlled Rectifiers

Reverse Blocking Triode Thyristors

... Annular PNP devices designed for high volume consumer applications such as relay and lamp drivers, small motor controls, gate drivers for larger thyristors, and sensing and detection circuits. Supplied in an inexpensive plastic TO-226AA (TO-92) package which is readily adaptable for use in automatic insertion equipment.

- Sensitive Gate Trigger Current — 200 μ A Maximum
- Low Reverse and Forward Blocking Current — 50 μ A Maximum, $T_C = 125^\circ\text{C}$
- Low Holding Current — 5 mA Maximum
- Passivated Surface for Reliability and Uniformity

2N5060
2N5061
2N5062 *
2N5064 *

*Motorola preferred devices

SCRs
0.8 AMPERES RMS
30 thru 200 VOLTS

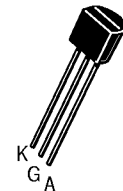

CASE 29-04
(TO-226AA)
STYLE 10

MAXIMUM RATINGS ($T_J = 25^\circ\text{C}$ unless otherwise noted.)

Rating	Symbol	Value	Unit
*Peak Repetitive Forward and Reverse Blocking Voltage ⁽¹⁾ ($T_J = 25$ to 125°C) ($R_{GK} = 1000$ ohms)	V_{DRM} or V_{RRM}	30 60 100 200	Volts
On-State Current RMS (All Conduction Angles)	$I_T(\text{RMS})$	0.8	Amp
*Average On-State Current ($T_C = 67^\circ\text{C}$) ($T_C = 102^\circ\text{C}$)	$I_T(\text{AV})$	0.51 0.255	Amp
*Peak Non-repetitive Surge Current, $T_A = 25^\circ\text{C}$ (1/2 cycle, Sine Wave, 60 Hz)	I_{TSM}	10	Amps
Circuit Fusing Considerations ($t = 8.3$ ms)	I^2t	0.4	A^2s
*Peak Gate Power, $T_A = 25^\circ\text{C}$	P_{GM}	0.1	Watt
*Average Gate Power, $T_A = 25^\circ\text{C}$	$P_{G(\text{AV})}$	0.01	Watt
*Peak Forward Gate Current, $T_A = 25^\circ\text{C}$ (300 μs , 120 PPS)	I_{FGM}	1	Amp
*Peak Reverse Gate Voltage	V_{RGM}	5	Volts

*Indicates JEDEC Registered Data.

(cont.)

1. V_{DRM} and V_{RRM} for all types can be applied on a continuous basis. Ratings apply for zero or negative gate voltage; however, positive gate voltage shall not be applied concurrent with negative potential on the anode. Blocking voltages shall not be tested with a constant current source such that the voltage ratings of the devices are exceeded.

Preferred devices are Motorola recommended choices for future use and best overall value.

REV 1



2N5060 2N5061 2N5062 2N5064

MAXIMUM RATINGS — continued

Rating	Symbol	Value	Unit
*Operating Junction Temperature Range @ Rated V_{RRM} and V_{DRM}	T_J	-65 to +125	°C
*Storage Temperature Range	T_{stg}	-65 to +150	°C
Lead Solder Temperature (Lead Length \geq 1/16 from case, 10 s Max)	—	+230	°C

THERMAL CHARACTERISTICS

Characteristic	Symbol	Max	Unit
*Thermal Resistance, Junction to Case ⁽¹⁾	$R_{\theta JC}$	75	°C/W
Thermal Resistance, Junction to Ambient	$R_{\theta JA}$	200	°C/W

ELECTRICAL CHARACTERISTICS ($T_C = 25^\circ\text{C}$, $R_{GK} = 1000 \Omega$ unless otherwise noted.), ⁽²⁾

Characteristic	Symbol	Min	Typ	Max	Unit
*Peak Repetitive Forward or Reverse Blocking Current ($V_{AK} = \text{Rated } V_{DRM} \text{ or } V_{RRM}$) $T_C = 25^\circ\text{C}$ $T_C = 125^\circ\text{C}$	I_{DRM}, I_{RRM}	— —	— —	10 50	μA μA
*Forward "On" Voltage ⁽³⁾ ($I_{TM} = 1.2 \text{ A peak @ } T_A = 25^\circ\text{C}$)	V_{TM}	—	—	1.7	Volts
Gate Trigger Current (Continuous dc) ⁽⁴⁾ *(Anode Voltage = 7 Vdc, $R_L = 100 \text{ Ohms}$) $T_C = 25^\circ\text{C}$ $T_C = -65^\circ\text{C}$	I_{GT}	— —	— —	200 350	μA
Gate Trigger Voltage (Continuous dc) *(Anode Voltage = 7 Vdc, $R_L = 100 \text{ Ohms}$) (Anode Voltage = Rated V_{DRM} , $R_L = 100 \text{ Ohms}$) $T_C = 25^\circ\text{C}$ $T_C = -65^\circ\text{C}$ $T_C = 125^\circ\text{C}$	V_{GT} V_{GD}	— 0.1	— —	0.8 —	Volts
Holding Current *(Anode Voltage = 7 Vdc, initiating current = 20 mA) $T_C = 25^\circ\text{C}$ $T_C = -65^\circ\text{C}$	I_H	— —	— —	5 10	mA
Turn-On Time Delay Time Rise Time ($I_{GT} = 1 \text{ mA}$, $V_D = \text{Rated } V_{DRM}$, Forward Current = 1 A, $di/dt = 6 \text{ A}/\mu\text{s}$)	t_d t_r	— —	3 0.2	— —	μs
Turn-Off Time (Forward Current = 1 A pulse, Pulse Width = 50 μs , 0.1% Duty Cycle, $di/dt = 6 \text{ A}/\mu\text{s}$, $dv/dt = 20 \text{ V}/\mu\text{s}$, $I_{GT} = 1 \text{ mA}$) 2N5060, 2N5061 2N5062, 5063, 5064	t_q	— —	10 30	— —	μs
Forward Voltage Application Rate (Rated V_{DRM} , Exponential)	dv/dt	—	30	—	$\text{V}/\mu\text{s}$

*Indicates JEDEC Registered Data.

1. This measurement is made with the case mounted "flat side down" on a heat sink and held in position by means of a metal clamp over the curved surface.
2. For electrical characteristics for gate-to-cathode resistance other than 1000 ohms see Motorola Bulletin EB-30.
3. Forward current applied for 1 ms maximum duration, duty cycle \leq 1%.
4. R_{GK} current is not included in measurement.

CURRENT DERATING

FIGURE 1 – MAXIMUM CASE TEMPERATURE

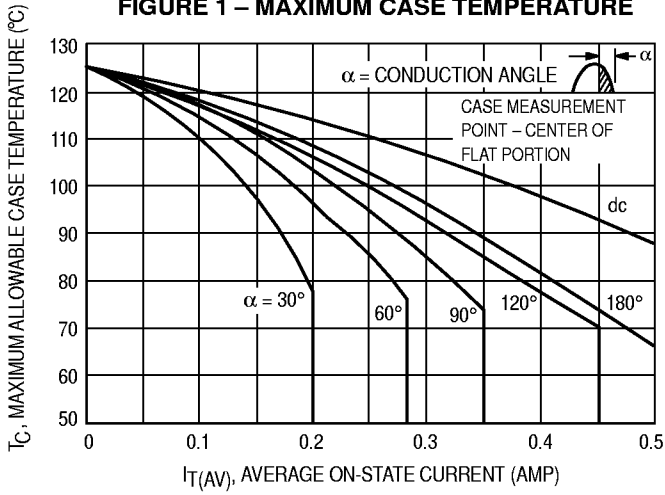

FIGURE 2 – MAXIMUM AMBIENT TEMPERATURE

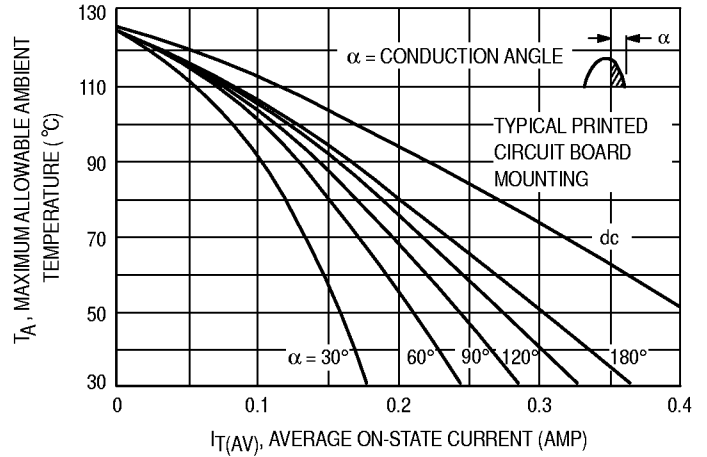

FIGURE 3 – TYPICAL FORWARD VOLTAGE

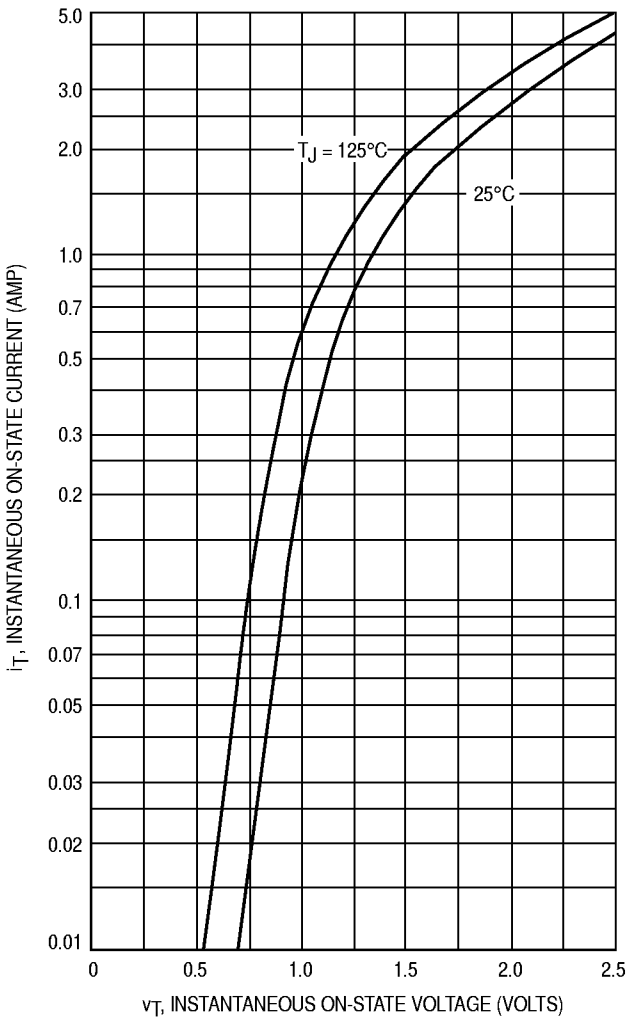

FIGURE 4 – MAXIMUM NON-REPETITIVE SURGE CURRENT

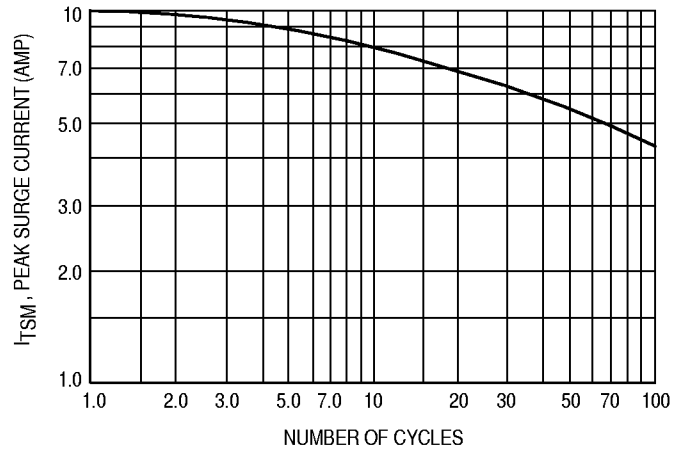

FIGURE 5 – POWER DISSIPATION

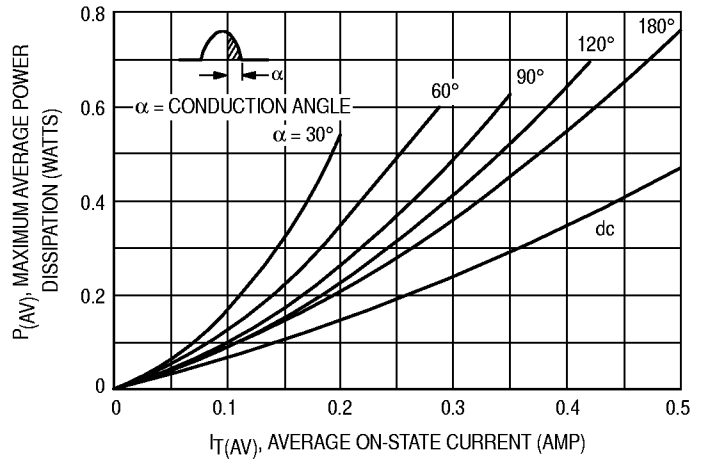
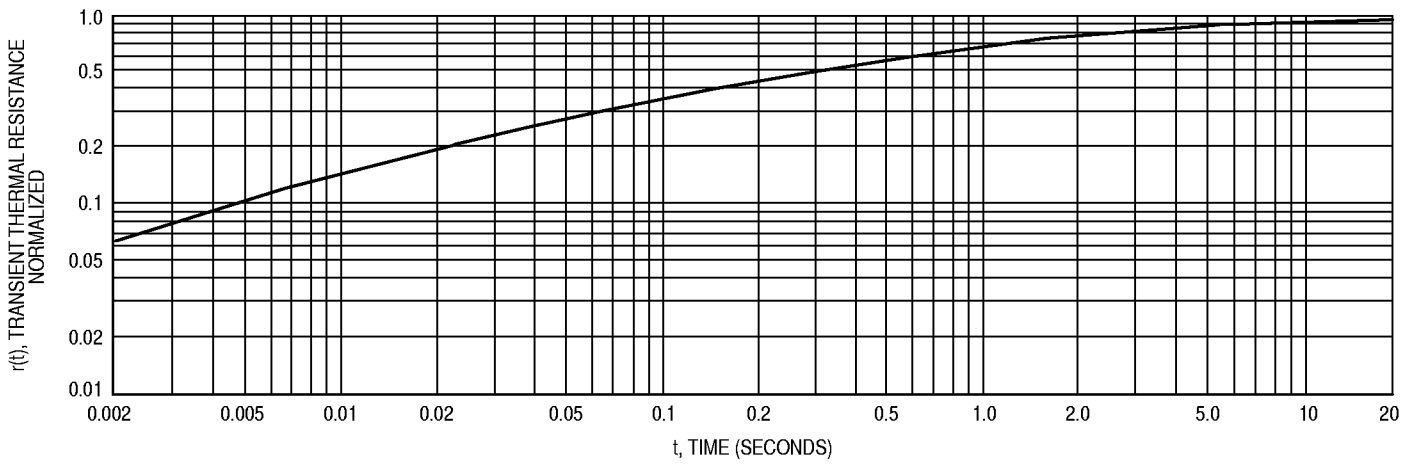

FIGURE 6 – THERMAL RESPONSE



TYPICAL CHARACTERISTICS

FIGURE 7 – GATE TRIGGER VOLTAGE

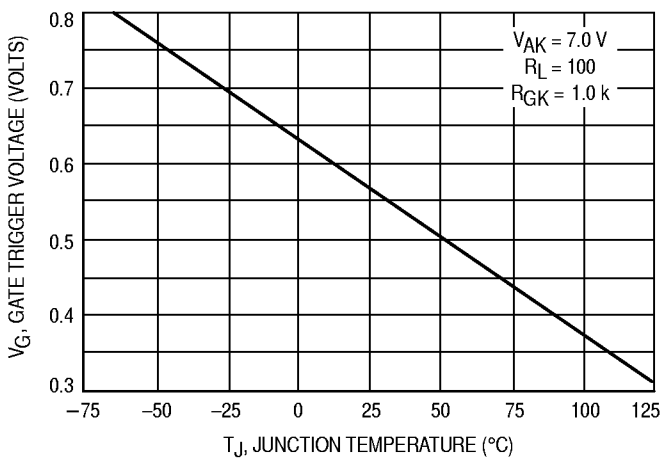

FIGURE 8 – GATE TRIGGER CURRENT

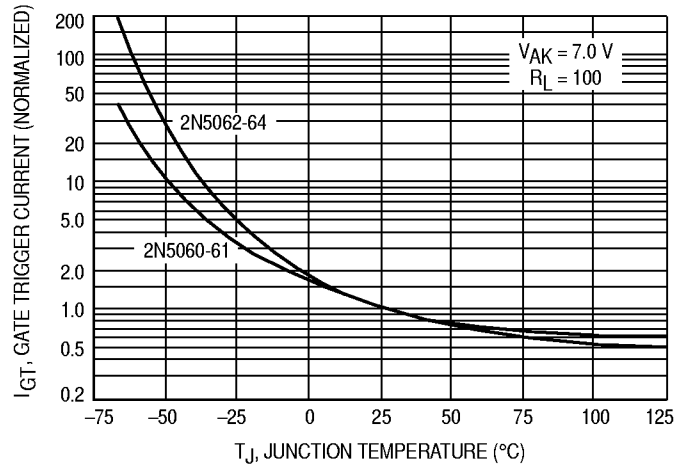

FIGURE 9 – HOLDING CURRENT

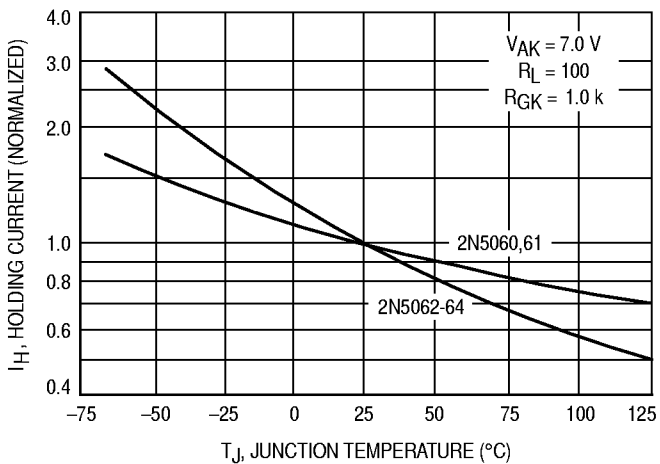
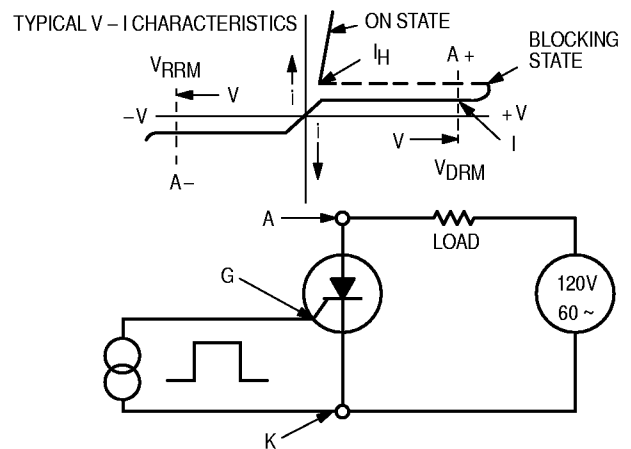
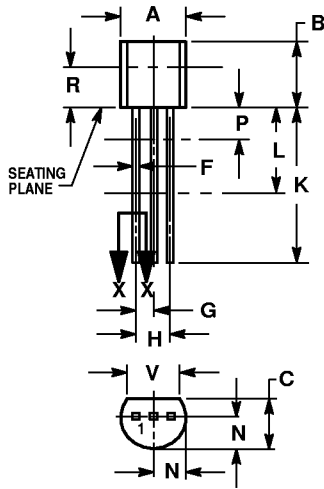

FIGURE 10 – CHARACTERISTICS AND SYMBOLS



PACKAGE DIMENSIONS



STYLE 10:
PIN 1. CATHODE
2. GATE
3. ANODE

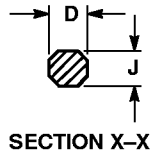

NOTES:

1. DIMENSIONING AND TOLERANCING PER ANSI Y14.5M, 1982.
2. CONTROLLING DIMENSION: INCH.
3. CONTOUR OF PACKAGE BEYOND DIMENSION R IS UNCONTROLLED.
4. DIMENSION F APPLIES BETWEEN P AND L. DIMENSION D AND J APPLY BETWEEN L AND K MINIMUM. LEAD DIMENSION IS UNCONTROLLED IN P AND BEYOND DIMENSION K MINIMUM.

DIM	INCHES		MILLIMETERS	
	MIN	MAX	MIN	MAX
A	0.175	0.205	4.45	5.20
B	0.170	0.210	4.32	5.33
C	0.125	0.165	3.18	4.19
D	0.016	0.022	0.41	0.55
F	0.016	0.019	0.41	0.48
G	0.045	0.055	1.15	1.39
H	0.095	0.105	2.42	2.66
J	0.015	0.020	0.39	0.50
K	0.500	—	12.70	—
L	0.250	—	6.35	—
N	0.080	0.105	2.04	2.66
P	—	0.100	—	2.54
R	0.115	—	2.93	—
V	0.135	—	3.43	—

CASE 029-04
(TO-226AA)