

TIC116 SERIES SILICON CONTROLLED RECTIFIERS

Copyright © 2000, Power Innovations Limited, UK

APRIL 1971 - REVISED JUNE 2000

- **8 A Continuous On-State Current**
- **80 A Surge-Current**
- **Glass Passivated Wafer**
- **400 V to 800 V Off-State Voltage**
- **Max I_{GT} of 20 mA**

TO-220 PACKAGE
(TOP VIEW)

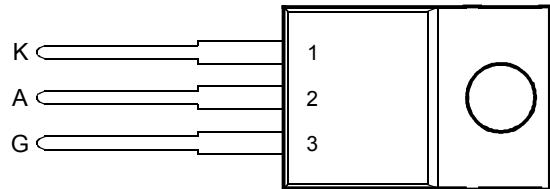

Pin 2 is in electrical contact with the mounting base.

MDC1ACA

absolute maximum ratings over operating case temperature (unless otherwise noted)

RATING		SYMBOL	VALUE	UNIT
Repetitive peak off-state voltage	TIC116D	V_{DRM}	400	V
	TIC116M		600	
	TIC116S		700	
	TIC116N		800	
Repetitive peak reverse voltage	TIC116D	V_{RRM}	400	V
	TIC116M		600	
	TIC116S		700	
	TIC116N		800	
Continuous on-state current at (or below) 70°C case temperature (see Note 1)		$I_{T(RMS)}$	8	A
Average on-state current (180° conduction angle) at (or below) 70°C case temperature (see Note 2)		$I_{T(AV)}$	5	A
Surge on-state current at (or below) 25°C case temperature (see Note 3)		I_{TM}	80	A
Peak positive gate current (pulse width $\leq 300 \mu s$)		I_{GM}	3	A
Peak gate power dissipation (pulse width $\leq 300 \mu s$)		P_{GM}	5	W
Average gate power dissipation (see Note 4)		$P_{G(AV)}$	1	W
Operating case temperature range		T_C	-40 to +110	°C
Storage temperature range		T_{stg}	-40 to +125	°C
Lead temperature 1.6 mm from case for 10 seconds		T_L	230	°C

- NOTES: 1. These values apply for continuous dc operation with resistive load. Above 70°C derate linearly to zero at 110°C.
 2. This value may be applied continuously under single phase 50 Hz half-sine-wave operation with resistive load. Above 70°C derate linearly to zero at 110°C.
 3. This value applies for one 50 Hz half-sine-wave when the device is operating at (or below) the rated value of peak reverse voltage and on-state current. Surge may be repeated after the device has returned to original thermal equilibrium.
 4. This value applies for a maximum averaging time of 20 ms.

PRODUCT INFORMATION

Information is current as of publication date. Products conform to specifications in accordance with the terms of Power Innovations standard warranty. Production processing does not necessarily include testing of all parameters.



TIC116 SERIES SILICON CONTROLLED RECTIFIERS

APRIL 1971 - REVISED JUNE 2000

electrical characteristics at 25°C case temperature (unless otherwise noted)

PARAMETER		TEST CONDITIONS			MIN	TYP	MAX	UNIT
I_{DRM}	Repetitive peak off-state current	$V_D = \text{rated } V_{DRM}$	$T_C = 110^\circ\text{C}$			2	mA	
I_{RRM}	Repetitive peak reverse current	$V_R = \text{rated } V_{RRM}$	$I_G = 0$	$T_C = 110^\circ\text{C}$		2	mA	
I_{GT}	Gate trigger current	$V_{AA} = 12\text{ V}$	$R_L = 100\ \Omega$	$t_{p(g)} \geq 20\ \mu\text{s}$		8	20	mA
V_{GT}	Gate trigger voltage	$V_{AA} = 12\text{ V}$	$R_L = 100\ \Omega$	$T_C = -40^\circ\text{C}$			2.5	V
		$V_{AA} = 12\text{ V}$	$R_L = 100\ \Omega$			0.8	1.5	
		$V_{AA} = 12\text{ V}$	$R_L = 100\ \Omega$	$T_C = 110^\circ\text{C}$	0.2			
I_H	Holding current	$V_{AA} = 12\text{ V}$	Initiating $I_T = 100\text{ mA}$	$T_C = -40^\circ\text{C}$			100	mA
		$V_{AA} = 12\text{ V}$	Initiating $I_T = 100\text{ mA}$				40	
V_T	On-state voltage	$I_T = 8\text{ A}$	(see Note 5)				1.7	V
dv/dt	Critical rate of rise of off-state voltage	$V_D = \text{rated } V_D$	$I_G = 0$	$T_C = 110^\circ\text{C}$		400		V/ μs

NOTE 5: This parameter must be measured using pulse techniques, $t_p = 300\ \mu\text{s}$, duty cycle $\leq 2\%$. Voltage sensing-contacts, separate from the current carrying contacts, are located within 3.2 mm from the device body.

thermal characteristics

PARAMETER		MIN	TYP	MAX	UNIT
$R_{\theta JC}$	Junction to case thermal resistance			3	$^\circ\text{C}/\text{W}$
$R_{\theta JA}$	Junction to free air thermal resistance			62.5	$^\circ\text{C}/\text{W}$

THERMAL INFORMATION

AVERAGE ON-STATE CURRENT
DERATING CURVE

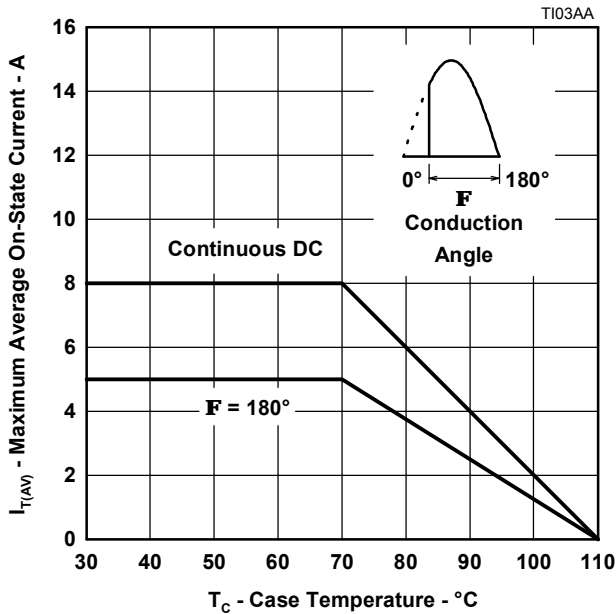

Figure 1.

MAX ANODE POWER LOSS
VS
ON-STATE CURRENT

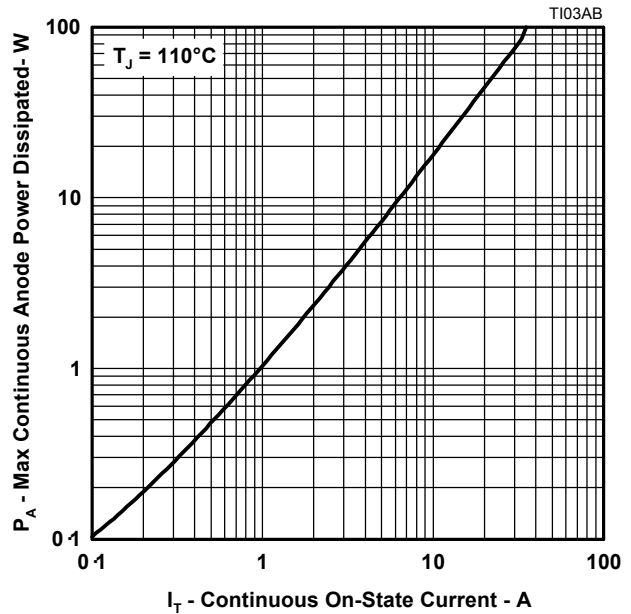

Figure 2.

SURGE ON-STATE CURRENT
VS
CYCLES OF CURRENT DURATION

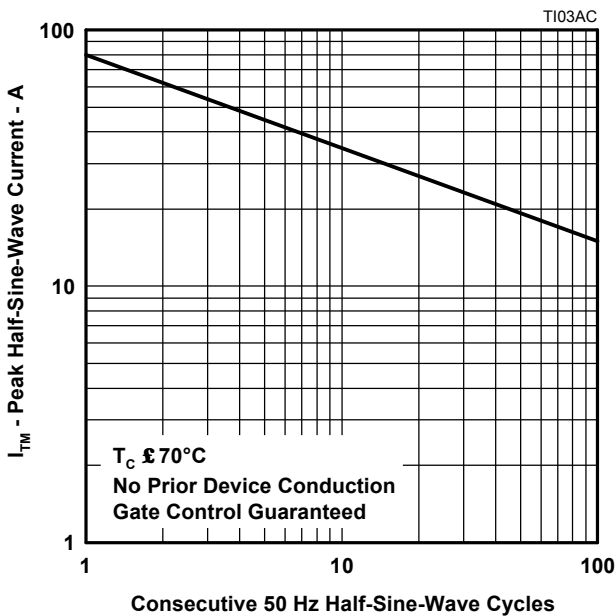

Figure 3.

TRANSIENT THERMAL RESISTANCE
VS
CYCLES OF CURRENT DURATION

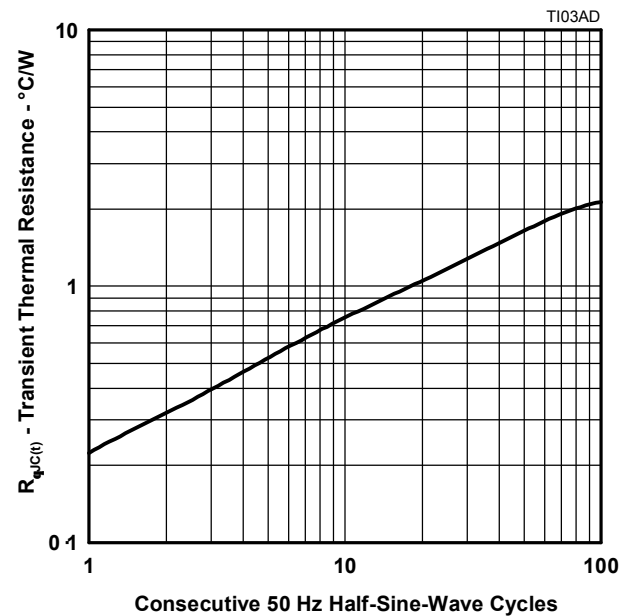

Figure 4.

TIC116 SERIES SILICON CONTROLLED RECTIFIERS

APRIL 1971 - REVISED JUNE 2000

TYPICAL CHARACTERISTICS

**GATE TRIGGER CURRENT
vs
CASE TEMPERATURE**

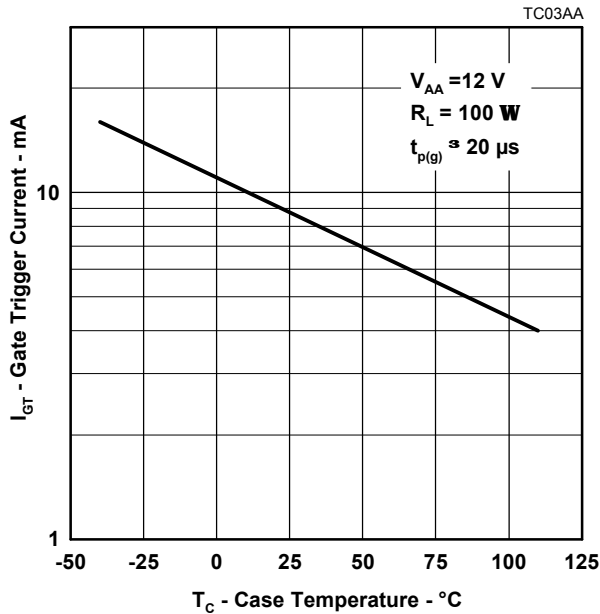

Figure 5.

**GATE TRIGGER VOLTAGE
vs
CASE TEMPERATURE**

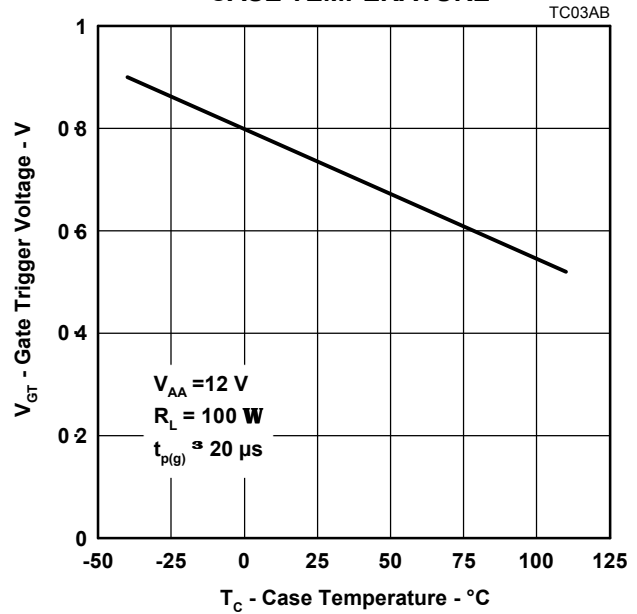

Figure 6.

**HOLDING CURRENT
vs
CASE TEMPERATURE**

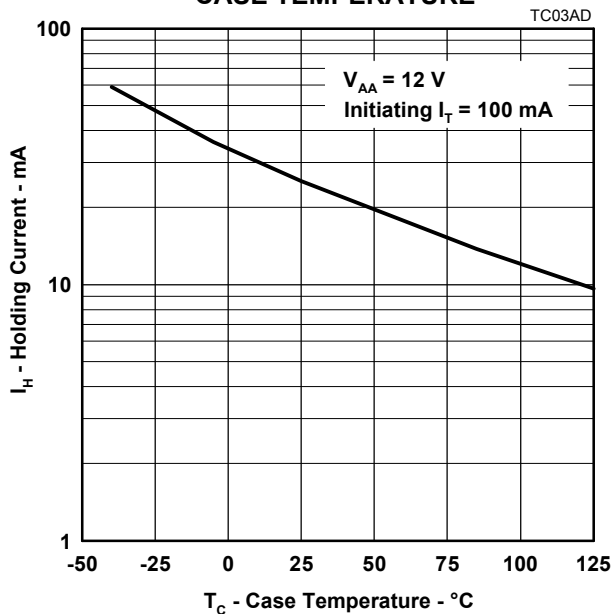

Figure 7.

**PEAK ON-STATE VOLTAGE
vs
PEAK ON-STATE CURRENT**

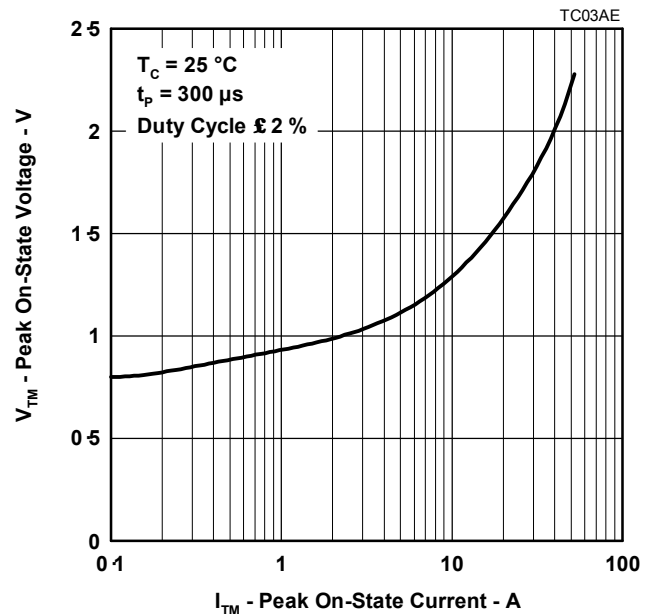

Figure 8.

PRODUCT INFORMATION

MECHANICAL DATA

TO-220

3-pin plastic flange-mount package

This single-in-line package consists of a circuit mounted on a lead frame and encapsulated within a plastic compound. The compound will withstand soldering temperature with no deformation, and circuit performance characteristics will remain stable when operated in high humidity conditions. Leads require no additional cleaning or processing when used in soldered assembly.

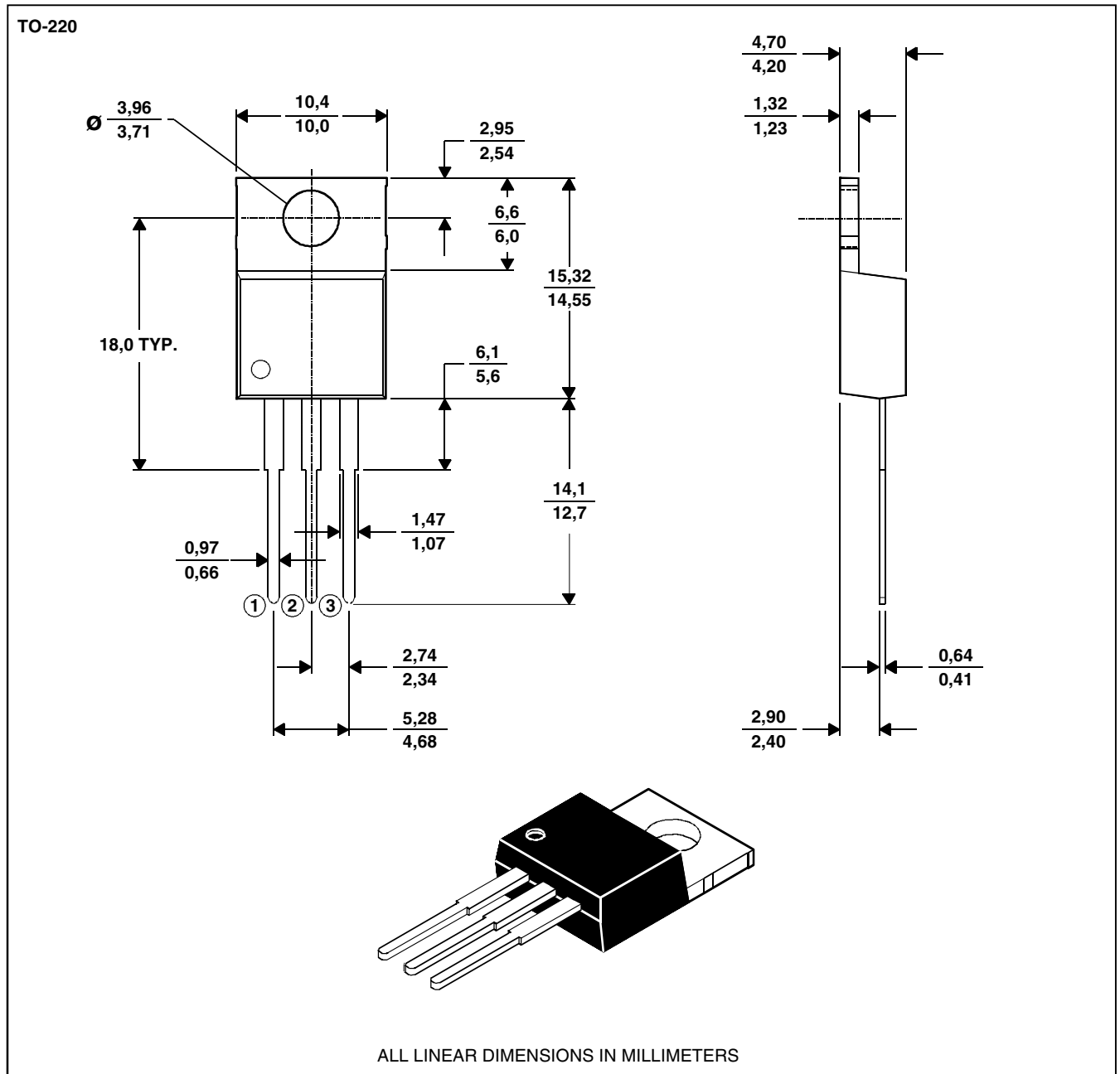

NOTE A: The centre pin is in electrical contact with the mounting tab.

TIC116 SERIES SILICON CONTROLLED RECTIFIERS

APRIL 1971 - REVISED JUNE 2000

IMPORTANT NOTICE

Power Innovations Limited (PI) reserves the right to make changes to its products or to discontinue any semiconductor product or service without notice, and advises its customers to verify, before placing orders, that the information being relied on is current.

PI warrants performance of its semiconductor products to the specifications applicable at the time of sale in accordance with PI's standard warranty. Testing and other quality control techniques are utilized to the extent PI deems necessary to support this warranty. Specific testing of all parameters of each device is not necessarily performed, except as mandated by government requirements.

PI accepts no liability for applications assistance, customer product design, software performance, or infringement of patents or services described herein. Nor is any license, either express or implied, granted under any patent right, copyright, design right, or other intellectual property right of PI covering or relating to any combination, machine, or process in which such semiconductor products or services might be or are used.

PI SEMICONDUCTOR PRODUCTS ARE NOT DESIGNED, INTENDED, AUTHORIZED, OR WARRANTED TO BE SUITABLE FOR USE IN LIFE-SUPPORT APPLICATIONS, DEVICES OR SYSTEMS.

Copyright © 2000, Power Innovations Limited

PRODUCT INFORMATION