

355-896/902

2SJ118, 2SJ119

SILICON P-CHANNEL MOS FET

**HIGH SPEED POWER SWITCHING,
HIGH FREQUENCY POWER AMPLIFIER**
Complementary pair with 2SK413, 2SK414

FEATURES

- Low On-Resistance
- High Speed Switching
- High Cutoff Frequency
- No Secondary Breakdown
- Suitable for Switching Regulator, DC-DC Converter, PWM Amplifiers, and Ultrasonic Power Oscillators

ABSOLUTE MAXIMUM RATINGS ($T_o=25^\circ\text{C}$)

Item	Symbol	2SJ118	2SJ119	Unit
Drain-Source Voltage	V_{DSS}	-140	-160	V
Gate-Source Voltage	V_{GSS}	± 20		V
Drain Current	I_D	-8		A
Drain Peak Current	$I_{D(peak)}$	-12		A
Body-Drain Diode Reverse Drain Current	I_{DR}	-8		A
Channel Dissipation	P_{ch}^*	100		W
Channel Temperature	T_{ch}	150		$^\circ\text{C}$
Storage Temperature	T_{stg}	-55 ~ +150		$^\circ\text{C}$

*Value at $T_c=25^\circ\text{C}$

ELECTRICAL CHARACTERISTICS ($T_o=25^\circ\text{C}$)

Item	Symbol	Test Condition	min	typ	max	Unit
Drain-Source Breakdown Voltage	$V_{(BR)DSS}$	$I_D = -10\text{mA}, V_{GS} = 0$	-140	-	-	V
			-160	-	-	V
Gate Source Leak Current	I_{GSS}	$V_{GS} = \pm 20\text{V}, V_{DS} = 0$	-	-	± 1	μA
Zero Gate Voltage Drain Current	I_{DSS}	$V_{DS} = -120\text{V}, V_{GS} = 0$ $V_{DS} = -140\text{V}, V_{GS} = 0$	-	-	-1	mA
			-	-	-	mA
Gate-Source Cutoff Voltage	$V_{GS(off)}$	$I_D = -1\text{mA}, V_{DS} = -10\text{V}$	-2.0	-	-5.0	V
Static Drain-Source On State Resistance	$R_{DS(on)}$	$I_D = -4\text{A}, V_{GS} = -15\text{V}^*$	-	0.4	0.5	Ω
Drain-Source Saturation Voltage	$V_{DS(on)}$	$I_D = -4\text{A}, V_{GS} = -15\text{V}^*$	-	-1.6	-2.0	V
Forward Transfer Admittance	$ y_{fs} $	$I_D = -4\text{A}, V_{DS} = -10\text{V}^*$	1.0	1.8	-	S
Input Capacitance	C_{iss}	$V_{DS} = -10\text{V}, V_{GS} = 0,$ $f = 1\text{MHz}$	-	1050	-	pF
Output Capacitance	C_{oss}		-	450	-	pF
Reverse Transfer Capacitance	C_{ris}		-	80	-	pF
Turn-on Delay Time	t_{don}	$I_D = -2\text{A}, V_{GS} = -15\text{V}$ $R_t = 15\Omega$	-	20	-	ns
Rise Time	t_r		-	50	-	ns
Turn-off Delay Time	t_{doff}		-	90	-	ns
Fall Time	t_f	-	70	-	ns	
Body Drain Diode Forward Voltage	V_{DF}	$I_F = 4\text{A}, V_{GS} = 0$	-	-0.9	-	V
Body Drain Diode Reverse Recovery Time	t_{rr}	$I_F = 4\text{A}, V_{GS} = 0$ $dI_F/dt = 50\text{A}/\mu\text{s}$	-	300	-	ns

*Pulse Test

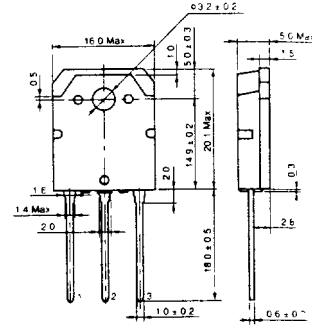
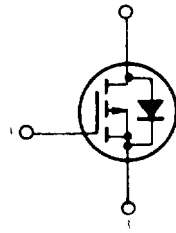

1 Gate
2 Drain (Flange)
3 Source
(TO-3P)
(Dimensions in mm)

POWER VS TEMPERATURE DERATING

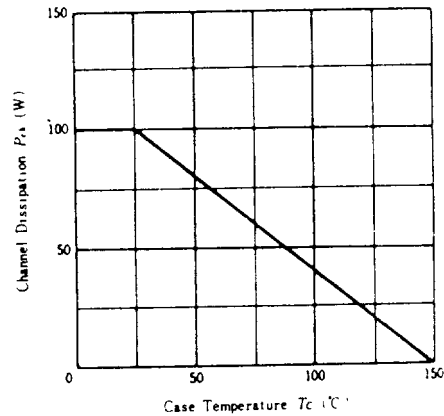

MAXIMUM SAFE OPERATION AREA

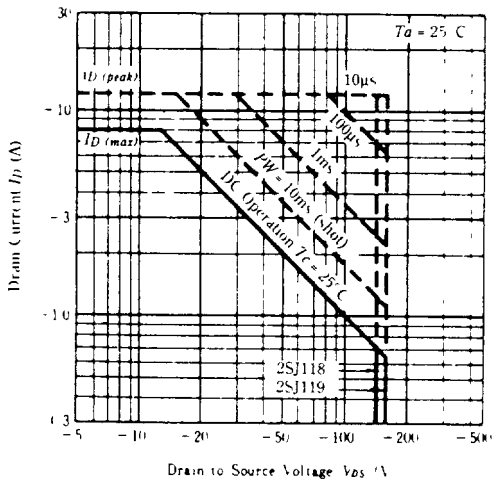

TYPICAL OUTPUT CHARACTERISTICS

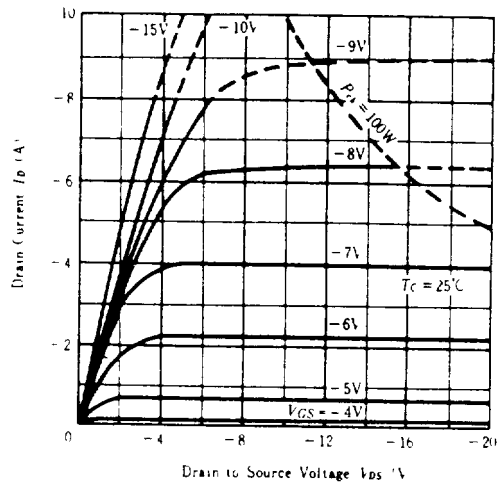

TYPICAL TRANSFER CHARACTERISTICS

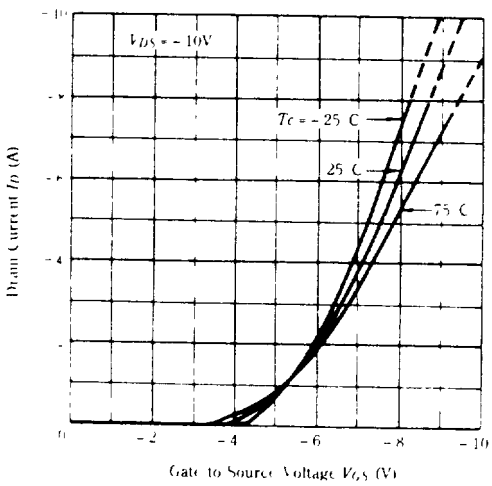

DRAIN - SOURCE SATURATION VOLTAGE VS GATE-SOURCE VOLTAGE

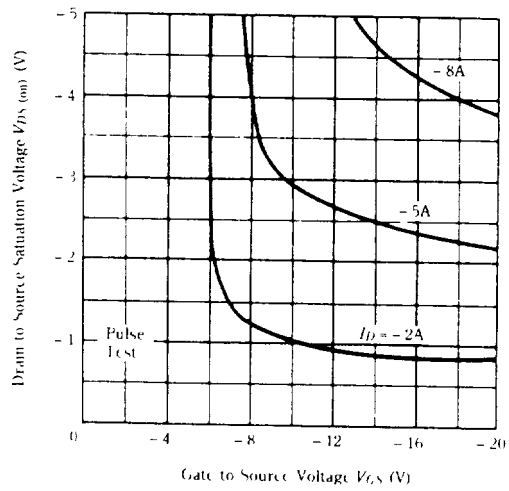

FORWARD TRANSFER ADMITTANCE VS DRAIN CURRENT

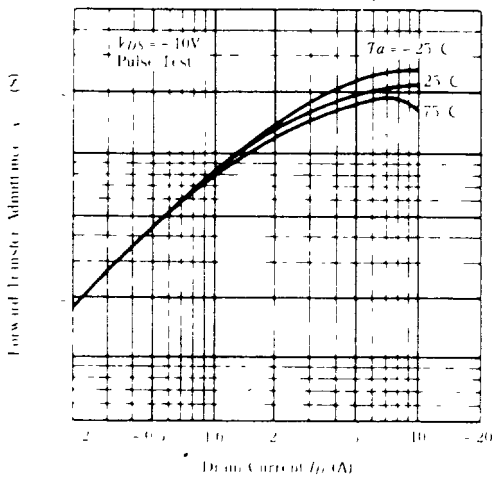

STATIC DRAIN-SOURCE ON STATE RESISTANCE VS TEMPERATURE

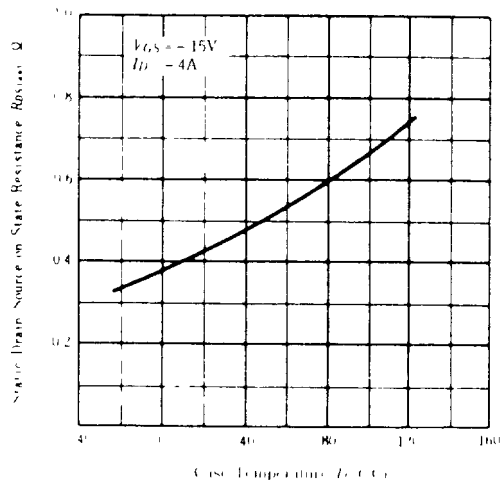

TYPICAL CAPACITANCE VS DRAIN-SOURCE VOLTAGE

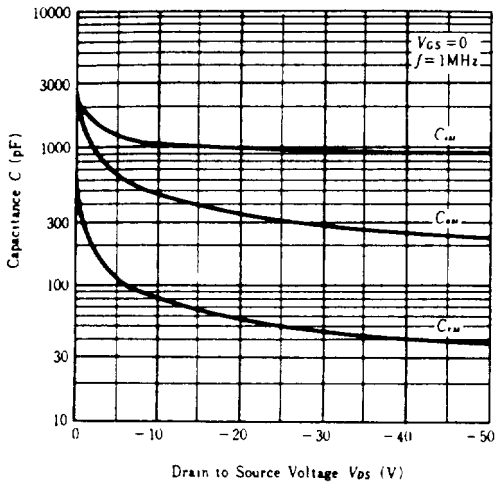

FORWARD TRANSFER ADMITTANCE VS FREQUENCY

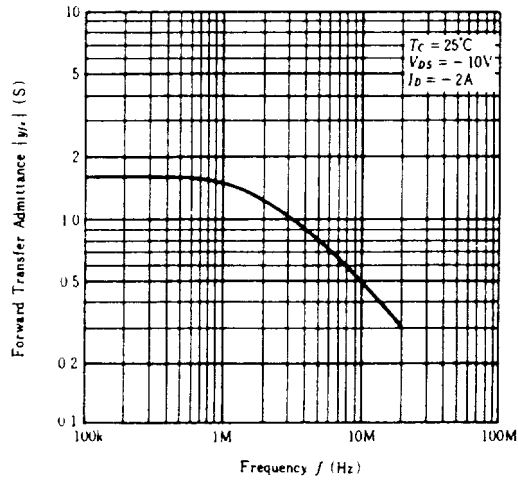

SWITCHING CHARACTERISTICS

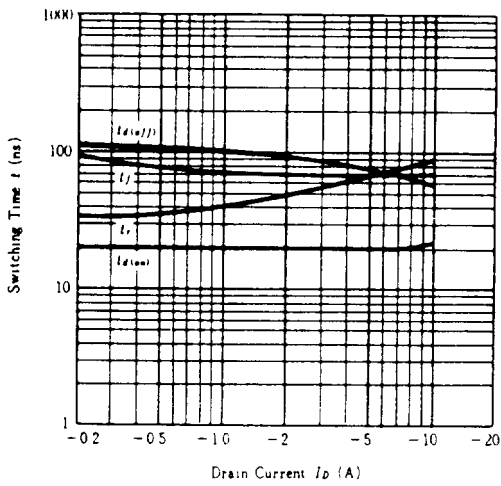

MAXIMUM BODY-DRAIN DIODE FORWARD VOLTAGE

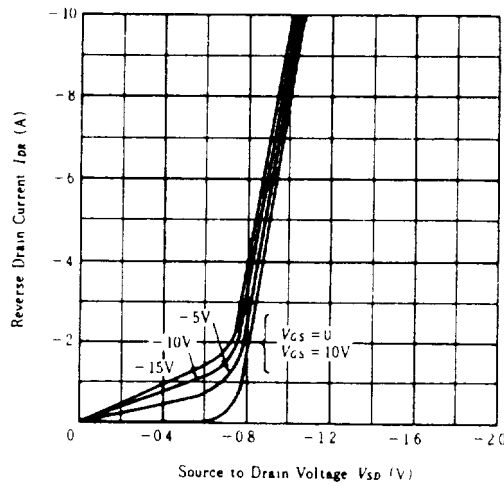

DYNAMIC INPUT CHARACTERISTICS

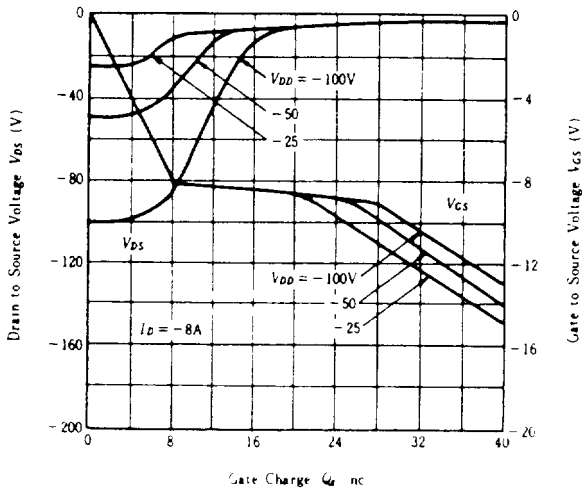

SWITCHING TIME TEST CIRCUIT

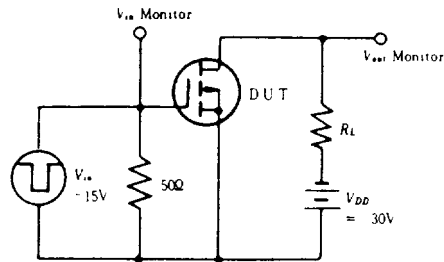

WAVEFORMS

