

## NPN Silicon AF and Switching Transistor

**BCX 41**  
**BSS 64**

- High breakdown voltage
- Low collector-emitter saturation voltage
- Complementary types: BCX 42, BSS 63 (PNP)

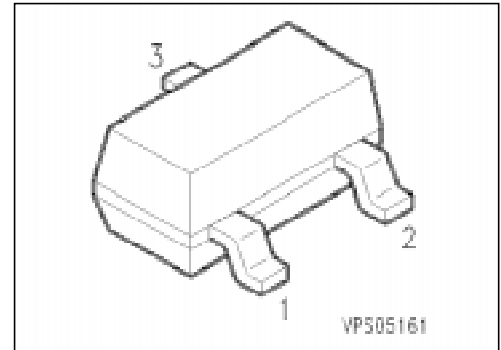

Type	Marking	Ordering Code (tape and reel)	Pin Configuration			Package <sup>1)</sup>
			1	2	3	
BCX 41 BSS 64	EKs AMs	Q62702-C1659 Q62702-S535	B	E	C	SOT-23

### Maximum Ratings

Parameter	Symbol	Values		Unit
		BSS 64	BCX 41	
Collector-emitter voltage	$V_{CE0}$	80	125	V
Collector-base voltage	$V_{CB0}$	120	125	
Emitter-base voltage	$V_{EB0}$	5	5	
Collector current	$I_C$	800		mA
Peak collector current	$I_{CM}$	1		A
Base current	$I_B$	100		mA
Peak base current	$I_{BM}$	200		
Total power dissipation, $T_s = 79\text{ °C}$	$P_{tot}$	330		mW
Junction temperature	$T_j$	150		°C
Storage temperature range	$T_{stg}$	- 65 ... + 150		

### Thermal Resistance

Junction - ambient <sup>2)</sup>	$R_{th\ JA}$	≤ 285	K/W
Junction - soldering point	$R_{th\ JS}$	≤ 215	

<sup>1)</sup> For detailed information see chapter Package Outlines.

<sup>2)</sup> Package mounted on epoxy pcb 40 mm × 40 mm × 1.5 mm/6 cm<sup>2</sup> Cu.

**Electrical Characteristics** at  $T_A = 25\text{ °C}$ , unless otherwise specified.

Parameter	Symbol	Values			Unit	
		min.	typ.	max.		
<b>DC characteristics</b>						
Collector-emitter breakdown voltage $I_C = 10\text{ mA}$	BSS 64 BCX 41	$V_{(BR)CE0}$	80 125	– –	– –	V
Collector-base breakdown voltage <sup>1)</sup> $I_C = 100\text{ }\mu\text{A}$	BSS 64 BCX 41	$V_{(BR)CB0}$	120 125	– –	– –	
Emitter-base breakdown voltage $I_E = 10\text{ }\mu\text{A}$		$V_{(BR)EB0}$	5	–	–	
Collector cutoff current $V_{CB} = 80\text{ V}$ $V_{CB} = 100\text{ V}$ $V_{CB} = 80\text{ V}, T_A = 150\text{ °C}$ $V_{CB} = 100\text{ V}, T_A = 150\text{ °C}$	BSS 64 BCX 41 BSS 64 BCX 41	$I_{CB0}$	– – – –	– – – –	100 100 20 20	nA nA $\mu\text{A}$ $\mu\text{A}$
Collector cutoff current $V_{CE} = 100\text{ V}$ $T_A = 85\text{ °C}$ $T_A = 125\text{ °C}$	BCX 41 BCX 41	$I_{CE0}$	– –	– –	10 75	$\mu\text{A}$
Emitter cutoff current $V_{EB} = 4\text{ V}$		$I_{EB0}$	–	–	100	nA
DC current gain <sup>1)</sup> $I_C = 100\text{ }\mu\text{A}, V_{CE} = 1\text{ V}$ $I_C = 1\text{ mA}, V_{CE} = 1\text{ V}$ $I_C = 4\text{ mA}, V_{CE} = 1\text{ V}$ $I_C = 10\text{ mA}, V_{CE} = 1\text{ V}$ $I_C = 20\text{ mA}, V_{CE} = 1\text{ V}$ $I_C = 100\text{ mA}, V_{CE} = 1\text{ V}$ $I_C = 200\text{ mA}, V_{CE} = 1\text{ V}$	BCX 41 BSS 64 BSS 64 BSS 64 BSS 64 BCX 41 BCX 41	$h_{FE}$	25 – 20 – – 63 40	– 60 80 80 55 – –	– – – – – – –	–
Collector-emitter saturation voltage <sup>1)</sup> $I_C = 300\text{ mA}, I_B = 30\text{ mA}$ $I_C = 4\text{ mA}, I_B = 0.4\text{ mA}$ $I_C = 50\text{ mA}, I_B = 15\text{ mA}$	BCX 41 BSS 64 BSS 64	$V_{CEsat}$	– – –	– – –	0.9 0.7 3.0	V
Base-emitter saturation voltage <sup>1)</sup> $I_C = 300\text{ mA}, I_B = 30\text{ mA}$	BCX 41	$V_{BEsat}$	–	–	1.4	
<b>AC characteristics</b>						
Transition frequency $I_C = 20\text{ mA}, V_{CE} = 5\text{ V}, f = 20\text{ MHz}$		$f_T$	–	100	–	MHz
Output capacitance $V_{CB} = 10\text{ V}, f = 1\text{ MHz}$		$C_{obo}$	–	12	–	pF

1) Pulse test:  $t \leq 300\text{ }\mu\text{s}, D = 2\%$

### Total power dissipation $P_{tot} = f(T_A^*; T_S)$

\* Package mounted on epoxy

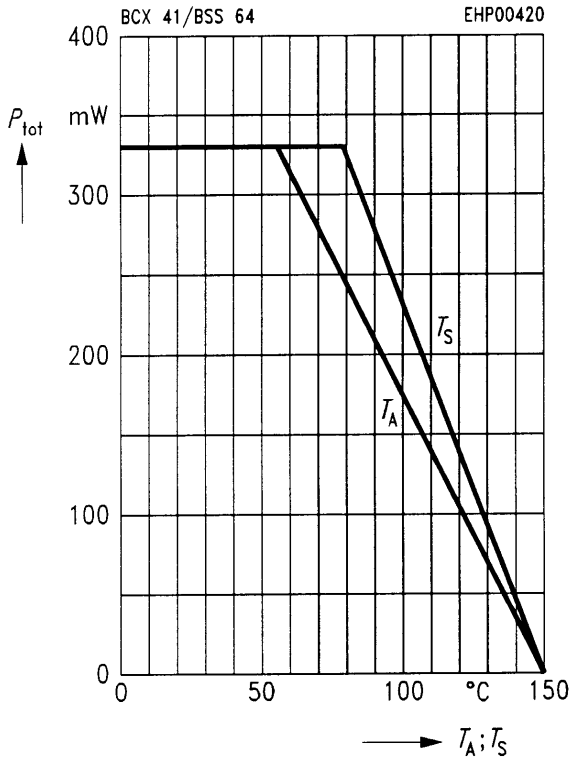

### Collector current $I_C = f(V_{BE})$

$V_{CE} = 1\text{ V}$

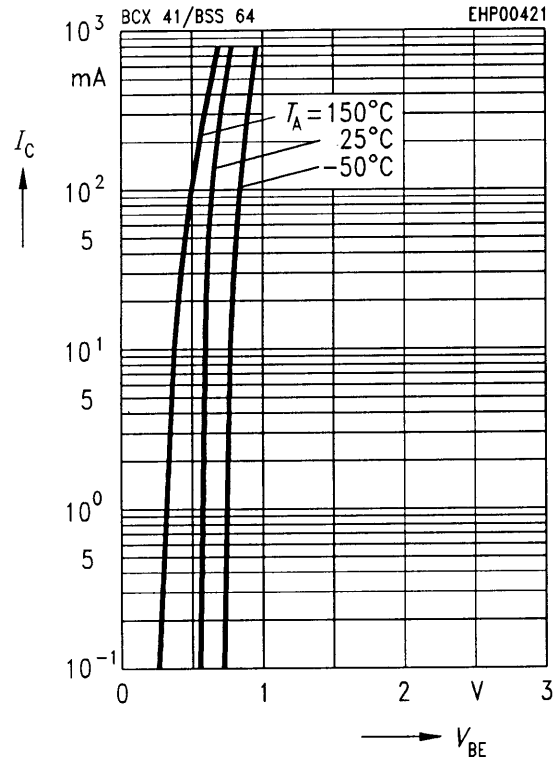

### Permissible pulse load $P_{tot\ max}/P_{tot\ DC} = f(t_p)$

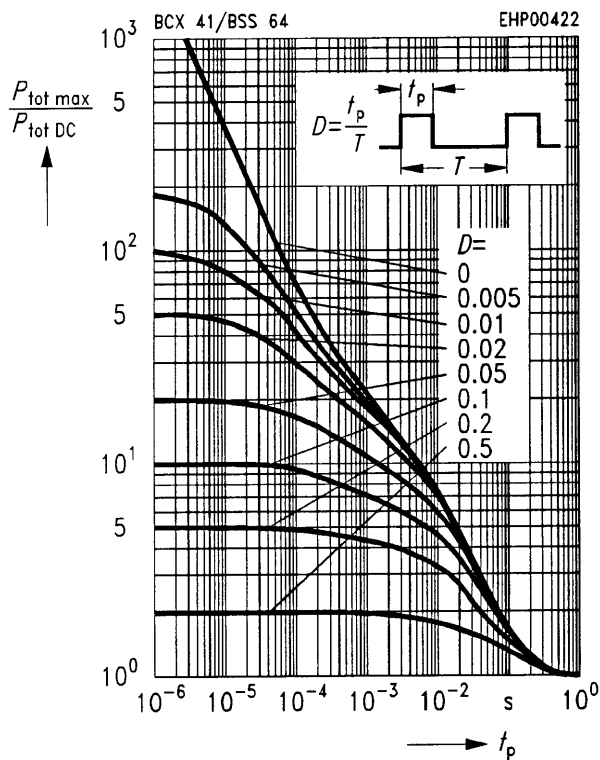

### Transition frequency $f_T = f(I_C)$

$V_{CE} = 5\text{ V}$

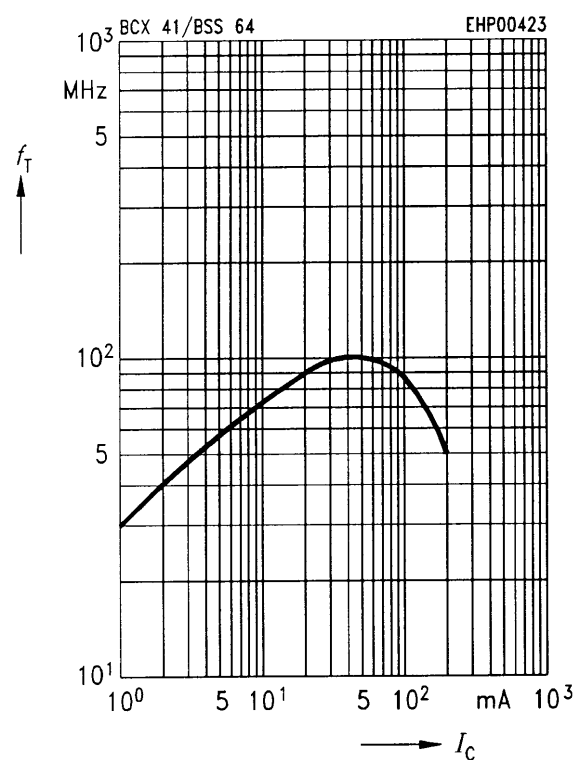

**Base-emitter saturation voltage**

$I_C = f(V_{BEsat})$

$h_{FE} = 10$

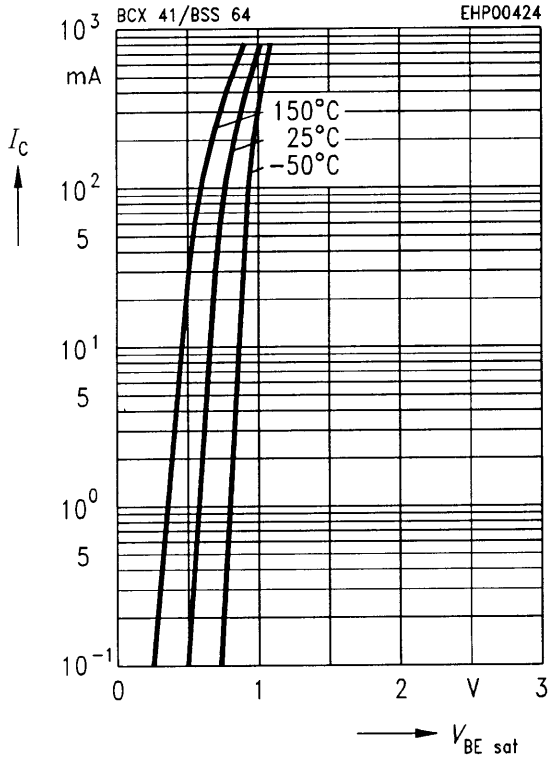

**Collector-emitter saturation voltage**

$I_C = f(V_{CEsat})$

$h_{FE} = 10$

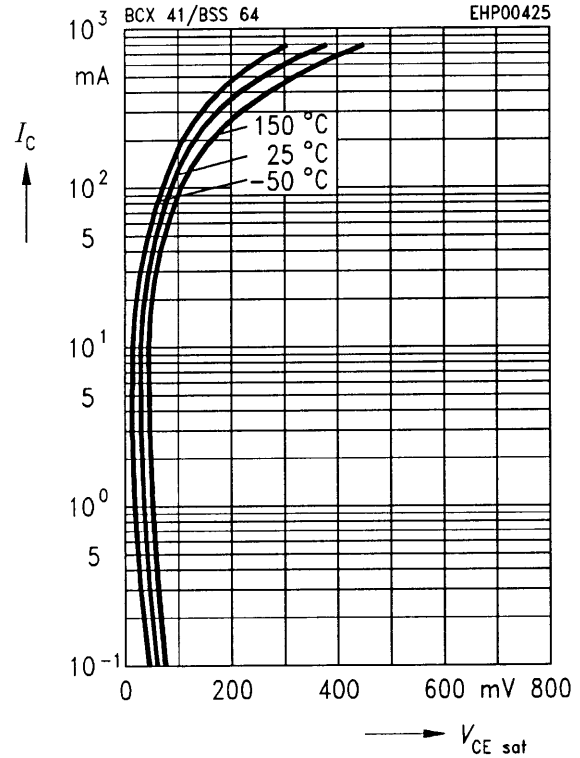

**Collector cutoff current  $I_{CB0} = f(T_A)$**

$V_{CB} = V_{CE max}$

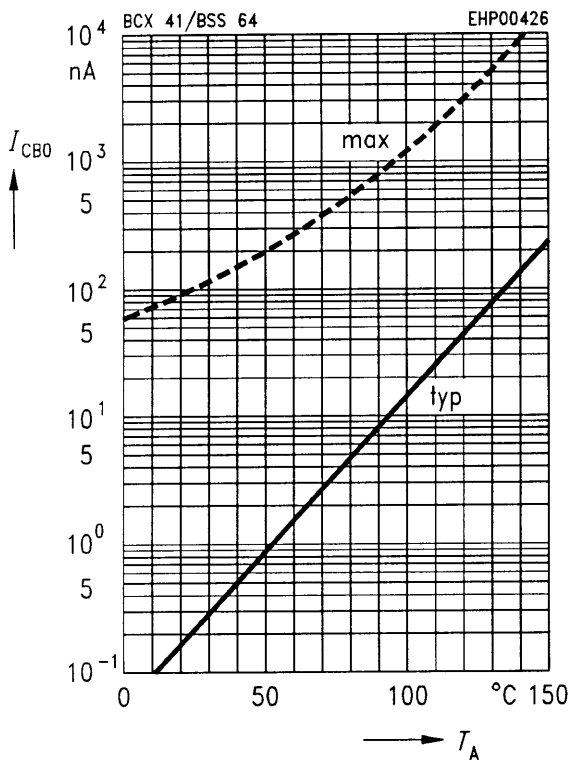

**DC current gain  $h_{FE} = f(I_C)$**

$V_{CE} = 1 V$

