

BD242, BD242A, BD242B, BD242C

1271

FOR POWER-AMPLIFIER AND HIGH-SPEED-SWITCHING APPLICATIONS
DESIGNED FOR COMPLEMENTARY USE WITH BD241A-C

- 40 W at 25 °C Case Temperature
- 3 A Rated Collector Current
- Min f_T of 3 MHz at 10 V, 500 mA

mechanical data

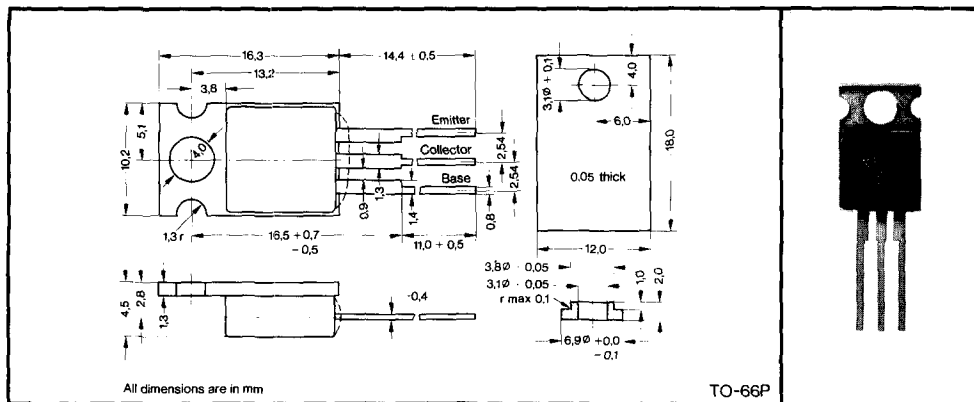

absolute maximum ratings at 25 °C case temperature (unless otherwise noted)

	BD242	BD242A	BD242B	BD242C
Collector-Emitter Voltage ($R_{BE} = 100 \Omega$)	-55 V	-70 V	-90 V	-115 V
Collector-Emitter Voltage (See Note 1)	-45 V	-80 V	-80 V	-100 V
Emitter-Base Voltage	←	-5 V	→	→
Continuous Collector Current	←	-3 A	→	→
Peak Collector Current (See Note 2)	←	-5 A	→	→
Continuous Base Current	←	-1 A	→	→
Safe Operating Region at (or below) 25 °C Case Temperature	←	See Figure 5	→	→
Continuous Device Dissipation at (or below) 25 °C Case Temperature (See Note 3)	←	40 W	→	→
Continuous Device Dissipation at (or below) 25 °C Free-Air Temperature (See Note 4)	←	2 W	→	→
Unclamped Inductive Load Energy (See Note 5)	←	32 mJ	→	→
Operating Collector Junction Temperature Range	←	-65 °C to 150 °C	→	→
Storage Temperature Range	←	-65 °C to 150 °C	→	→
Lead Temperature 1/8 Inch from Case for 5 Seconds	←	250 °C	→	→

- NOTES: 1. This value applies when the base-emitter diode is open-circuited.
 2. This value applies for $t_w \leq 0.3$ ms, duty cycle $\leq 10\%$.
 3. Derate linearly to 150 °C case temperature at the rate of 0.32 W/°C.
 4. Derate linearly to 150 °C free-air temperature at the end of 16 mW/°C.
 5. This rating is based on the capability of the transistor to operate safely in the circuit of Figure 2. $L = 20$ mH, $R_{BB1} = 100 \Omega$, $V_{BB2} = 0$ V, $R_S = 0.1 \Omega$, $V_{CC} = 10$ V. Energy $\approx I_C^2 L/2$.

PRELIMINARY DATA SHEET:
Supplementary data may be
published at a later date.

TEXAS INSTRUMENTS

2-35

BD242, BD242A, BD242B, BD242C

electrical characteristics at 25 °C case temperature

PARAMETER	TEST CONDITIONS	BD242		BD242A		BD242B		BD242C		UNIT
		MIN	MAX	MIN	MAX	MIN	MAX	MIN	MAX	
$V_{(BR)CEO}$	$I_C = -30$ mA, See Note 6	$I_B = 0$,	-45		-60		-80		-100	V
I_{CEO}	$V_{CE} = -30$ V, $V_{CE} = -60$ V,	$I_B = 0$ $I_B = 0$	-0.3		-0.3		-0.3		-0.3	mA
I_{CES}	$V_{CE} = -45$ V, $V_{CE} = -60$ V, $V_{CE} = -80$ V, $V_{CE} = -100$ V,	$V_{BE} = 0$ $V_{BE} = 0$ $V_{BE} = 0$ $V_{BE} = 0$	-0.2		-0.2		-0.2		-0.2	mA
I_{EBO}	$V_{EB} = -5$ V,	$I_C = 0$	-1		-1		-1		-1	mA
h_{FE}	$V_{CE} = -4$ V, See Notes 6 and 7	$I_C = -1$ A,	25		25		25		25	
	$V_{CE} = -4$ V, See Notes 6 and 7	$I_C = -3$ A,	10		10		10		10	
V_{BE}	$V_{CE} = -4$ V, See Notes 6 and 7	$I_C = -3$ A,	-1.8		-1.8		-1.8		-1.8	V
$V_{CE(sat)}$	$I_B = -600$ mA, See Notes 6 and 7	$I_C = -3$ A,	-1.2		-1.2		-1.2		-1.2	V
h_{fe}	$V_{CE} = -10$ V, $f = 1$ kHz	$I_C = -0.5$ A,	20		20		20		20	
$ h_{fe} $	$V_{CE} = -10$ V, $f = 1$ MHz	$I_C = -0.5$ A,	3		3		3		3	

NOTES: 6. These parameters must be measured using pulse techniques. $t_W = 300$ μ s, duty cycle ≤ 2 %.

7. These parameters are measured with voltage-sensing contacts separate from the current-carrying contacts.

thermal characteristics

PARAMETER		MAX	UNIT
$R\theta_{JC}$	Junction-to-Case Thermal Resistance	3.125	°C/W
$R\theta_{JA}$	Junction-to-Free-Air Thermal Resistance	62.5	

switching characteristics at 25 °C case temperature

PARAMETER	TEST CONDITIONS ⁺			TYP	UNIT
t_{on}	$I_C = -1$ A,	$I_B(1) = -100$ mA,	$I_B(2) = 100$ mA,	0.2	μ s
t_{off}	$V_{BE(off)} = 3.7$ V,	$R_L = 20$ Ω ,	See Figure 1	0.3	

⁺ Voltage and current values shown are nominal; exact values vary slightly with transistor parameters.

BD242, BD242A, BD242B, BD242C

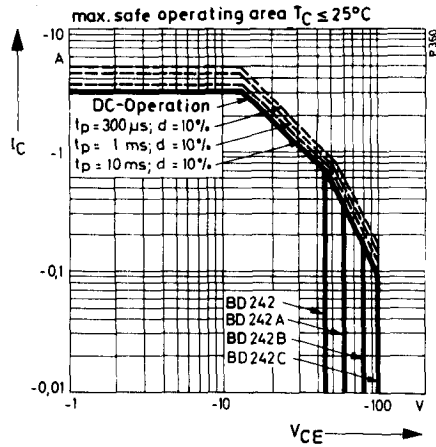
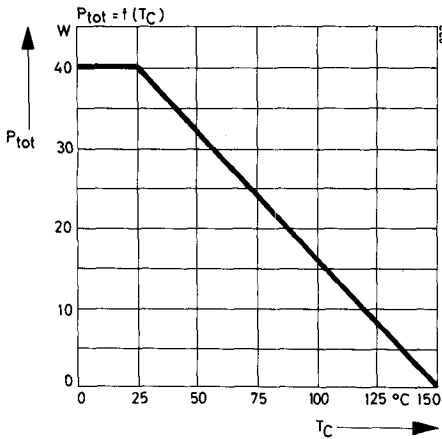
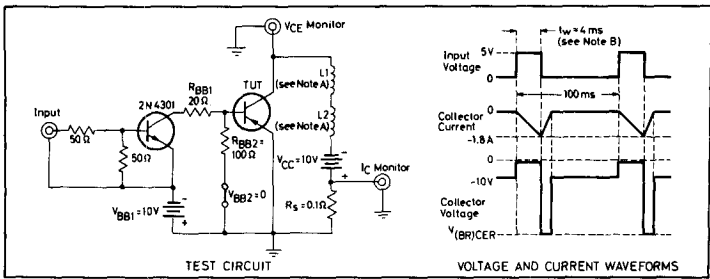
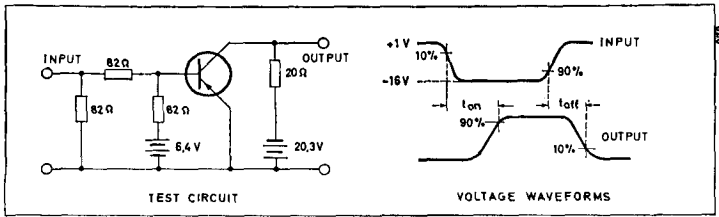

BD242, BD242A, BD242B, BD242C

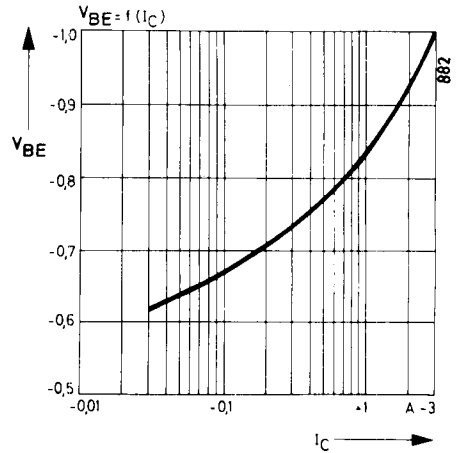
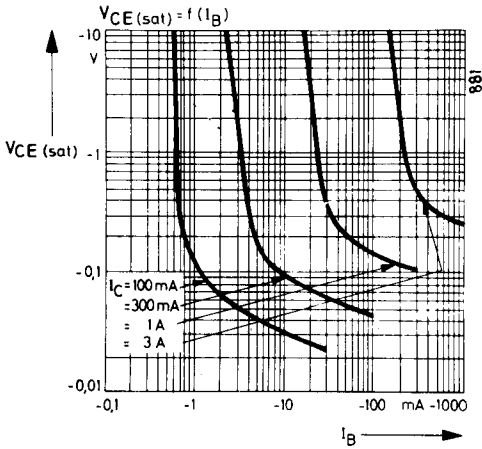
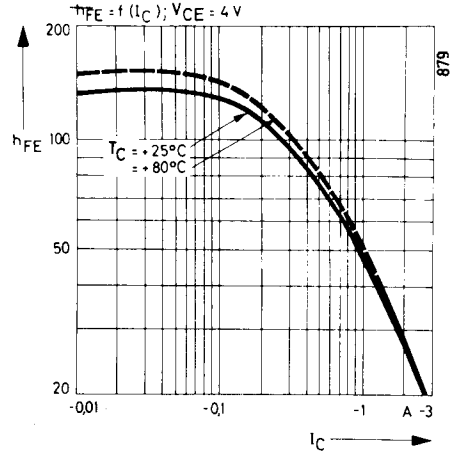
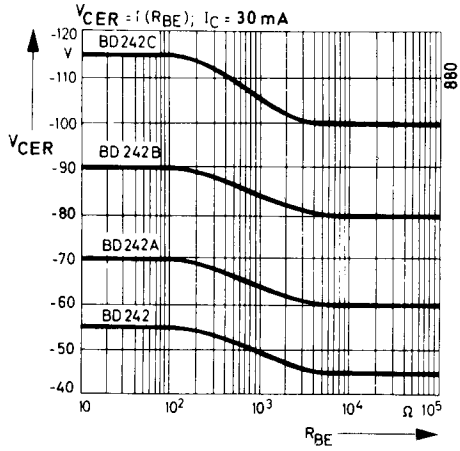

TEXAS INSTRUMENTS

**SILIZIUM-KOMPLEMENTARE-LEISTUNGSTRANSISTOREN
(Allgemeine und NF-Anwendungen)**

**SILICON COMPLEMENTARY POWER TRANSISTORS
(General and Low-frequency Applications)**

Type		$P_{tot}^{(a)}$	V_{CEO}	I_{CD}		h_{FE}	I_C
type		$T_C = 25\text{ }^\circ\text{C}$	min	max	min	max	A
NPN	PNP	(100 $^\circ\text{C}$)		A			
		W					
BD 239	BD 240	30	45	2	40		0,2
BD 239 A	BD 240 A	30	60	2	40		0,2
BD 239 B	BD 240 B	30	80	2	40		0,2
BD 239 C	BD 240 C	30	100	2	40		0,2
BD 241	BD 242	40	45	3	25		1
BD 241 A	BD 242 A	40	60	3	25		1
BD 241 B	BD 242 B	40	80	3	25		1
BD 241 C	BD 242 C	40	100	3	25		1
BD 243	BD 244	65	45	6	30		0,3
BD 243 A	BD 244 A	65	60	6	30		0,3
BD 243 B	BD 244 B	65	80	6	30		0,3
BD 243 C	BD 244 C	65	100	6	30		0,3
BD 245	BD 246	80	45	10	40		1
BD 245 A	BD 246 A	80	60	10	40		1
BD 245 B	BD 246 B	80	80	10	40		1
BD 245 C	BD 246 C	80	100	10	40		1
BD 249	BD 250	125	45	25	25		1,5
BD 249 A	BD 250 A	125	60	25	25		1,5
BD 249 B	BD 250 B	125	80	25	25		1,5
BD 249 C	BD 250 C	125	100	25	25		1,5
TIP 29	TIP 30	30	40	1	40	200	0,2
TIP 29 A	TIP 30 A	30	60	1	40	200	0,2
TIP 29 B	TIP 30 B	30	80	1	40	200	0,2
TIP 29 C	TIP 30 C	30	100	1	40	200	0,2
TIP 31	TIP 32	40	40	3	25	100	1
TIP 31 A	TIP 32 A	40	60	3	25	100	1
TIP 31 B	TIP 32 B	40	80	3	25	100	1
TIP 31 C	TIP 32 C	40	100	3	25	100	1
TIP 33	TIP 34	80	40	10	40	125	1
TIP 33 A	TIP 34 A	80	60	10	40	125	1
TIP 33 B	TIP 34 B	80	80	10	40	125	1
TIP 33 C	TIP 34 C	80	100	10	40	125	1
TIP 35	TIP 36	90	40	25	25	100	1,5
TIP 35 A	TIP 36 A	90	60	25	25	100	1,5

f_T m n M Hz	I_{CES} @ (I_{CEO}) μA	VCE V	Gehäuse package	Anwendungen, Bemerkungen applications, remarks
			TO-66P TO-66P TO-66P TO-66P	
			TO-66P TO-66P TO-66P TO-66P	
			TO-66P TO-66P TO-66P TO-66P	Verstärker, Schalter amplifier, switch
			TO-3P TO-3P TO-3P TO-3P	
			TO-3P TO-3P TO-3P TO-3P	
3	200	40	TO-66P	Verstärker, Schalter, komplementär zu TIP 30 amplifier, switch, complementary to TIP 30
3	200	60	TO-66P	Verstärker, Schalter, komplementär zu TIP 30 A amplifier, switch, complementary to TIP 30 A
3	200	80	TO-66P	Verstärker, Schalter, komplementär zu TIP 30 B amplifier, switch, complementary to TIP 30 B
3	200	100	TO-66P	Verstärker, Schalter, komplementär zu TIP 30 C amplifier, switch, complementary to TIP 30 C
3	300	40	TO-66P	Verstärker, Schalter, komplementär zu TIP 32 amplifier, switch, complementary to TIP 32
3	300	60	TO-3P	Verstärker, Schalter, komplementär zu TIP 32 A amplifier, switch, complementary to TIP 32 A
3	300	80	TO-3P	Verstärker, Schalter, komplementär zu TIP 32 B amplifier, switch, complementary to TIP 32 B
3	300	100	TO-3P	Verstärker, Schalter, komplementär zu TIP 32 C amplifier, switch, complementary to TIP 32 C
3	400	40	TO-3P	Verstärker, Schalter, komplementär zu TIP 34 amplifier, switch, complementary to TIP 34
3	400	60	TO-3P	Verstärker, Schalter, komplementär zu TIP 34 A amplifier, switch, complementary to TIP 34 A
3	400	80	TO-3P	Verstärker, Schalter, komplementär zu TIP 34 B amplifier, switch, complementary to TIP 34 B
3	400	100	TO-3P	Verstärker, Schalter, komplementär zu TIP 34 C amplifier, switch, complementary to TIP 34 C
3	700	40	TO-3P	Verstärker, Schalter, komplementär zu TIP 36 amplifier, switch, complementary to TIP 36
3	700	60	TO-3P	Verstärker, Schalter, komplementär zu TIP 36 A amplifier, switch, complementary to TIP 36 A

Typ type	f MHz	V _{CC}	P _{in}	P _{out}	BV _{CBO}	BV _{CEO}	Gehäuse package
2N 5713	150	13	3,4	11	60	40	TO-128
2N 5773	400	28	0,12	1,5	65	35	TO-117
2N 5774	400	26	1	8	65	35	TO-129
2N 5848	50	12,5	3,25	20	48	24	145

NF-TRANSISTOREN PNP/NPN NF TRANSISTORS PNP/NPN

Typ type		P _{tot} @ T _C = 25 °C (100 °C)	V _{CEO} min V	I _{CD} max A	min	hFE max	@ I _C A
PNP	NPN	W					
BD 136	BD 135	6,5	45	1	40	250	0,15
BD 138	BD 137	6,5	60	1	40	160	0,15
BD 140	BD 139	6,5	80	1	40	160	0,15
BD 240	BD 239	30	-45	-2	40		0,2
BD 240 A	BD 239 A	30	-60	-2	40		0,2
BD 240 B	BD 239 B	30	-80	-2	40		0,2
BD 240 C	BD 239 C	30	-100	-2	40		0,2
BD 242	BD 241	40	-45	-3	25		1
BD 242 A	BD 241 A	40	-60	-3	25		1
BD 242 B	BD 241 B	40	-80	-3	25		1
BD 242 C	BD 241 C	40	-100	-3	25		1
BD 244	BD 243	65	-45	-6	30		0,3
BD 244 A	BD 243 A	65	-60	-6	30		0,3
BD 244 B	BD 243 B	65	-80	-6	30		0,3
BD 244 C	BD 243 C	65	-100	-6	30		0,3
BD 246	BD 245	80	-45	-10	40		1
BD 246 A	BD 245 A	80	-60	-10	40		1
BD 246 B	BD 245 B	80	-80	-10	40		1
BD 246 C	BD 245 C	80	-100	-10	40		1
BD 250	BD 249	125	-45	-25	25		1,5
BD 250 A	BD 249 A	125	-60	-25	25		1,5
BD 250 B	BD 249 B	125	-80	-25	25		1,5
BD 250 C	BD 249 C	125	-100	-25	25		1,5
BDX 14		30	-60	-3	25	100	-0,5
BDX 15		117	-70	-10	20	70	-4

Typ type	f MHz	V _{CC}	P _{in}	P _{out}	BV _{CBO}	BV _{CEO}	Gehäuse package
2N 5941	30	28		40PEP	65	35	DIA-4L
2N 5942	30	28		80PEP	65	35	DIA-4L
2N 5943	250	15	50 mA	7 dB	40	30	TO-39

f _r MHz	I _{CS} (I _{CEO}) μA	@ V _{CE} V	Gehäuse package	Anwendungen, Bemerkungen applications, remarks
			SOT-32 SOT-32 SOT-32	P _{tot} = T _C 65 °C
			TO-66P TO-66P TO-66P TO-66P	
			TO-66P TO-66P TO-66P TO-66P	
			TO-66P TO-66P TO-66P TO-66P	Verstärker und Schalter amplifier and switch
			TO-3P TO-3P TO-3P TO-3P	
			TO-3P TO-3P TO-3P TO-3P	
0,8			TO-66	Schalter, Verstärker, komplementär 2N 3054
0,8			TO-3	Schalter, Verstärker, komplementär 2N 3055