

DATA SHEET

BF245A; BF245B; BF245C N-channel silicon field-effect transistors

Product specification
Supersedes data of April 1995
File under Discrete Semiconductors, SC07

1996 Jul 30

N-channel silicon field-effect transistors **BF245A; BF245B; BF245C**

FEATURES

- Interchangeability of drain and source connections
- Frequencies up to 700 MHz.

APPLICATIONS

- LF, HF and DC amplifiers.

DESCRIPTION

General purpose N-channel symmetrical junction field-effect transistors in a plastic TO-92 variant package.

CAUTION

The device is supplied in an antistatic package. The gate-source input must be protected against static discharge during transport or handling.

PINNING

PIN	SYMBOL	DESCRIPTION
1	d	drain
2	s	source
3	g	gate

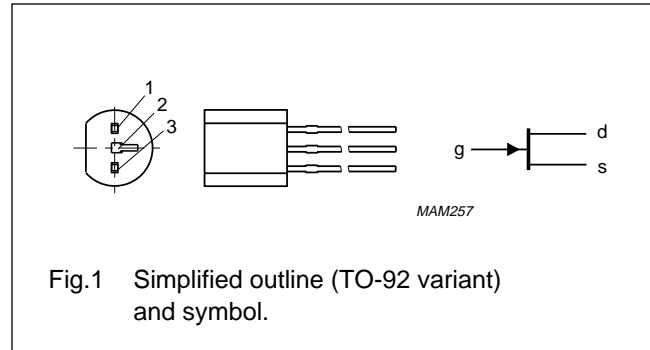

QUICK REFERENCE DATA

SYMBOL	PARAMETER	CONDITIONS	MIN.	TYP.	MAX.	UNIT
V_{DS}	drain-source voltage		–	–	± 30	V
V_{GSoff}	gate-source cut-off voltage	$I_D = 10 \text{ nA}; V_{DS} = 15 \text{ V}$	–0.25	–	–8	V
V_{GS0}	gate-source voltage	open drain	–	–	–30	V
I_{DSS}	drain current	$V_{DS} = 15 \text{ V}; V_{GS} = 0$				
	BF245A		2	–	6.5	mA
	BF245B		6	–	15	mA
	BF245C		12	–	25	mA
P_{tot}	total power dissipation	$T_{amb} = 75 \text{ }^\circ\text{C}$	–	–	300	mW
$ y_{fs} $	forward transfer admittance	$V_{DS} = 15 \text{ V}; V_{GS} = 0;$ $f = 1 \text{ kHz}; T_{amb} = 25 \text{ }^\circ\text{C}$	3	–	6.5	mS
C_{rs}	reverse transfer capacitance	$V_{DS} = 20 \text{ V}; V_{GS} = -1 \text{ V};$ $f = 1 \text{ MHz}; T_{amb} = 25 \text{ }^\circ\text{C}$	–	1.1	–	pF

N-channel silicon field-effect transistors

BF245A; BF245B; BF245C

LIMITING VALUES

In accordance with the Absolute Maximum Rating System (IEC 134).

SYMBOL	PARAMETER	CONDITIONS	MIN.	MAX.	UNIT
V_{DS}	drain-source voltage		–	± 30	V
V_{GDO}	gate-drain voltage	open source	–	–30	V
V_{GSO}	gate-source voltage	open drain	–	–30	V
I_D	drain current		–	25	mA
I_G	gate current		–	10	mA
P_{tot}	total power dissipation	up to $T_{amb} = 75\text{ °C}$;	–	300	mW
		up to $T_{amb} = 90\text{ °C}$; note 1	–	300	mW
T_{stg}	storage temperature		–65	+150	°C
T_j	operating junction temperature		–	150	°C

Note

- Device mounted on a printed-circuit board, minimum lead length 3 mm, mounting pad for drain lead minimum 10 mm × 10 mm.

THERMAL CHARACTERISTICS

SYMBOL	PARAMETER	CONDITIONS	VALUE	UNIT
$R_{th\ j-a}$	thermal resistance from junction to ambient	in free air	250	K/W
	thermal resistance from junction to ambient		200	K/W

STATIC CHARACTERISTICS

$T_j = 25\text{ °C}$; unless otherwise specified.

SYMBOL	PARAMETER	CONDITIONS	MIN.	MAX.	UNIT
$V_{(BR)GSS}$	gate-source breakdown voltage	$I_G = -1\ \mu\text{A}$; $V_{DS} = 0$	–30	–	V
V_{GSoff}	gate-source cut-off voltage	$I_D = 10\ \text{nA}$; $V_{DS} = 15\ \text{V}$	–0.25	–8.0	V
V_{GS}	gate-source voltage	$I_D = 200\ \mu\text{A}$; $V_{DS} = 15\ \text{V}$			
	BF245A		–0.4	–2.2	V
	BF245B		–1.6	–3.8	V
	BF245C	–3.2	–7.5	V	
I_{DSS}	drain current	$V_{DS} = 15\ \text{V}$; $V_{GS} = 0$; note 1			
	BF245A		2	6.5	mA
	BF245B		6	15	mA
	BF245C	12	25	mA	
I_{GSS}	gate cut-off current	$V_{GS} = -20\ \text{V}$; $V_{DS} = 0$	–	–5	nA
		$V_{GS} = -20\ \text{V}$; $V_{DS} = 0$; $T_j = 125\text{ °C}$	–	–0.5	μA

Note

- Measured under pulse conditions: $t_p = 300\ \mu\text{s}$; $\delta \leq 0.02$.

N-channel silicon field-effect transistors

BF245A; BF245B; BF245C

DYNAMIC CHARACTERISTICS

Common source; $T_{amb} = 25\text{ }^{\circ}\text{C}$; unless otherwise specified.

SYMBOL	PARAMETER	CONDITIONS	MIN.	TYP.	MAX.	UNIT
C_{is}	input capacitance	$V_{DS} = 20\text{ V}; V_{GS} = -1\text{ V}; f = 1\text{ MHz}$	–	4	–	pF
C_{rs}	reverse transfer capacitance	$V_{DS} = 20\text{ V}; V_{GS} = -1\text{ V}; f = 1\text{ MHz}$	–	1.1	–	pF
C_{os}	output capacitance	$V_{DS} = 20\text{ V}; V_{GS} = -1\text{ V}; f = 1\text{ MHz}$	–	1.6	–	pF
g_{is}	input conductance	$V_{DS} = 15\text{ V}; V_{GS} = 0; f = 200\text{ MHz}$	–	250	–	μS
g_{os}	output conductance	$V_{DS} = 15\text{ V}; V_{GS} = 0; f = 200\text{ MHz}$	–	40	–	μS
$ y_{fs} $	forward transfer admittance	$V_{DS} = 15\text{ V}; V_{GS} = 0; f = 1\text{ kHz}$	3	–	6.5	mS
		$V_{DS} = 15\text{ V}; V_{GS} = 0; f = 200\text{ MHz}$	–	6	–	mS
$ y_{rs} $	reverse transfer admittance	$V_{DS} = 15\text{ V}; V_{GS} = 0; f = 200\text{ MHz}$	–	1.4	–	mS
$ y_{os} $	output admittance	$V_{DS} = 15\text{ V}; V_{GS} = 0; f = 1\text{ kHz}$	–	25	–	μS
f_{gfs}	cut-off frequency	$V_{DS} = 15\text{ V}; V_{GS} = 0; g_{fs} = 0.7$ of its value at 1 kHz	–	700	–	MHz
F	noise figure	$V_{DS} = 15\text{ V}; V_{GS} = 0; f = 100\text{ MHz}; R_G = 1\text{ k}\Omega$ (common source); input tuned to minimum noise	–	1.5	–	dB

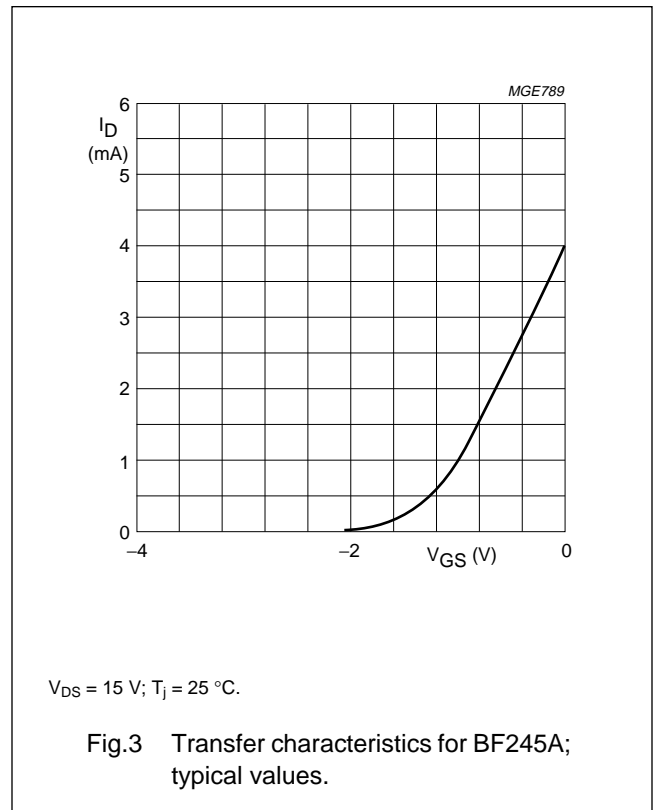
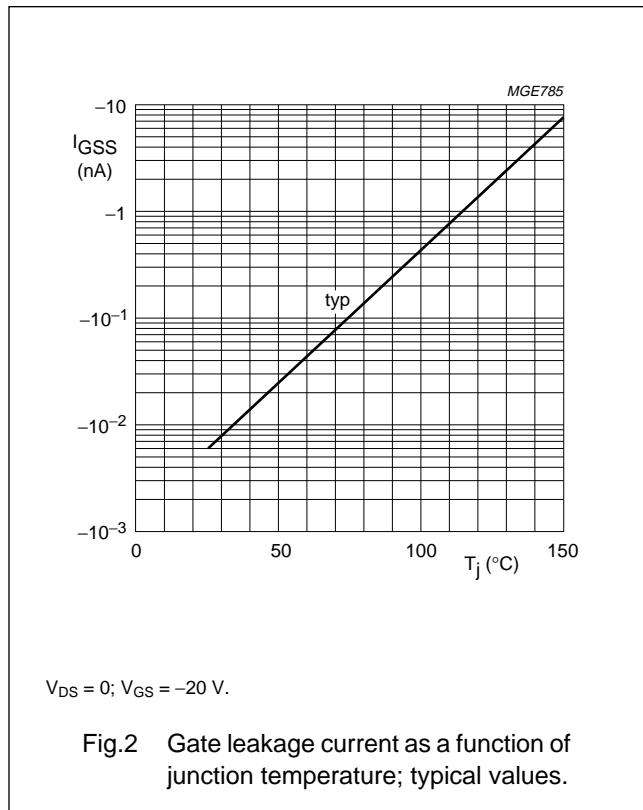

N-channel silicon field-effect transistors

BF245A; BF245B; BF245C

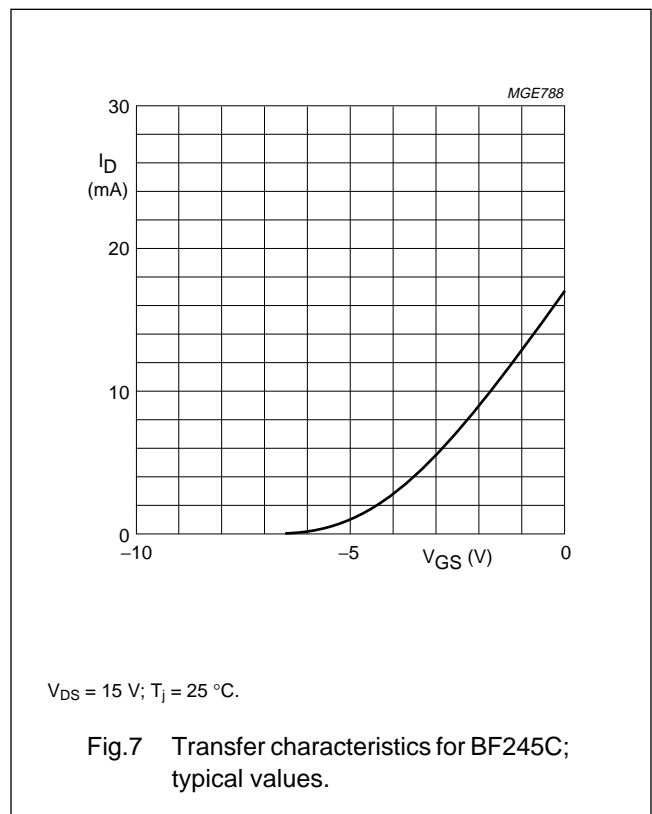
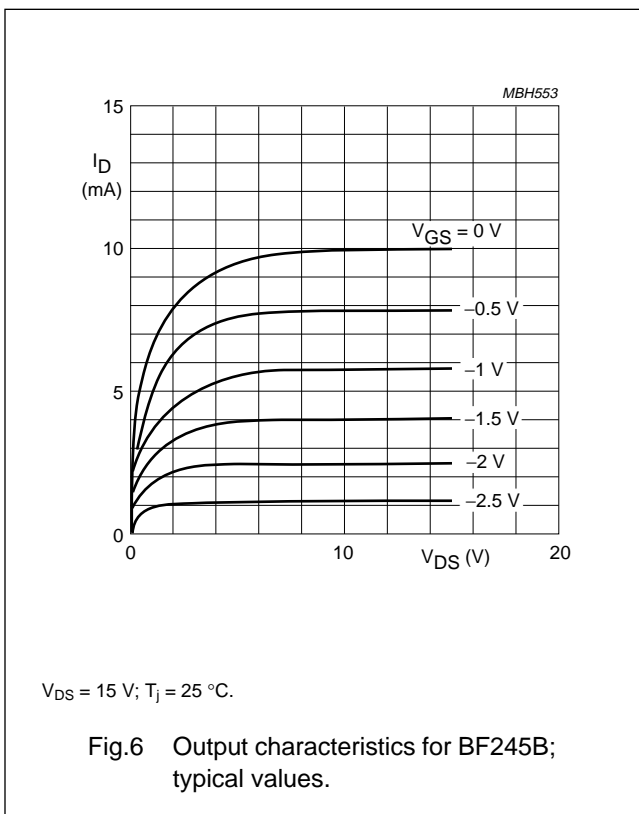
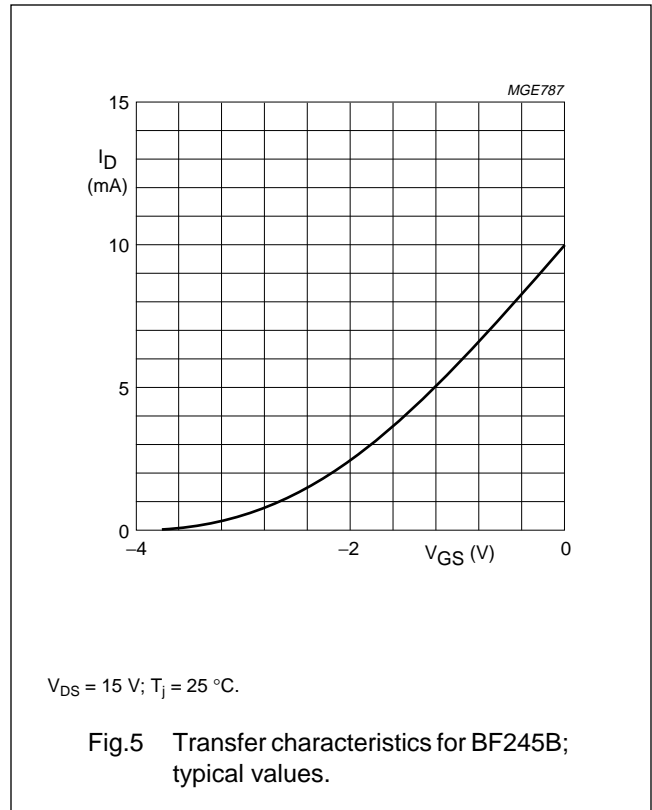
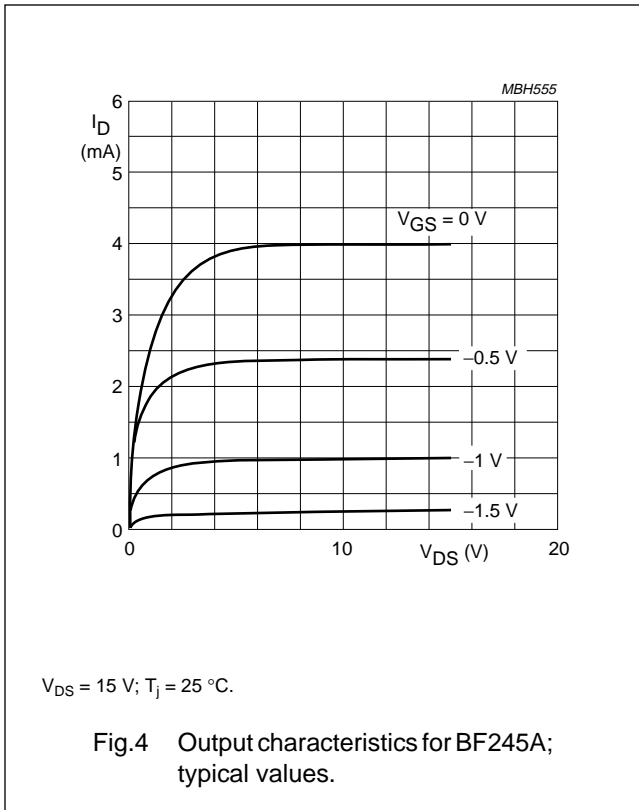

N-channel silicon field-effect transistors

BF245A; BF245B; BF245C

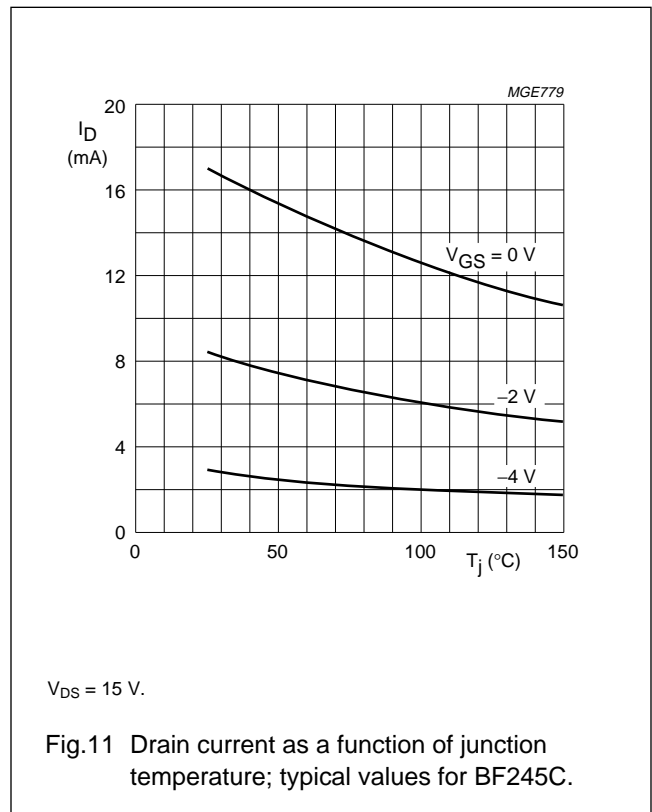
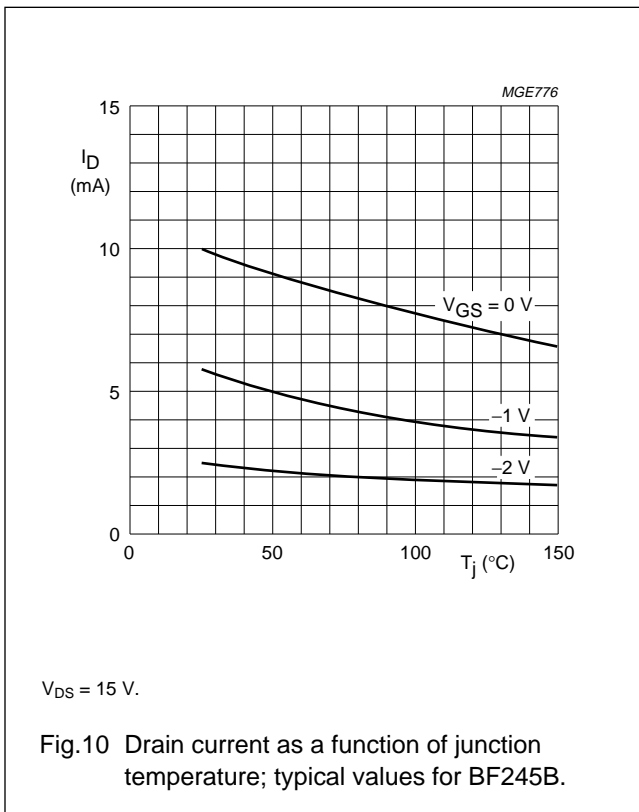
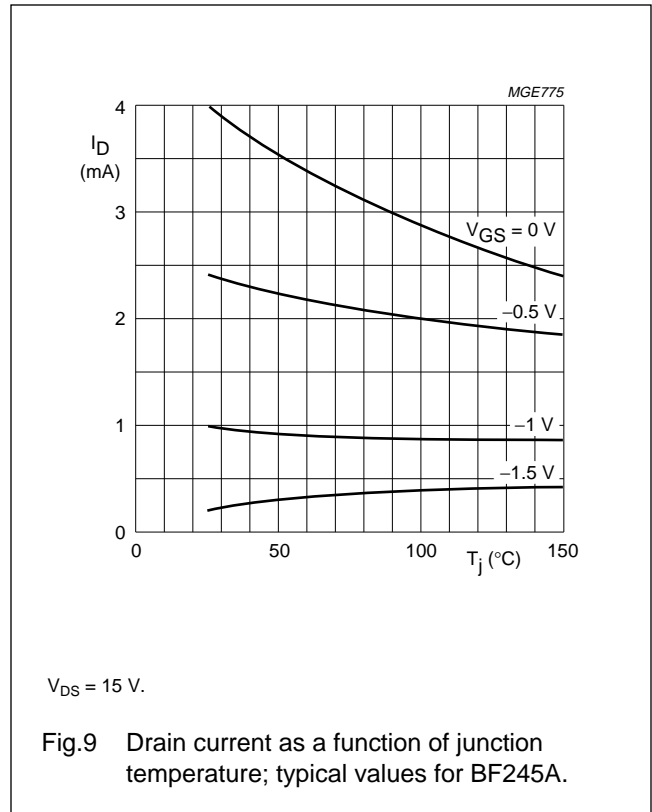
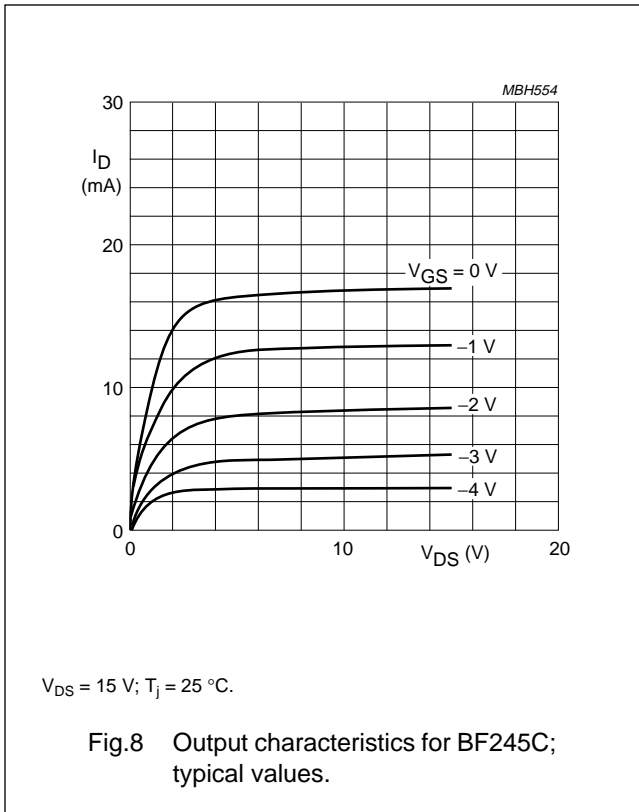

N-channel silicon field-effect transistors

BF245A; BF245B; BF245C

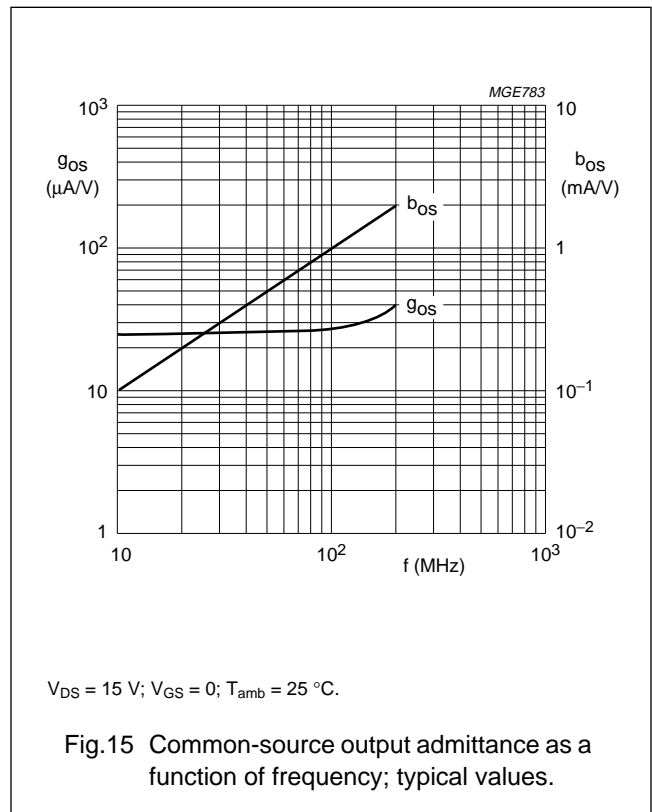
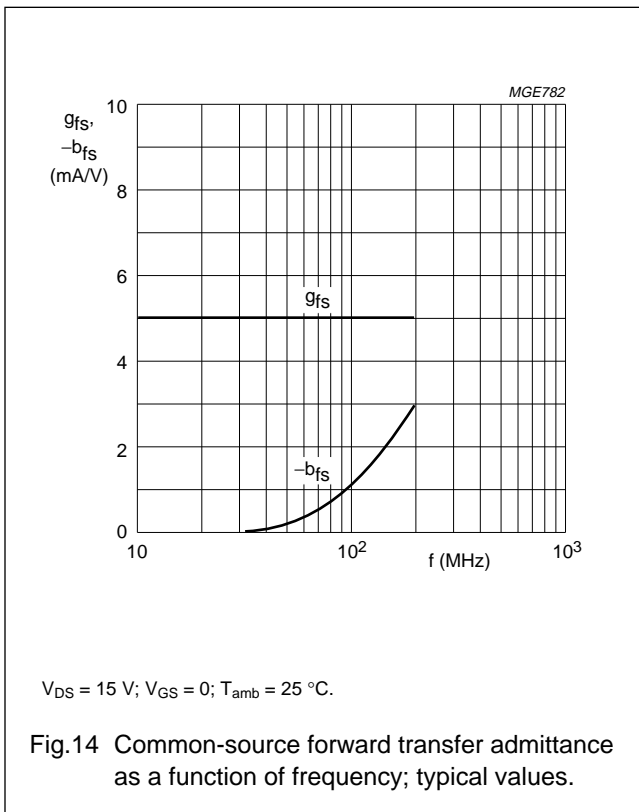
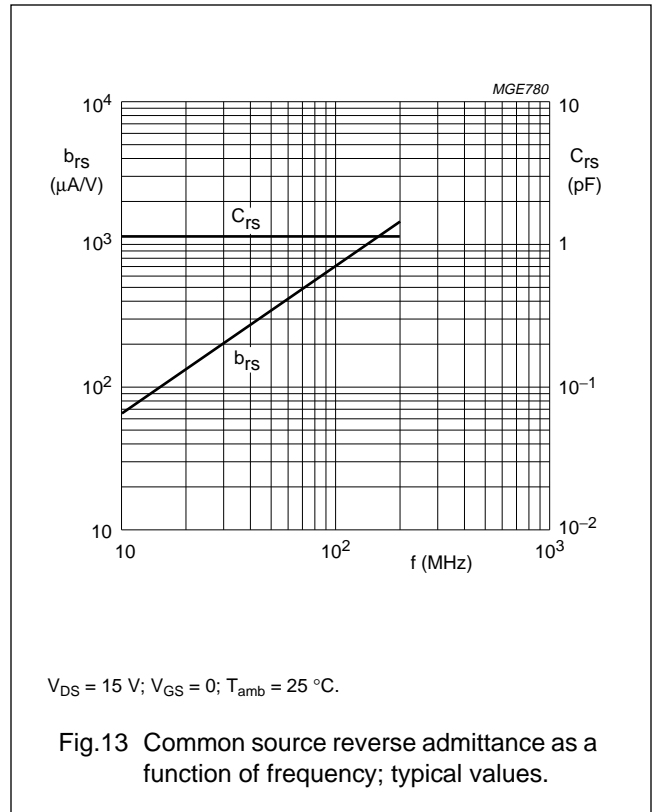
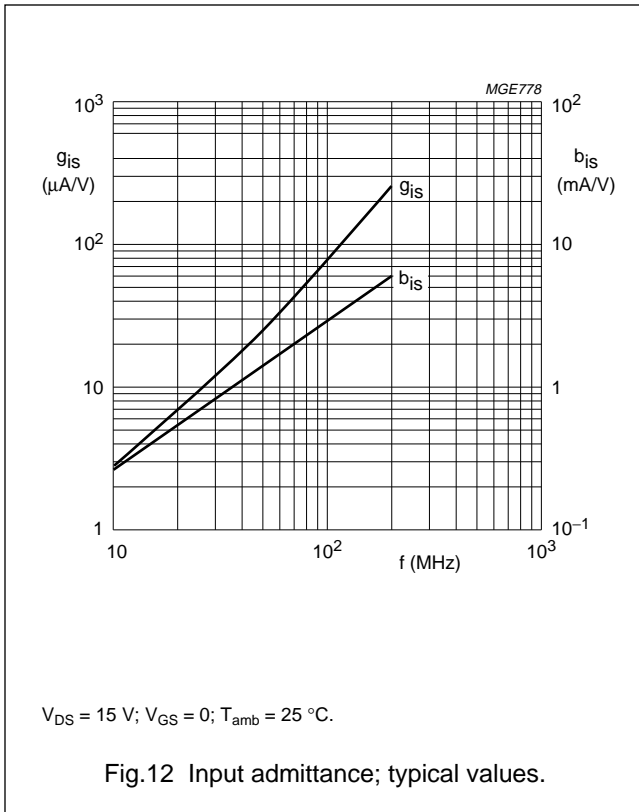

N-channel silicon field-effect transistors

BF245A; BF245B; BF245C

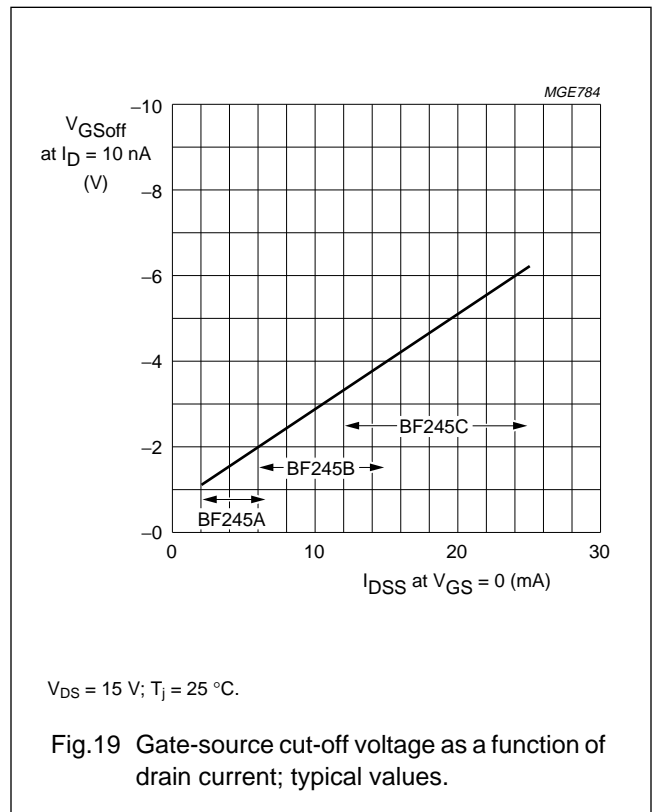
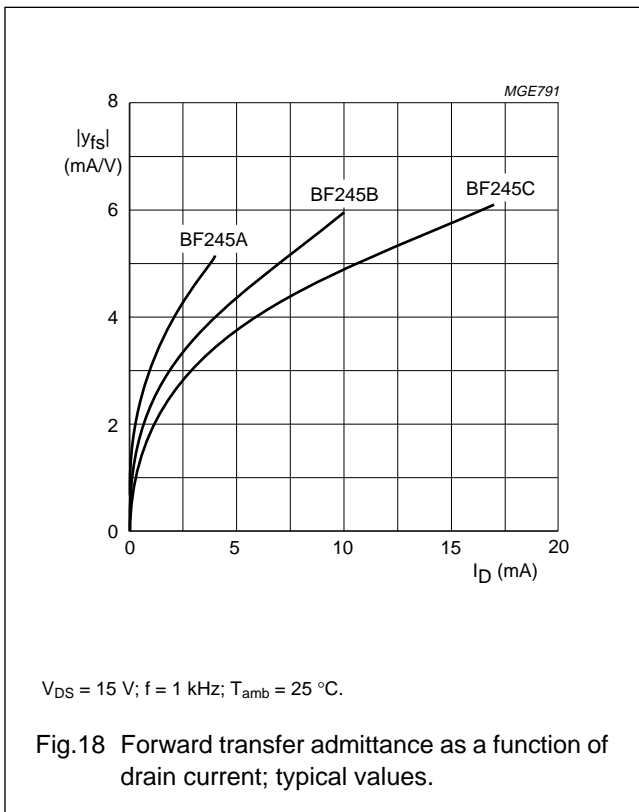
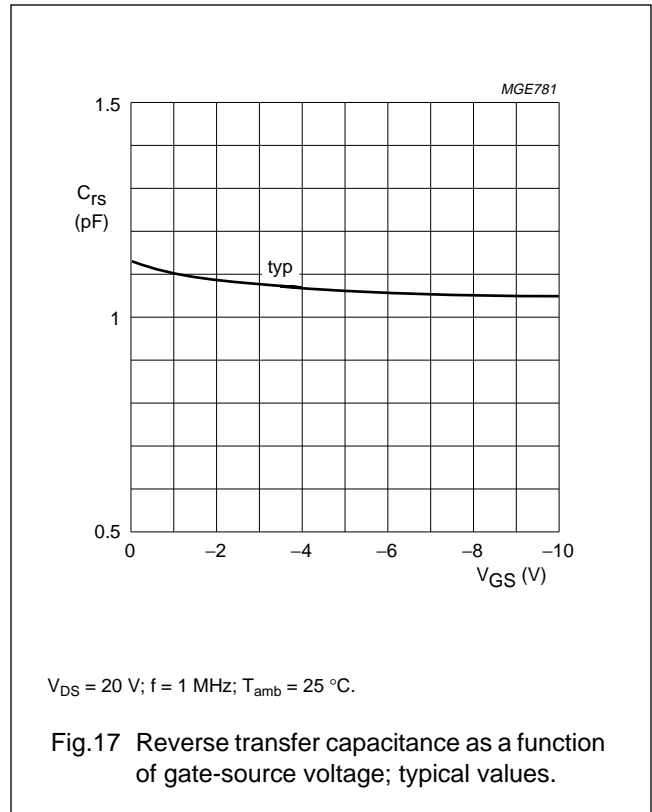
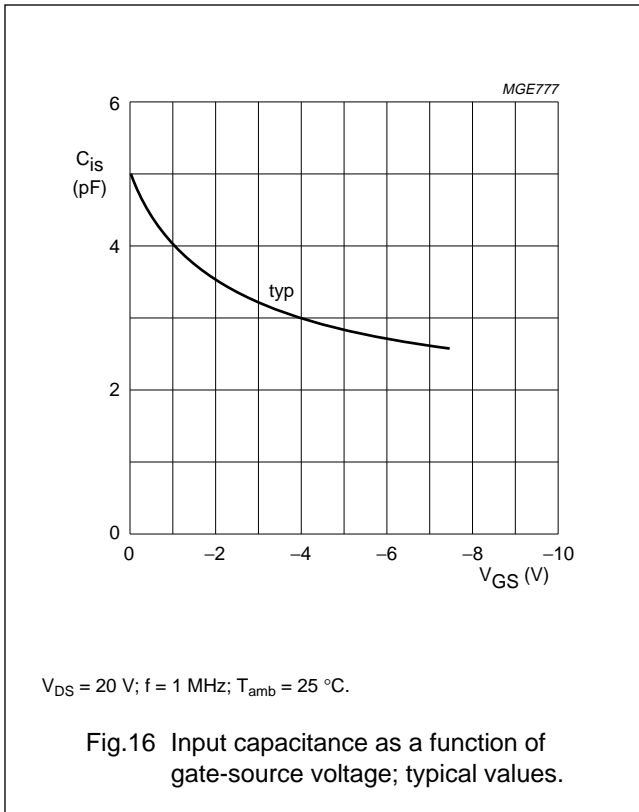

N-channel silicon field-effect transistors

BF245A; BF245B; BF245C

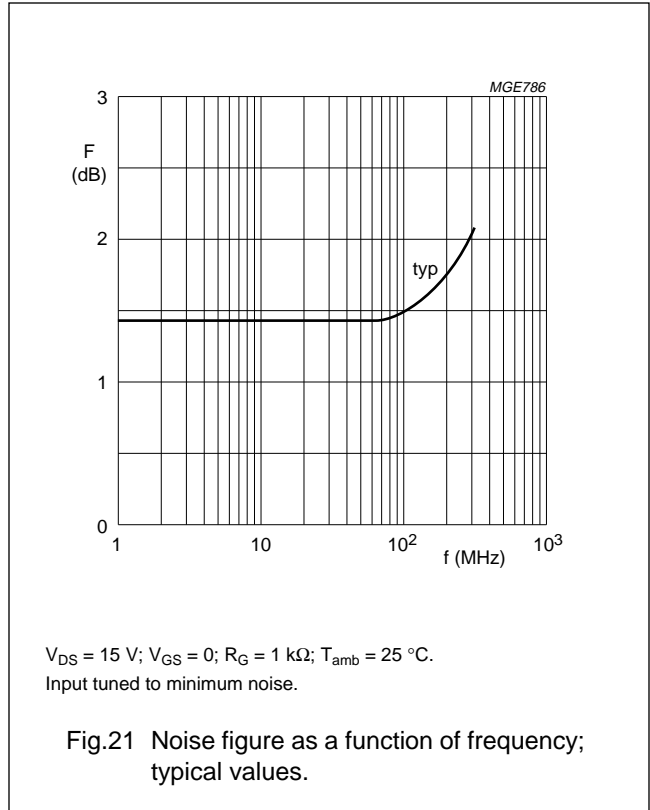
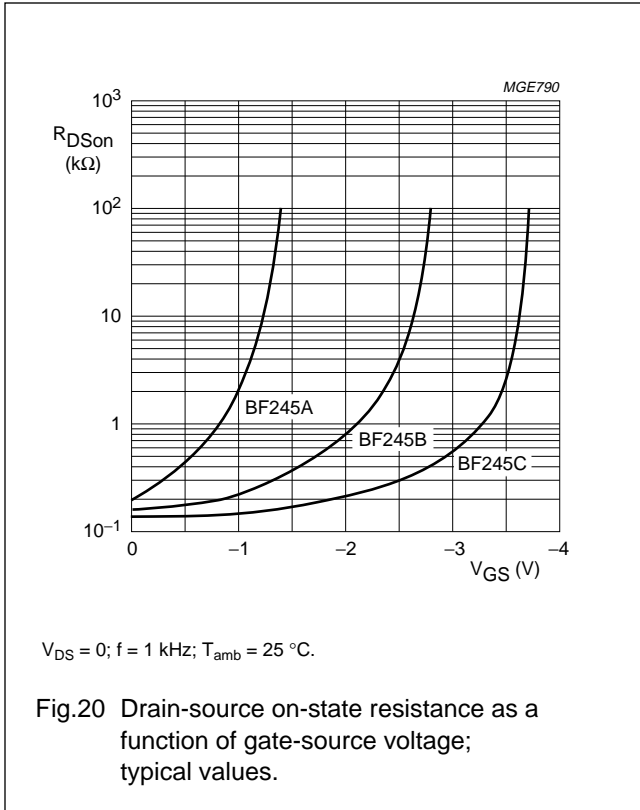

N-channel silicon field-effect transistors

BF245A; BF245B; BF245C

PACKAGE OUTLINE

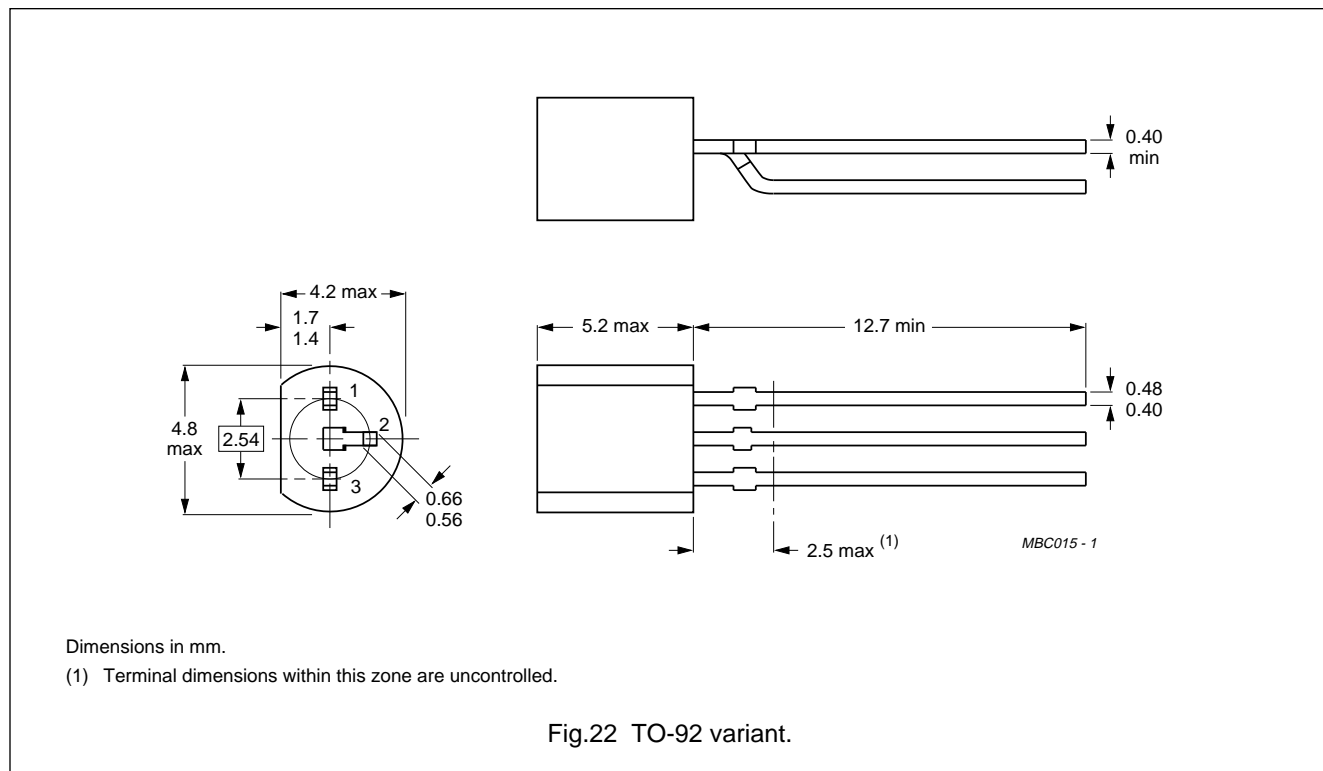

Fig.22 TO-92 variant.

N-channel silicon field-effect transistors

BF245A; BF245B; BF245C

DEFINITIONS

Data Sheet Status	
Objective specification	This data sheet contains target or goal specifications for product development.
Preliminary specification	This data sheet contains preliminary data; supplementary data may be published later.
Product specification	This data sheet contains final product specifications.
Limiting values	
Limiting values given are in accordance with the Absolute Maximum Rating System (IEC 134). Stress above one or more of the limiting values may cause permanent damage to the device. These are stress ratings only and operation of the device at these or at any other conditions above those given in the Characteristics sections of the specification is not implied. Exposure to limiting values for extended periods may affect device reliability.	
Application information	
Where application information is given, it is advisory and does not form part of the specification.	

LIFE SUPPORT APPLICATIONS

These products are not designed for use in life support appliances, devices, or systems where malfunction of these products can reasonably be expected to result in personal injury. Philips customers using or selling these products for use in such applications do so at their own risk and agree to fully indemnify Philips for any damages resulting from such improper use or sale.