

FEATURES

- Low Input Offset Voltage 150 μ V Max
- Low Offset Voltage Drift, Over -55°C to $+125^{\circ}\text{C}$ 1.2 μ V/ $^{\circ}\text{C}$ Max
- Low Supply Current (Per Amplifier) 725 μ A Max
- High Open-Loop Gain 5000V/mV Min
- Input Bias Current 3nA Max
- Low Noise Voltage Density 11nV/ $\sqrt{\text{Hz}}$ at 1kHz
- Stable With Large Capacitive Loads 10nF Typ
- Pin Compatible to OP-11, LM148, HA4741, RM4156, and LT1014 With Improved Performance
- Available in Die Form

ORDERING INFORMATION [†]

| $T_A = +25^{\circ}\text{C}$ V_{OS} MAX (mV) | PACKAGE | | | OPERATING TEMPERATURE RANGE |
|---|------------------|-----------------------|-------------------|-----------------------------|
| | CERDIP 14-PIN | PLASTIC | LCC 28-CONTACT | |
| 150 | OP400AY* | - | OP400ATC/883 | MIL |
| 150 | OP400EY | - | - | IND |
| 230 | OP400FY | - | - | IND |
| 300 | - | OP400GP | - | COM |
| 300 | - | OP400GS ^{††} | - | COM |
| 300 | - | OP400HP | - | XIND |
| 300 | - | OP400HS ^{††} | - | XIND |

* For devices processed in total compliance to MIL-STD-883, add /883 after part number. Consult factory for 883 data sheet.

[†] Burn-in is available on commercial and industrial temperature range parts in CerDIP, plastic DIP, and TO-can packages.

^{††} For availability and burn-in information on SO and PLCC packages, contact your local sales office.

GENERAL DESCRIPTION

The OP-400 is the first monolithic quad operational amplifier that features OP-77 type performance. Precision performance no longer has to be sacrificed to obtain the space and cost savings offered by quad amplifiers.

The OP-400 features an extremely low input offset voltage of less than 150 μ V with a drift of under 1.2 μ V/ $^{\circ}\text{C}$, guaranteed.

PIN CONNECTIONS

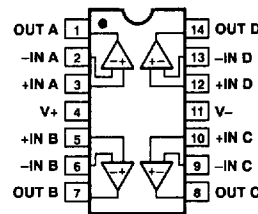

14-PIN HERMETIC DIP (Y-Suffix)

14-PIN PLASTIC DIP (P-Suffix)

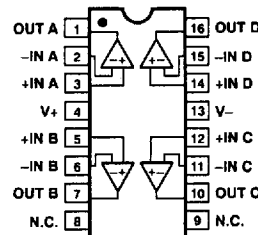

16-PIN SOL (S-Suffix)

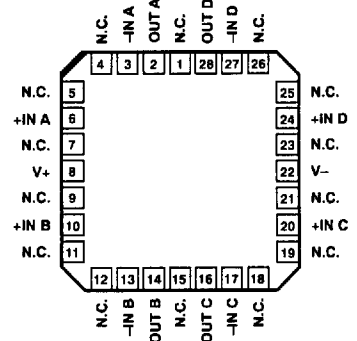

28-LEAD LCC (TC-Suffix)

SIMPLIFIED SCHEMATIC (One of four amplifiers is shown.)

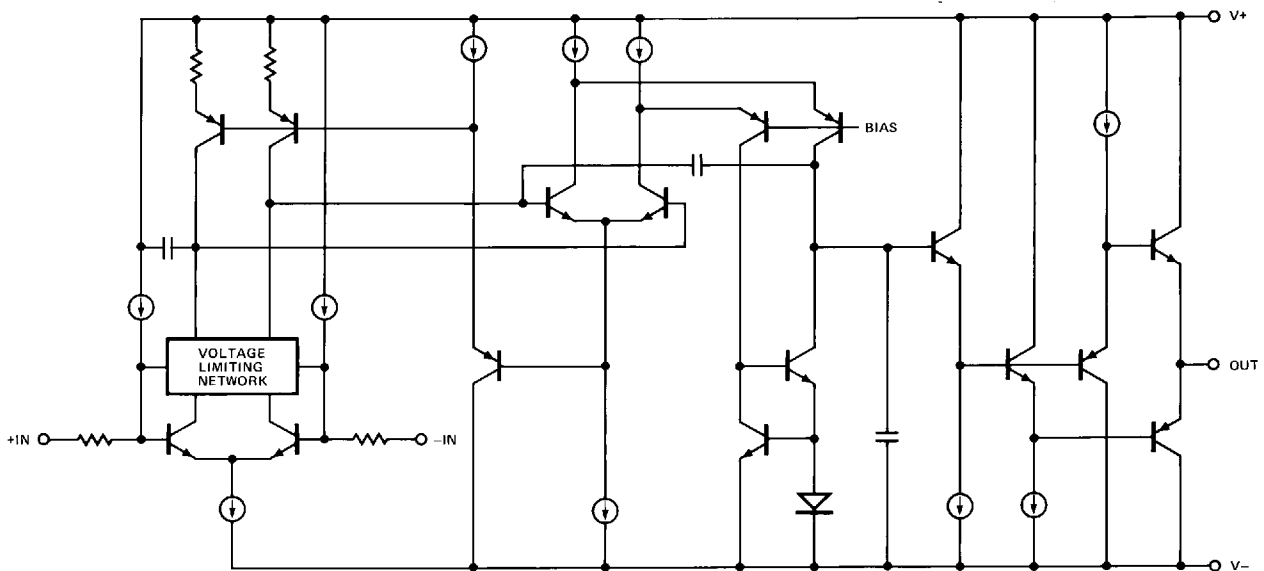

OP-400

over the full military temperature range. Open-loop gain of the OP-400 is over 5,000,000 into a 10k Ω load; input bias current is under 3nA; CMR is above 120dB and PSRR below 1.8 μ V/V. On-chip zener-zap trimming is used to achieve the low input offset voltage of the OP-400 and eliminates the need for offset nulling. (The OP-400 conforms to the industry-standard quad pinout which does not have null terminals.)

The OP-400 features low power consumption, drawing less than 725 μ A per amplifier. The total current drawn by this quad amplifier is less than that of a single OP-07, yet the OP-400 offers significant improvements over this industry-standard op amp. Voltage noise density of the OP-400 is a low 11nV/ $\sqrt{\text{Hz}}$ at 10Hz which is half that of most competitive devices.

The OP-400 is pin compatible with the OP-11, LM148, HA4741, RM4156, and LT1014 operational amplifiers and can be used to upgrade systems using these devices. The OP-400 is an ideal choice for applications requiring multiple precision operational amplifiers and where low power consumption is critical.

ABSOLUTE MAXIMUM RATINGS (Note 2)

| | |
|---|---|
| Supply Voltage | $\pm 20\text{V}$ |
| Differential Input Voltage | $\pm 30\text{V}$ |
| Input Voltage | Supply Voltage |
| Output Short-Circuit Duration | Continuous |
| Storage Temperature Range P, TC, Y-Package | -65°C to $+150^\circ\text{C}$ |

| | |
|---|---|
| Lead Temperature Range (Soldering 60 sec) | 300°C |
| Junction Temperature (T_J) | -65°C to $+150^\circ\text{C}$ |
| Operating Temperature Range | |
| OP-400A | -55°C to $+125^\circ\text{C}$ |
| OP-400E, OP-400F | -25°C to $+85^\circ\text{C}$ |
| OP-400G | 0°C to $+70^\circ\text{C}$ |
| OP-400H | -40°C to $+85^\circ\text{C}$ |

| PACKAGE TYPE | θ_{JA} (Note 1) | θ_{JC} | UNITS |
|-------------------------|------------------------|---------------|--------------------|
| 14-Pin Hermetic DIP (Y) | 94 | 10 | $^\circ\text{C/W}$ |
| 14-Pin Plastic DIP (P) | 76 | 33 | $^\circ\text{C/W}$ |
| 28-Contact LCC (TC) | 70 | 28 | $^\circ\text{C/W}$ |
| 16-Pin SOL (S) | 88 | 23 | $^\circ\text{C/W}$ |

NOTES:

- θ_{JA} is specified for worst case mounting conditions, i.e., θ_{JA} is specified for device in socket for TO, CerDIP, P-DIP, and LCC packages; θ_{JA} is specified for device soldered to printed circuit board for SO package.
- Absolute maximum ratings apply to both DICE and packaged parts, unless otherwise noted.

ELECTRICAL CHARACTERISTICS at $V_S = \pm 15\text{V}$, $T_A = +25^\circ\text{C}$, unless otherwise noted.

| PARAMETER | SYMBOL | CONDITIONS | OP-400A/E | | | OP-400F | | | OP-400G/H | | | UNITS |
|------------------------------------|--------------------|---|-----------|-------|-----|---------|------|-----|-----------|------|-----|------------------------------|
| | | | MIN | TYP | MAX | MIN | TYP | MAX | MIN | TYP | MAX | |
| Input Offset Voltage | V_{OS} | | — | 40 | 150 | — | 60 | 230 | — | 80 | 300 | μV |
| Long Term Input Voltage Stability | | | — | 0.1 | — | — | 0.1 | — | — | 0.1 | — | $\mu\text{V}/\text{mo}$ |
| Input Offset Current | I_{OS} | $V_{CM} = 0\text{V}$ | — | 0.1 | 1.0 | — | 0.1 | 2.0 | — | 0.1 | 3.5 | nA |
| Input Bias Current | I_B | $V_{CM} = 0\text{V}$ | — | 0.75 | 3.0 | — | 0.75 | 6.0 | — | 0.75 | 7.0 | nA |
| Input Noise Voltage | $e_{n\text{ p-p}}$ | 0.1Hz to 10Hz | — | 0.5 | — | — | 0.5 | — | — | 0.5 | — | $\mu\text{V}_{\text{p-p}}$ |
| Input Noise Voltage Density | e_n | $f_O = 10\text{Hz}$ | — | 22 | 36 | — | 22 | 36 | — | 22 | — | $\text{nV}/\sqrt{\text{Hz}}$ |
| | | $f_O = 1000\text{Hz}$ (Note 1) | — | 11 | 18 | — | 11 | 18 | — | 11 | — | |
| Input Noise Current | $i_{n\text{ p-p}}$ | 0.1Hz to 10Hz | — | 15 | — | — | 15 | — | — | 15 | — | $\text{pA}_{\text{p-p}}$ |
| Input Noise Current Density | i_n | $f_O = 10\text{Hz}$ | — | 0.6 | — | — | 0.6 | — | — | 0.6 | — | $\text{pA}/\sqrt{\text{Hz}}$ |
| Input Resistance Differential Mode | R_{IN} | | — | 10 | — | — | 10 | — | — | 10 | — | $\text{M}\Omega$ |
| Input Resistance Common Mode | R_{INCM} | | — | 200 | — | — | 200 | — | — | 200 | — | $\text{G}\Omega$ |
| Large Signal Voltage Gain | A_{VO} | $V_O = \pm 10\text{V}$ | 5000 | 12000 | — | 3000 | 7000 | — | 3000 | 7000 | — | V/mV |
| | | $R_L = 10\text{k}\Omega$ $R_L = 2\text{k}\Omega$ | 2000 | 3500 | — | 1500 | 3000 | — | 1500 | 3000 | — | |

ELECTRICAL CHARACTERISTICS at $V_S = \pm 15V$, $T_A = +25^\circ C$, unless otherwise noted. (Continued)

| PARAMETER | SYMBOL | CONDITIONS | OP-400A/E | | | OP-400F | | | OP-400G/H | | | UNITS |
|------------------------------|----------|--|----------------------|--------------------------|-----|----------------------|--------------------------|-----|----------------------|--------------------------|-----|------------|
| | | | MIN | TYP | MAX | MIN | TYP | MAX | MIN | TYP | MAX | |
| Input Voltage Range | IVR | Note 3 | ± 12 | ± 13 | — | ± 12 | ± 13 | — | ± 12 | ± 13 | — | V |
| Common Mode Rejection | CMR | $V_{CM} = \pm 12V$ | 120 | 140 | — | 115 | 140 | — | 110 | 135 | — | dB |
| Power Supply Rejection Ratio | PSRR | $V_S = \pm 3V$ to $\pm 18V$ | — | 0.1 | 1.8 | — | 0.1 | 3.2 | — | 0.2 | 5.6 | $\mu V/V$ |
| Output Voltage Swing | V_O | $R_L = 10k\Omega$ $R_L = 2k\Omega$ | ± 12 ± 11 | ± 12.6 ± 12.2 | — | ± 12 ± 11 | ± 12.6 ± 12.2 | — | ± 12 ± 11 | ± 12.6 ± 12.2 | — | V |
| Supply Current Per Amplifier | I_{SY} | No Load | — | 600 | 725 | — | 600 | 725 | — | 600 | 725 | μA |
| Slew Rate | SR | | 0.1 | 0.15 | — | 0.1 | 0.15 | — | 0.1 | 0.15 | — | V/ μs |
| Gain Bandwidth Product | GBWP | $A_V = +1$ | — | 500 | — | — | 500 | — | — | 500 | — | kHz |
| Channel Separation | CS | $V_O = 20V_{p-p}$ $f_O = 10Hz$ (Note 2) | 123 | 135 | — | 123 | 135 | — | 123 | 135 | — | dB |
| Input Capacitance | C_{IN} | | — | 3.2 | — | — | 3.2 | — | — | 3.2 | — | pF |
| Capacitive Load Stability | | $A_V = +1$ No Oscillations | — | 10 | — | — | 10 | — | — | 10 | — | nF |

NOTES:

1. Sample tested.
2. Guaranteed but not 100% tested.
3. Guaranteed by CMR test.

ELECTRICAL CHARACTERISTICS at $V_S = \pm 15V$, $-55^\circ C \leq T_A \leq 125^\circ C$ for OP-400A, unless otherwise noted.

| PARAMETER | SYMBOL | CONDITIONS | OP-400A | | | UNITS |
|------------------------------------|------------|---|----------------------|------------------------|-----|------------------|
| | | | MIN | TYP | MAX | |
| Input Offset Voltage | V_{OS} | | — | 70 | 270 | μV |
| Average Input Offset Voltage Drift | TCV_{OS} | | — | 0.3 | 1.2 | $\mu V/^\circ C$ |
| Input Offset Current | I_{OS} | $V_{CM} = 0V$ | — | 0.1 | 2.5 | nA |
| Input Bias Current | I_B | $V_{CM} = 0V$ | — | 1.3 | 5.0 | nA |
| Large Signal Voltage Gain | A_{VO} | $V_O = \pm 10V$ $R_L = 10k\Omega$ $R_L = 2k\Omega$ | 3000 1000 | 9000 2300 | — | V/mV |
| Input Voltage Range | IVR | Note 1 | ± 12 | ± 12.5 | — | V |
| Common Mode Rejection | CMR | $V_{CM} = \pm 12V$ | 115 | 130 | — | dB |
| Power Supply Rejection Ratio | PSRR | $V_S = +3V$ to $\pm 18V$ | — | 0.2 | 3.2 | $\mu V/V$ |
| Output Voltage Swing | V_O | $R_L = 10k\Omega$ $R_L = 2k\Omega$ | ± 12 ± 11 | ± 12.4 ± 12 | — | V |
| Supply Current Per Amplifier | I_{SY} | No Load | — | 600 | 775 | μA |
| Capacitive Load Stability | | $A_V = +1$ No Oscillations | — | 8 | — | nF |

NOTE:

1. Guaranteed by CMR test.

OP-400

ELECTRICAL CHARACTERISTICS at $V_S = \pm 15V$, $-25^\circ C \leq T_A \leq \pm 85^\circ C$ for OP-400E/F, $0^\circ C \leq T_A \leq +70^\circ C$ for OP-400G, $-40^\circ C \leq T_A \leq +85^\circ C$ for OP-400H, unless otherwise noted.

| PARAMETER | SYMBOL | CONDITIONS | OP-400E | | | OP-400F | | | OP-400G/H | | | UNITS |
|------------------------------------|------------|--|----------|------------|-----|----------|------------|------|-----------|------------|------|------------------|
| | | | MIN | TYP | MAX | MIN | TYP | MAX | MIN | TYP | MAX | |
| Input Offset Voltage | V_{OS} | | – | 60 | 220 | – | 80 | 350 | – | 110 | 400 | μV |
| Average Input Offset Voltage Drift | TCV_{OS} | | – | 0.3 | 1.2 | – | 0.3 | 2.0 | – | 0.6 | 2.5 | $\mu V/^\circ C$ |
| Input Offset Current | I_{OS} | $V_{CM} = 0V$ E, F, G Grades H Grade | – | 0.1 | 2.5 | – | 0.1 | 3.5 | – | 0.2 | 6.0 | nA |
| Input Bias Current | I_B | $V_{CM} = 0V$ E, F, G Grades H Grade | – | 0.9 | 5.0 | – | 0.9 | 10.0 | – | 1.0 | 12.0 | nA |
| Large-Signal Voltage Gain | A_{VO} | $V_O = \pm 10V$ $R_L = 10k\Omega$ $R_L = 2k\Omega$ | 3000 | 10000 | – | 2000 | 5000 | – | 2000 | 5000 | – | V/mV |
| | | | 1500 | 2700 | – | 1000 | 2000 | – | 1000 | 2000 | – | |
| Input Voltage Range | IVR | (Note 1) | ± 12 | ± 12.5 | – | ± 12 | ± 12.5 | – | ± 12 | ± 12.5 | – | V |
| Common-Mode Rejection | CMR | $V_{CM} = \pm 12V$ | 115 | 135 | – | 110 | 135 | – | 105 | 130 | – | dB |
| Power Supply Rejection Ratio | PSRR | $V_S = \pm 3V$ to $\pm 18V$ | – | 0.15 | 3.2 | – | 0.15 | 5.6 | – | 0.3 | 10.0 | $\mu V/V$ |
| Output Voltage Swing | V_O | $R_L = 10k\Omega$ $R_L = 2k\Omega$ | ± 12 | ± 12.4 | – | ± 12 | ± 12.4 | – | ± 12 | ± 12.6 | – | V |
| | | | ± 11 | ± 12 | – | ± 11 | ± 12 | – | ± 11 | ± 12.2 | – | |
| Supply Current Per Amplifier | I_{SY} | No Load | – | 600 | 775 | – | 600 | 775 | – | 600 | 775 | μA |
| Capacitive Load Stability | | $A_V = +1$ No Oscillations | – | 10 | – | – | 10 | – | – | 10 | – | nF |

NOTE:

1. Guaranteed by CMR test.

DICE CHARACTERISTICS

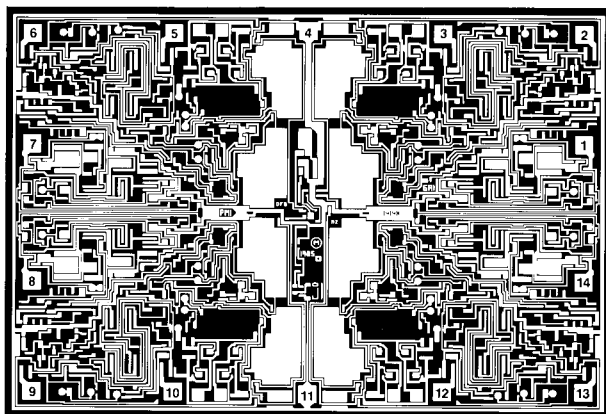

DIE SIZE 0.181 × 0.123 inch, 22,263 sq. mils
(4.60 × 3.12 mm, 14.35 sq. mm)

- | | |
|----------|-----------|
| 1. OUT A | 8. OUT C |
| 2. -IN A | 9. -IN C |
| 3. +IN A | 10. +IN C |
| 4. V+ | 11. V- |
| 5. +IN B | 12. +IN D |
| 6. -IN B | 13. -IN D |
| 7. OUT B | 14. OUT D |

WAFER TEST LIMITS at $V_S = \pm 15V$, $T_A = +25^\circ C$, unless otherwise noted.

| PARAMETER | SYMBOL | CONDITIONS | OP-400GBC LIMIT | UNITS |
|---------------------------------|----------|-----------------------------------|--------------------|---------------|
| Input Offset Voltage | V_{OS} | | 230 | μV MAX |
| Input Offset Current | I_{OS} | $V_{CM} = 0V$ | 2 | nA MAX |
| Input Bias Current | I_B | $V_{CM} = 0V$ | 6 | nA MAX |
| Large Signal Voltage Gain | A_{VO} | $V_O = \pm 10V$ $R_L = 10k\Omega$ | 3000 | V/mV MIN |
| | | $R_L = 2k\Omega$ | 1500 | |
| Input Voltage Range | IVR | Note 1 | ± 12 | V MIN |
| Common Mode Rejection | CMR | $V_{CM} = \pm 12V$ | 115 | dB MIN |
| Power Supply Rejection Ratio | PSRR | $V_S = \pm 3V$ to $\pm 18V$ | 3.2 | $\mu V/V$ MAX |
| Output Voltage Swing | V_O | $R_L = 10k\Omega$ | ± 12 | V MIN |
| | | $R_L = 2k\Omega$ | ± 11 | |
| Supply Current Per Amplifier | I_{SY} | No Load | 725 | μA MAX |

NOTES:

1. Guaranteed by CMR test.

Electrical tests are performed at wafer probe to the limits shown. Due to variations in assembly methods and normal yield loss, yield after packaging is not guaranteed for standard product dice. Consult factory to negotiate specifications based on dice lot qualification through sample lot assembly and testing.

OP-400

TYPICAL PERFORMANCE CHARACTERISTICS

WARM-UP DRIFT

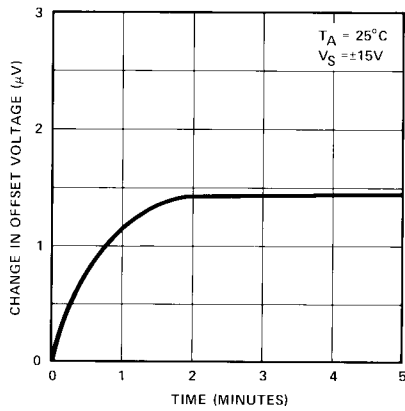

INPUT OFFSET VOLTAGE vs TEMPERATURE

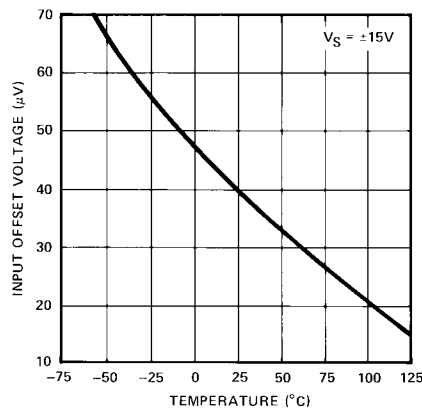

INPUT BIAS CURRENT vs TEMPERATURE

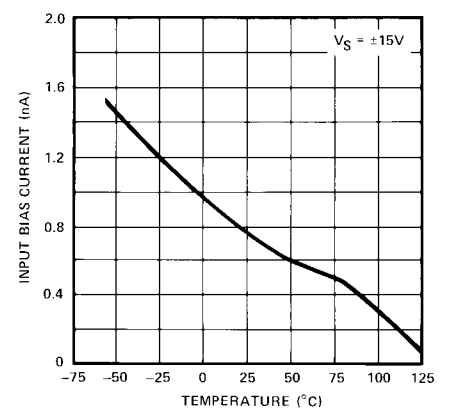

INPUT OFFSET CURRENT vs TEMPERATURE

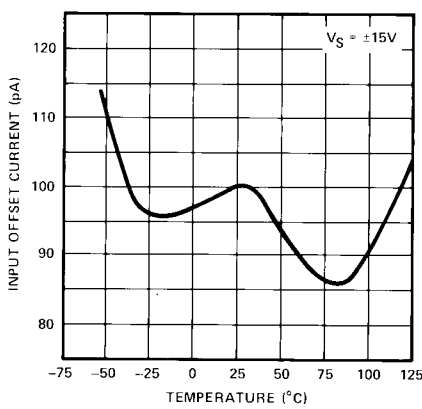

INPUT BIAS CURRENT vs COMMON-MODE VOLTAGE

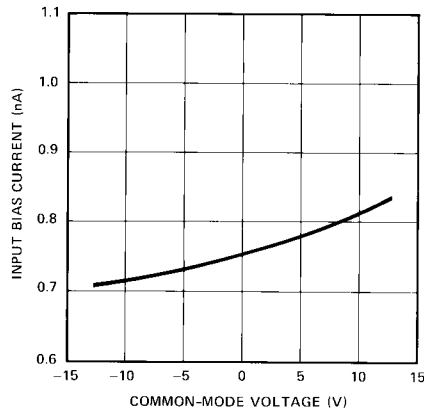

COMMON-MODE REJECTION vs FREQUENCY

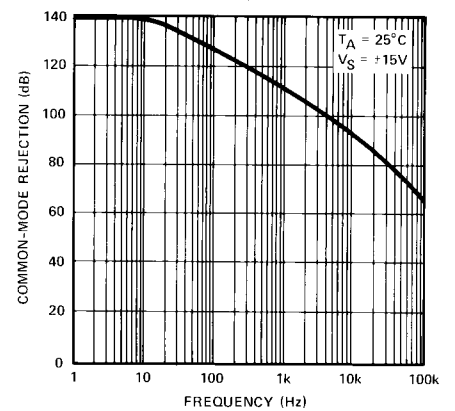

NOISE VOLTAGE DENSITY vs FREQUENCY

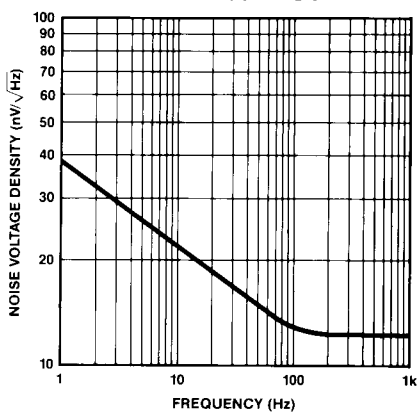

CURRENT NOISE DENSITY vs FREQUENCY

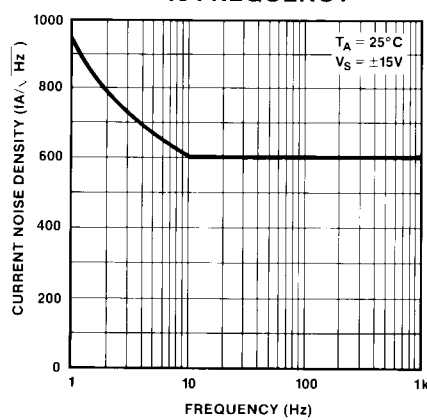

0.1Hz TO 10Hz NOISE

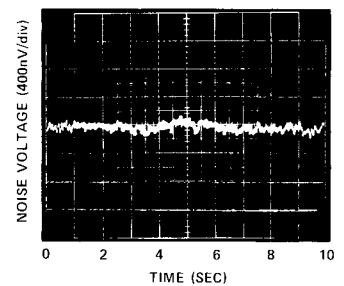

TYPICAL PERFORMANCE CHARACTERISTICS

TOTAL SUPPLY CURRENT vs SUPPLY VOLTAGE

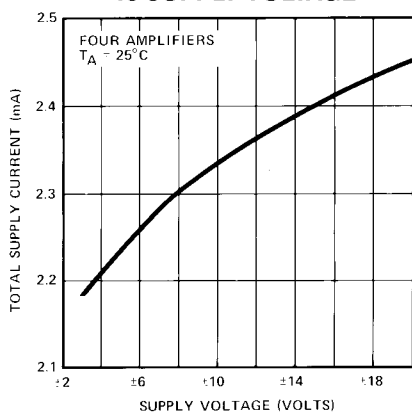

TOTAL SUPPLY CURRENT vs TEMPERATURE

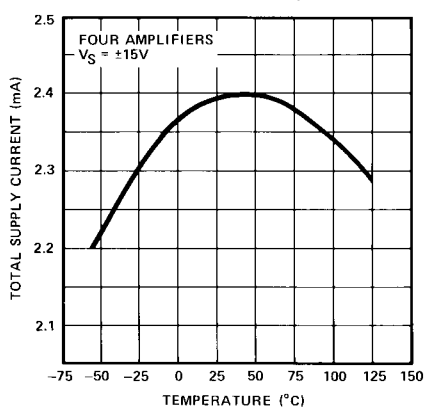

POWER SUPPLY REJECTION vs FREQUENCY

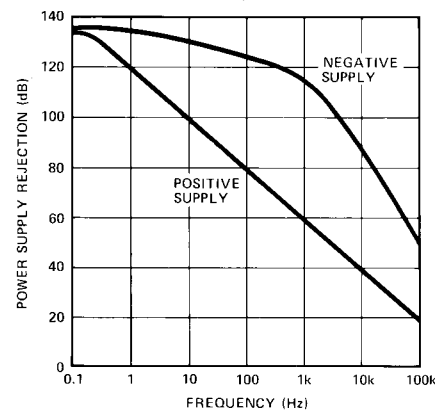

POWER SUPPLY REJECTION vs TEMPERATURE

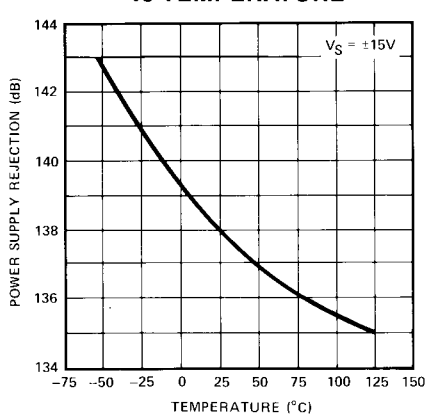

OPEN-LOOP GAIN vs TEMPERATURE

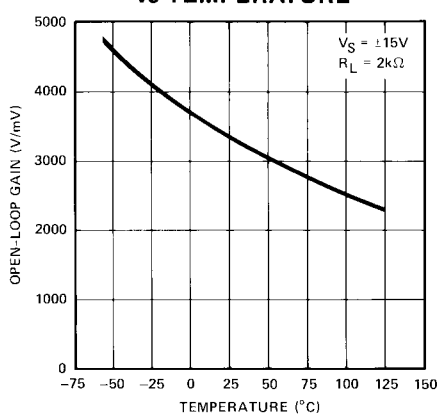

OPEN-LOOP GAIN AND PHASE SHIFT vs FREQUENCY

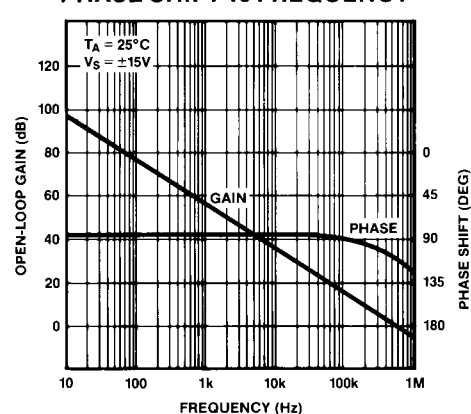

CLOSED-LOOP GAIN vs FREQUENCY

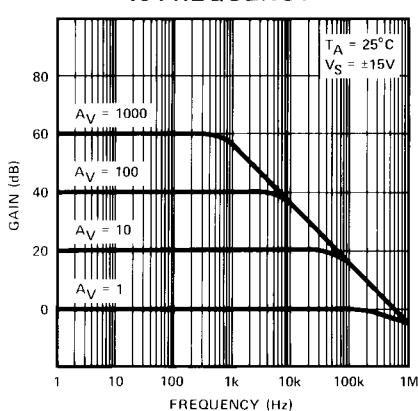

MAXIMUM OUTPUT SWING vs FREQUENCY

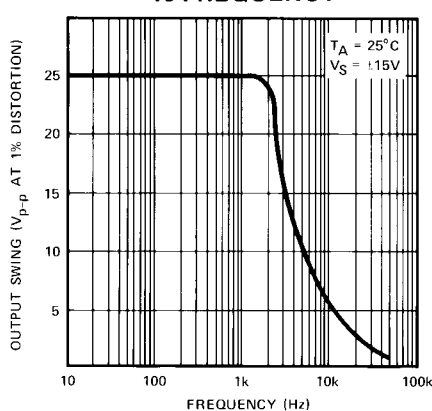

TOTAL HARMONIC DISTORTION vs FREQUENCY

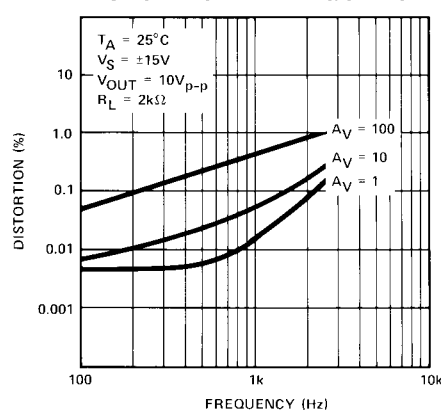

OP-400

TYPICAL PERFORMANCE CHARACTERISTICS

OVERSHOOT vs CAPACITIVE LOAD

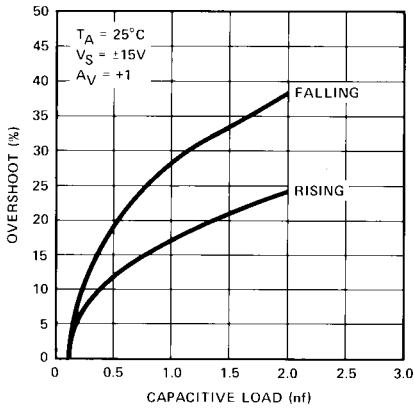

SHORT-CIRCUIT CURRENT vs TIME

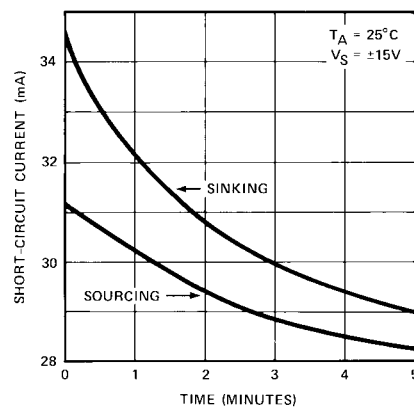

CHANNEL SEPARATION vs FREQUENCY

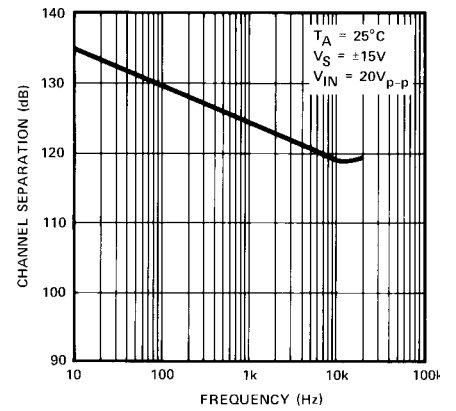

LARGE-SIGNAL TRANSIENT RESPONSE

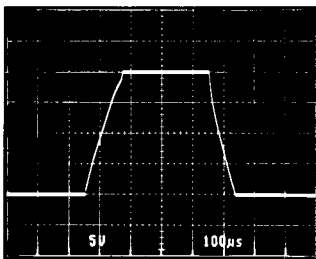

$T_A = 25^\circ\text{C}$
 $V_S = \pm 15\text{V}$
 $A_V = +1$

SMALL-SIGNAL TRANSIENT RESPONSE

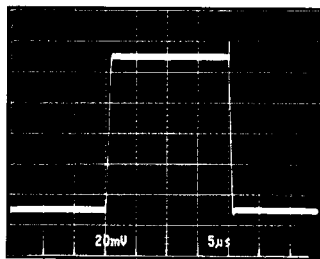

$T_A = 25^\circ\text{C}$
 $V_S = \pm 15\text{V}$
 $A_V = +1$

SMALL-SIGNAL TRANSIENT RESPONSE
 $C_{LOAD} = 1\text{nF}$

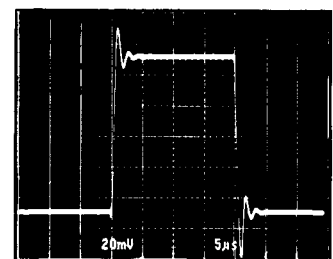

$T_A = 25^\circ\text{C}$
 $V_S = \pm 15\text{V}$
 $A_V = +1$

NOISE TEST SCHEMATIC

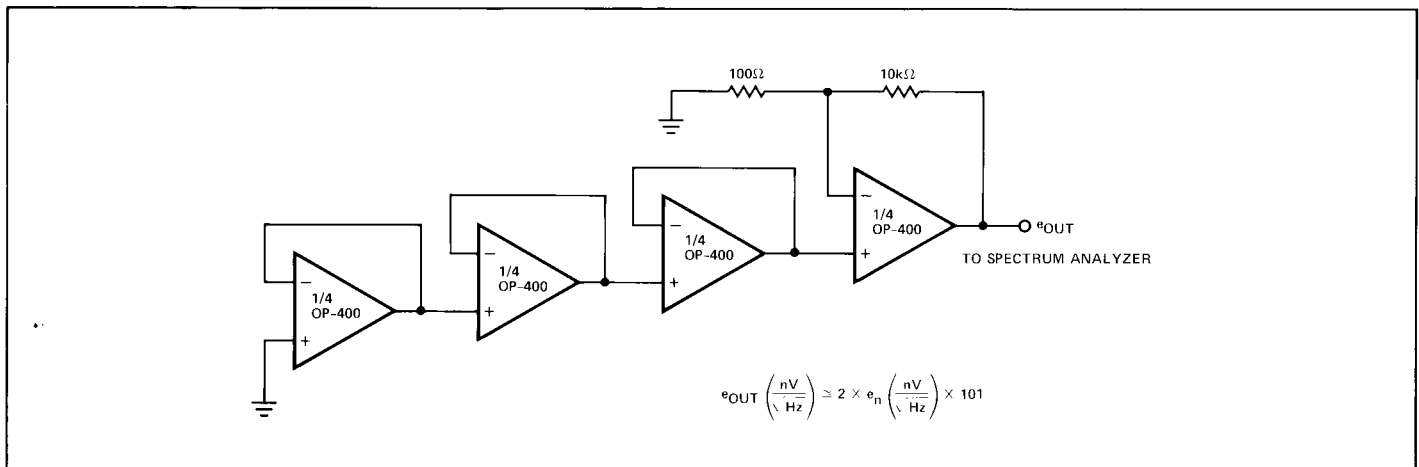

BURN-IN CIRCUIT

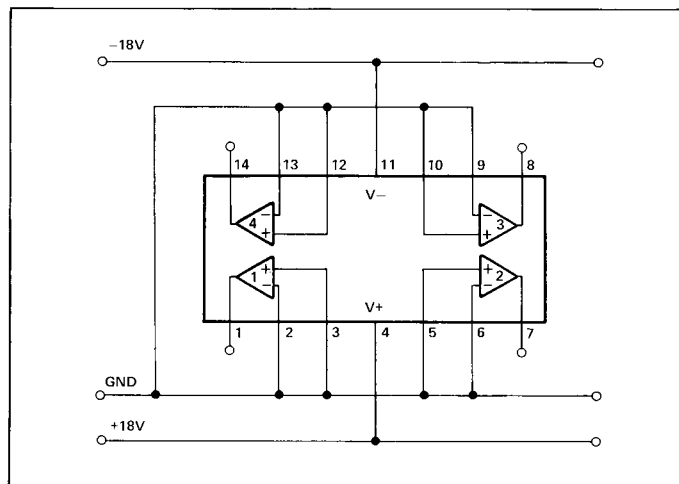

APPLICATIONS INFORMATION

The OP-400 is inherently stable at all gains and is capable of driving large capacitive loads without oscillating. Nonetheless, good supply decoupling is highly recommended. Proper supply decoupling reduces problems caused by supply line noise and improves the capacitive load driving capability of the OP-400.

Total supply current can be reduced by connecting the inputs of an unused amplifier to V-. This turns the amplifier off, lowering the total supply current.

APPLICATIONS

DUAL LOW-POWER INSTRUMENTATION AMPLIFIER

A dual instrumentation amplifier that consumes less than 33mW of power per channel is shown in Figure 1. The linearity of the instrumentation amplifier exceeds 16 bits in gains of 5 to 200 and is better than 14 bits in gains from 200 to 1000. CMRR is above 115dB (Gain = 1000). Offset voltage drift is typically 0.4μV/°C over the military temperature range

which is comparable to the best monolithic instrumentation amplifiers. The bandwidth of the low-power instrumentation amplifier is a function of gain and is shown below:

| GAIN | BANDWIDTH |
|------|-----------|
| 5 | 150kHz |
| 10 | 67kHz |
| 100 | 7.5kHz |
| 1000 | 500Hz |

The output signal is specified with respect to the reference input, which is normally connected to analog ground. The reference input can be used to offset the output from -10V to +10V if required.

FIGURE 1: Dual Low-Power Instrumentation Amplifier

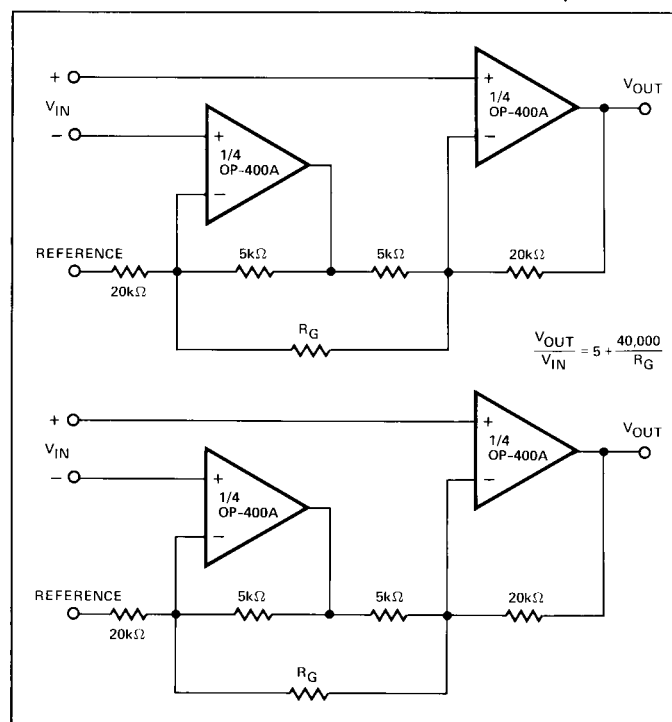

OP-400

FIGURE 2: Bipolar Current Transmitter

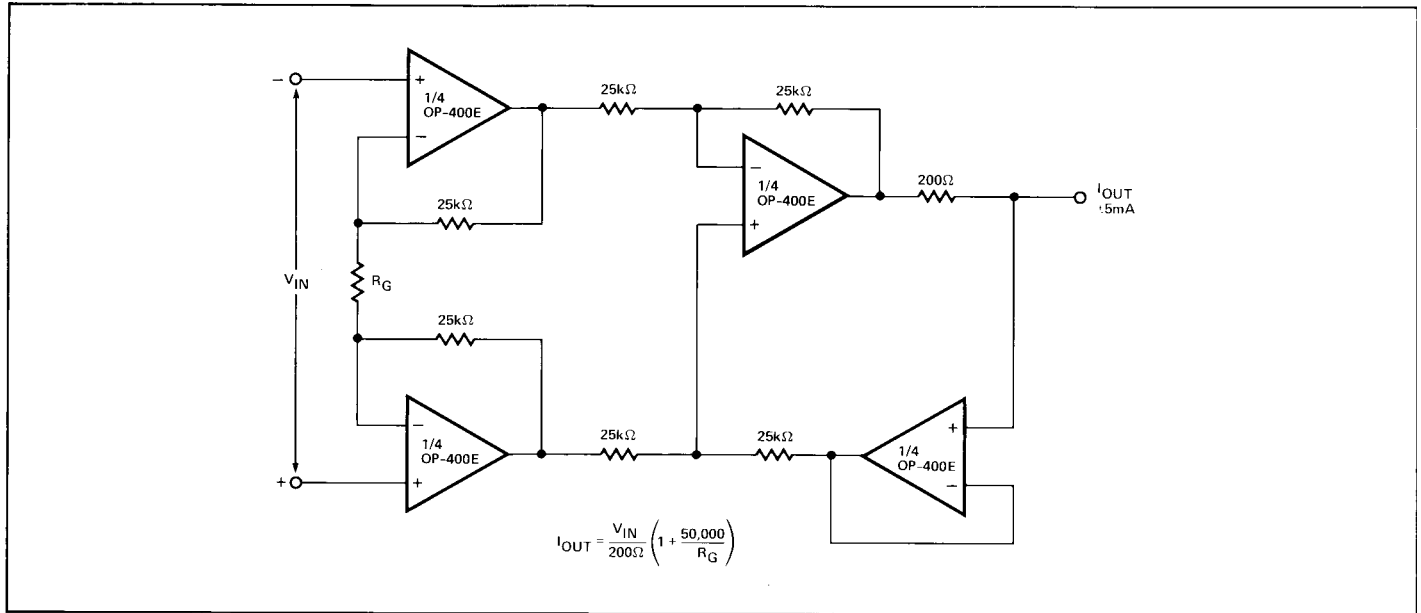

BIPOLAR CURRENT TRANSMITTER

In the circuit of Figure 2, which is an extension of the standard three op-amp instrumentation amplifier, the output current is proportional to the differential input voltage. Maximum output current is $\pm 5\text{mA}$ with voltage compliance equal to $\pm 10\text{V}$ when using $\pm 15\text{V}$ supplies. Output impedance of the current transmitter exceeds $3\text{M}\Omega$ and linearity is better than 16 bits with gain set for a full scale input of $\pm 100\mu\text{V}$.

DIFFERENTIAL OUTPUT INSTRUMENTATION AMPLIFIER

The output voltage swing of a single-ended instrumentation amplifier is limited by the supplies, normally at $\pm 15\text{V}$, to a maximum of $24\text{V}_{\text{p-p}}$. The differential output instrumentation amplifier of Figure 3 can provide an output voltage swing of $48\text{V}_{\text{p-p}}$ when operated with $\pm 15\text{V}$ supplies. The extended output swing is due to the opposite polarity of the outputs. Both outputs will swing $24\text{V}_{\text{p-p}}$ but with opposite polarity, for a total output voltage swing of $48\text{V}_{\text{p-p}}$. The reference input can be used to set a common-mode output voltage over the range $\pm 10\text{V}$. PSRR of the amplifier is less than $1\mu\text{V}/\text{V}$ with CMRR (Gain = 1000) better than 115dB. Offset voltage drift is typically $0.4\mu\text{V}/^\circ\text{C}$ over the military temperature range.

FIGURE 3: Differential Output Instrumentation Amplifier

