

Darlington Complementary Silicon Power Transistors

... designed for general purpose and low speed switching applications.

- High DC Current Gain — $h_{FE} = 2500$ (typ.) at $I_C = 4.0$
- Collector-Emitter Sustaining Voltage at 100 mA dc
 $V_{CE(sus)} = 80$ Vdc (min.) — BDX33B, 34B
 100 Vdc (min.) — BDX33C, 34C
- Low Collector-Emitter Saturation Voltage
 $V_{CE(sat)} = 2.5$ Vdc (max.) at $I_C = 3.0$ A dc — BDX33B, 33C/34B, 34C
- Monolithic Construction with Build-In Base-Emitter Shunt resistors
- TO-220AB Compact Package

MAXIMUM RATINGS

Rating	Symbol	BDX33B BDX34B	BDX33C BDX34C	Unit
Collector-Emitter Voltage	V_{CEO}	80	100	Vdc
Collector-Base Voltage	V_{CB}	80	100	Vdc
Emitter-Base Voltage	V_{EB}	5.0		Vdc
Collector Current — Continuous Peak	I_C	10 15		A dc
Base Current	I_B	0.25		A dc
Total Device Dissipation @ $T_C = 25^\circ\text{C}$ Derate above 25°C	P_D	70 0.56		Watts W/ $^\circ\text{C}$
Operating and Storage Junction Temperature Range	T_J, T_{stg}	-65 to +150		$^\circ\text{C}$

THERMAL CHARACTERISTICS

Characteristic	Symbol	Max	Unit
Thermal Resistance, Junction to Case	$R_{\theta JC}$	1.78	$^\circ\text{C/W}$

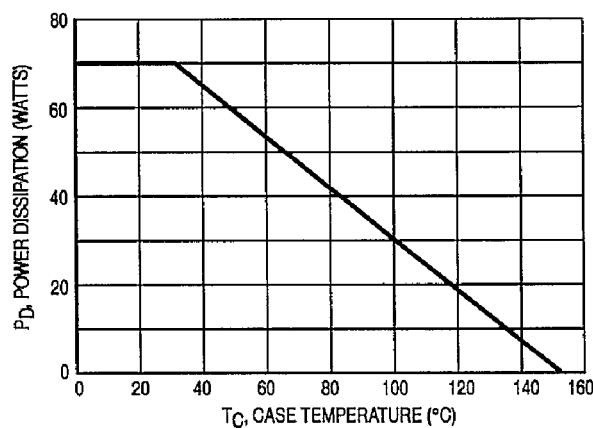
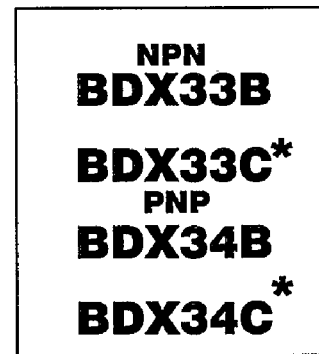

Figure 1. Power Derating

Preferred devices are Motorola recommended choices for future use and best overall value.

REV 7



*Motorola Preferred Device

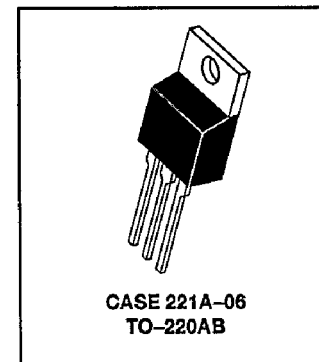
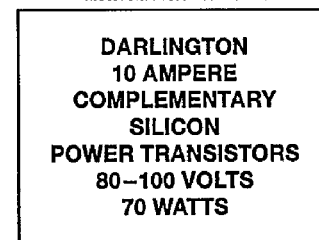

BDX33B BDX33C BDX34B BDX34C

ELECTRICAL CHARACTERISTICS ($T_C = 25^\circ\text{C}$ unless otherwise noted)

Characteristic	Symbol	Min	Max	Unit	
OFF CHARACTERISTICS					
Collector-Emitter Sustaining Voltage ¹ ($I_C = 100\text{ mAdc}$, $I_B = 0$)	BDX33B/BDX34B BDX33C/BDX34C	$V_{CEO(sus)}$	80 100	— —	Vdc
Collector-Emitter Sustaining Voltage ¹ ($I_C = 100\text{ mAdc}$, $I_B = 0$, $R_{BE} = 100$)	BDX33B/BDX34B BDX33C/BDX33C	$V_{CER(sus)}$	80 100	— —	Vdc
Collector-Emitter Sustaining Voltage ¹ ($I_C = 100\text{ mAdc}$, $I_B = 0$, $V_{BE} = 1.5\text{ Vdc}$)	BDX33B/BDX34B BDX33C/BDX34C	$V_{CEX(sus)}$	80 100	— —	Vdc
Collector Cutoff Current ($V_{CE} = 1/2$ rated V_{CEO} , $I_B = 0$)	$T_C = 25^\circ\text{C}$ $T_C = 100^\circ\text{C}$	I_{CEO}	— —	0.5 10	mAdc
Collector Cutoff Current ($V_{CB} =$ rated V_{CBO} , $I_E = 0$)	$T_C = 25^\circ\text{C}$ $T_C = 100^\circ\text{C}$	I_{CBO}	— —	1.0 5.0	mAdc
Emitter Cutoff Current ($V_{BE} = 5.0\text{ Vdc}$, $I_C = 0$)		I_{EBO}	—	10	mAdc
ON CHARACTERISTICS					
DC Current Gain ¹ ($I_C = 3.0\text{ Adc}$, $V_{CE} = 3.0\text{ Vdc}$)	BDX33B, 33C/34B, 34C	h_{FE}	750	—	—
Collector-Emitter Saturation Voltage ($I_C = 3.0\text{ Adc}$, $I_B = 6.0\text{ mAdc}$)	BDX33B, 33C/34B, 34C	$V_{CE(sat)}$	—	2.5	Vdc
Base-Emitter On Voltage ($I_C = 3.0\text{ Adc}$, $V_{CE} = 3.0\text{ Vdc}$)	BDX33B, 33C/34B, 34C	$V_{BE(on)}$	—	2.5	Vdc
Diode Forward Voltage ($I_C = 8.0\text{ Adc}$)		V_F	—	4.0	Vdc

¹ Pulse Test: Pulse Width $\leq 300\ \mu\text{s}$, Duty Cycle $\leq 2.0\%$.

² Pulse Test non repetitive: Pulse Width = 0.25 s.

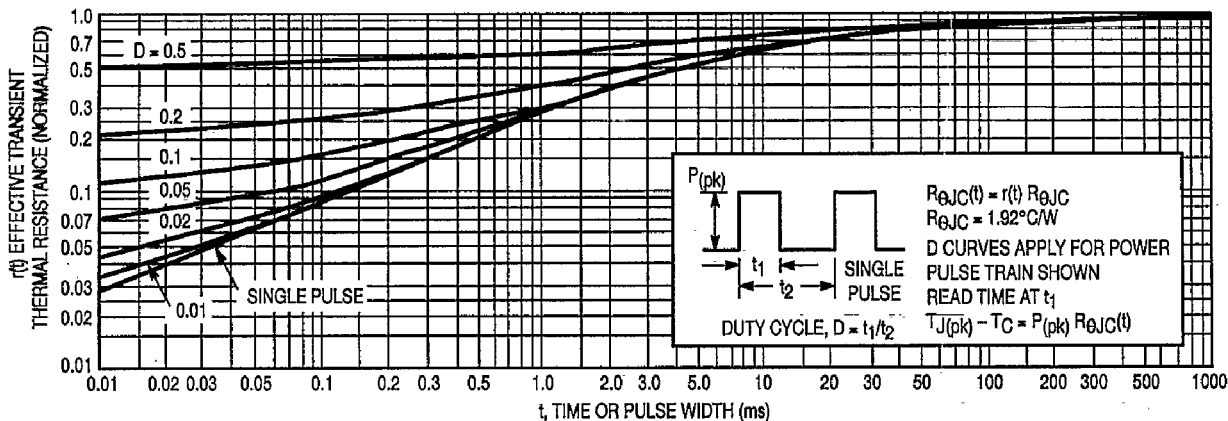

Figure 1. Thermal Response

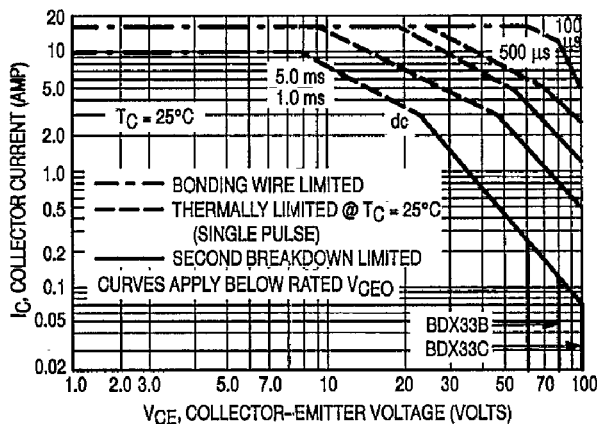
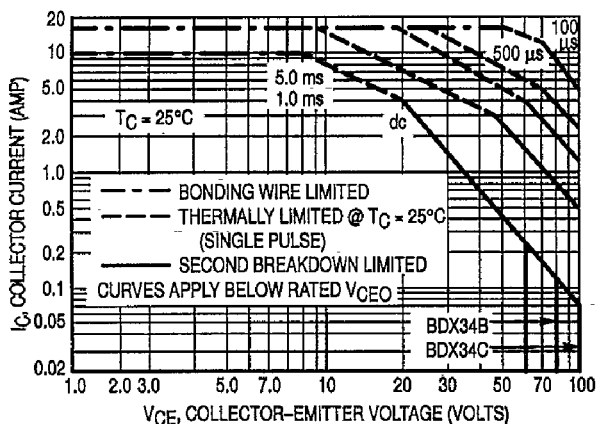

Figure 2. Active-Region Safe Operating Area

There are two limitations on the power handling ability of a transistor: average junction temperature and second breakdown. Safe operating area curves indicate $I_C - V_{CE}$ limits of the transistor that must be observed for reliable operation, i.e., the transistor must not be subjected to greater dissipation than the curves indicate. The data of Fig. 3 is based on

$T_{J(pk)} = 150^{\circ}\text{C}$; T_C is variable depending on conditions. Second breakdown pulse limits are valid for duty cycles to 10% provided $T_{J(pk)} = 150^{\circ}\text{C}$. $T_{J(pk)}$ may be calculated from the data in Fig. 1. At high case temperatures, thermal limitations will reduce the power that can be handled to values less than the limitations imposed by second breakdown.

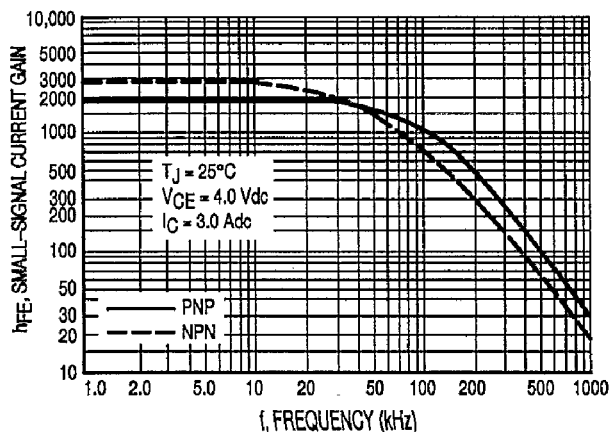

Figure 3. Small-Signal Current Gain

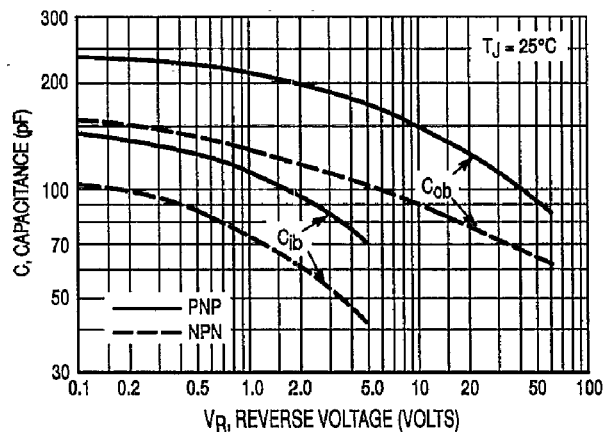
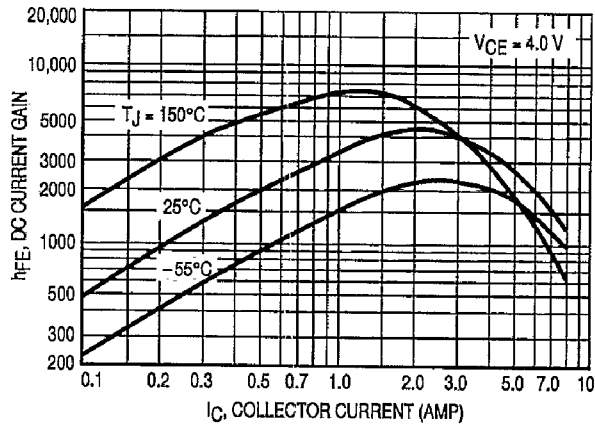

Figure 4. Capacitance

BDX33B BDX33C BDX34B BDX34C

**NPN
BDX33B, 33C**



**PNP
BDX34B, 34C**

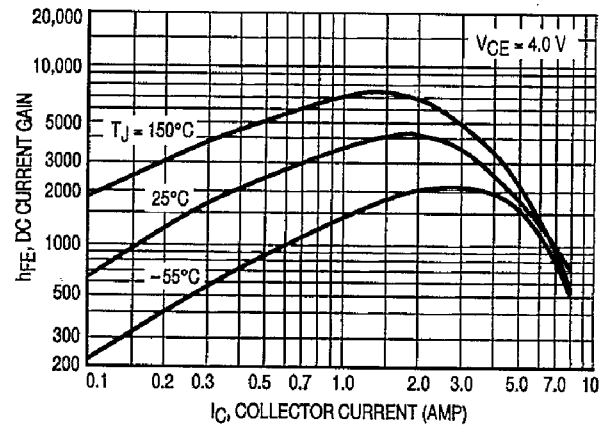

Figure 5. DC Current Gain

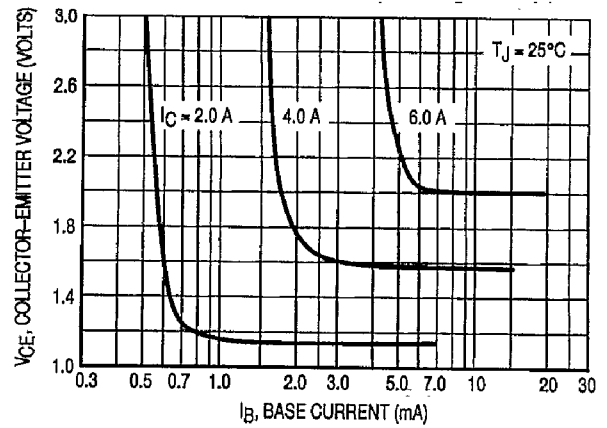
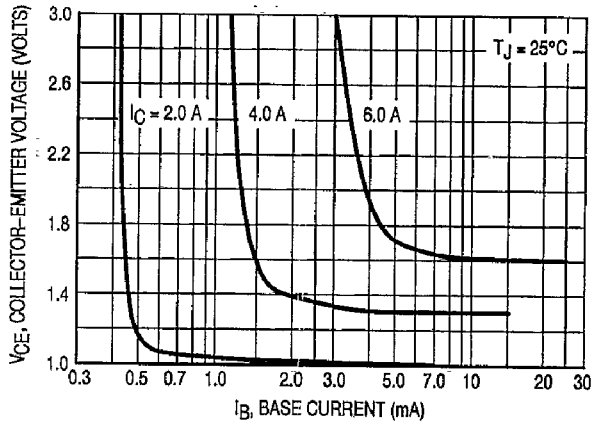

Figure 6. Collector Saturation Region

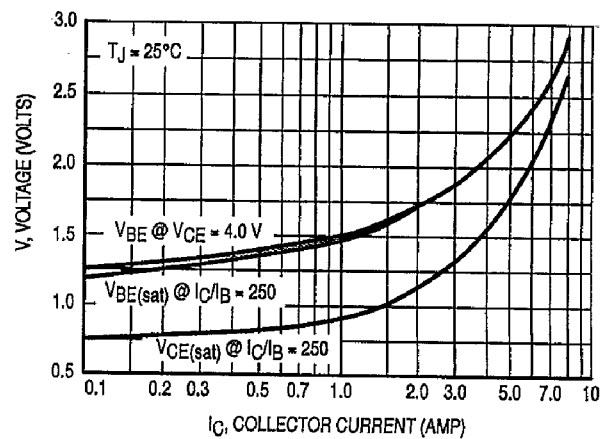
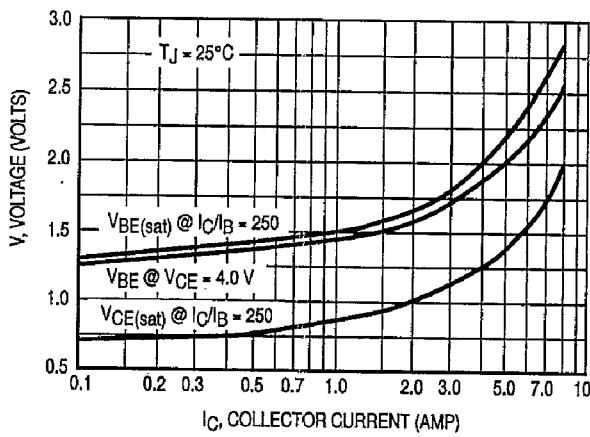

Figure 7. "On" Voltages